

The British Ecological Society

Brine Shrimp Ecology

A classroom-based introduction to
ECOLOGY

Secondary Science Key Stages 3 and 4
Scottish Stages S1 to S4

All materials in this book have been developed by

Michael Dockery
and
Stephen Tomkins

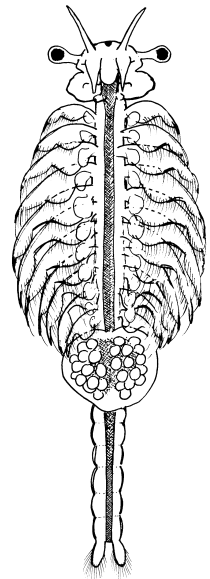
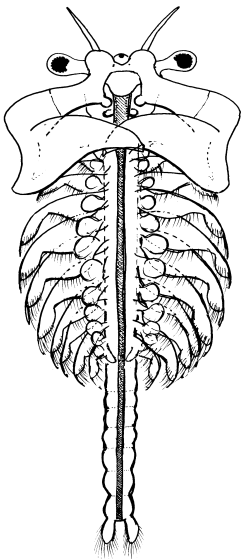

SCIENCE THROUGH ECOLOGY SERIES

Published by the British Ecological Society

The objective of the *Science through Ecology* series is to demonstrate that ecology can not only be taught as an investigative process as much as any other aspect of the Science National Curriculum but that, in fact, it offers a particularly exciting way to teach science. Each item in the series enables teachers who are not ecology specialists to get started in teaching the topic as a practical subject, with enough confidence to go on to develop it with enthusiasm and creativity.

Also in the same series: **Feeding Relationships** by Barker and Norris.

Other packages of teaching material in the series are proposed or already in preparation.

THE AUTHORS

Stephen Tomkins is Director of Studies for Biology at Homerton College and is the PGCE Biology Methods Lecturer for the Faculty of Education at Cambridge University. He was formerly a school biology teacher. He is interested in environmental education, science investigations in schools, genetics and human evolution.

Michael Dockery works (part-time) as the Education Officer for the Association for the Study of Animal Behaviour at Manchester Metropolitan University. He has taught for more than thirty years, from junior school to degree level and has co-authored books on animal behaviour which contain other brine shrimp practicals. He has been a member of the British Ecological Society for over twenty years.

THE BRITISH ECOLOGICAL SOCIETY

The British Ecological Society has a world-wide membership of over 5000, including many of the World's leading ecological scientists, and it is the oldest ecological society in the World. Education at all levels has long been seen by the Society as one of its important responsibilities. In addition to the *Science through Ecology* series, the Society offers teachers at all levels an opportunity to keep in touch with academic ecology, a careers booklet, a teachers newsletter, a specialist members' group for those involved in teaching ecology, and a range of grants and awards.

For further information see the BES web site:

<http://www.demon.co.uk/bes>

or contact:

The Executive Secretary,
BES,
26, Blades Court,
Deodar Rd,
Putney,
LONDON SW15 2NU.

Phone 020 8871 9797

Fax 020 8871 9779

Email general@ecology.demon.co.uk

AUTHORS' ACKNOWLEDGEMENTS

We should like to acknowledge the help of many teachers and colleagues, particularly Michael Reiss, and members of the British Ecological Society Education, Training and Careers Committee, most particularly David Slingsby, the principal Editor. We were assisted initially by the detailed research of Harriet Elson and helped throughout by technical support from David Barnard at Homerton College.

At the outset of the Brine Shrimp Project we were grateful to Cooperative Retail Services, Cambridge, for the provision of several hundred plastic bottles. Tom Wakeford then pioneered and encouraged Stephen Tomkins in the first 'Bottle Planet Workshops' at the Edinburgh Science Festival. We thank the many teachers who have suggested ideas at Brine Shrimp workshops and the staff and students at the following schools who have enjoyed working with brine shrimps and tried out investigations: Wakefield High School for Girls; Queen's School, Chester; Loreto College, Manchester; St Thomas Aquinas Upper School, Chorlton; Urmston Grammar School; All Saints Primary School, Sale; Impington Village College; Swavesey Village College; Norwich High School for Girls and Hinchingsbrooke School. We would also like to thank, in particular, the Headmistress and Year 10 students at Alderley Edge School for Girls. Sue Barker, Gary Skinner and John Davenport are thanked for their valuable comments on the first manuscript. We are also most grateful for the support for Michael Dockery which came from Professor Terry Looker, at Manchester Metropolitan University.

This book has been developed jointly by the British Ecological Society and Homerton College, Cambridge.

Picture credits

Stephen Tomkins provided all the line illustrations. The figure on page 31 is by courtesy of the Royal Society and that on page 69 by courtesy of the Institute of Biology. The brine shrimp photograph on the front cover is with permission from the Laboratory of Aquaculture and the *Artemia* Reference Centre at the University of Ghent. Michael Dockery provided the photograph of pupils, the other photographs were provided by the Natural History Photographic Agency.

Copyright & photocopying

The British Ecological Society retains the full copyright on all the materials in this publication but any pages may be freely photocopied or electronically copied within an institution purchasing this book.

First published by the British Ecological Society 2000.

Designed by Martin Hodge, MNL, mnl@itl.net.

Printed by Solutions for Business, Royston.

ISBN 1 900579 10 3

CONTENTS

Section 1. Introduction to the brine shrimp model ecosystem

Introduction	1
--------------------	---

Section 2. Practical activities. Student activity sheets and teacher's notes

Student activity sheets

Handling and observing brine shrimps	6
1 Shrimp world - looking at the brine shrimp environment	7
2 Variation in brine shrimps	10
3 The hatching of brine shrimps - investigating physical factors	12
4 The first food - filter feeding for beginners	18
5 Testing the algal food hypothesis	21
6 Shrimps galore - setting up your own bottle ecosystem	23
7 Exploding populations	27
8 Predatory shrimping	29
9 Are shrimps vertical commuters?	32
10 Speedy shrimps - fleeing and finding a mate	35
11 Altering the balance - pollution studies	37
12 The sun-seekers - let there be light	39
13 Now go ponding - investigating the biology of 'water-fleas'	44

Teacher's notes for student activities 1-13

Activity 1: Shrimp world - looking at the brine shrimp environment	50
Activity 2: Variation in brine shrimps	51
Activity 3: The hatching of brine shrimps - investigating physical factors	52
Activity 4: The first food - filter feeding for beginners	53
Activity 5: Testing the algal food hypothesis	55
Activity 6: Shrimps galore - setting up your own bottle ecosystem	57
Activity 7: Exploding populations	58
Activity 8: Predatory shrimping	59
Activity 9: Are shrimps vertical commuters?	61
Activity 10: Speedy shrimps - fleeing and finding a mate	62
Activity 11: Altering the balance - pollution studies	63
Activity 12: The sun-seekers - let there be light	64

Activity 13: Now go ponding - investigating the biology of 'water-fleas'	65
--	----

Section 3. Secondary data exercises

Teacher's guide	68
-----------------------	----

Student data exercises

1 Brine shrimps all around the world	69
2 Salt and survival - the cost of living in a very salty place	70
3 Temperature effects - too hot, too cold	72
4 The daily cycle of chemical change	74
5 The brine shrimp sex balance	75
6 Copper - contamination and pollution	76
7 Brine shrimps in space - Apollo 16.....	78
Answers to data exercises	79

Section 4. Illustrations for photocopying

Drawings of brine shrimps	83
---------------------------------	----

Section 5. The practical brine shrimp guide

How to set up a brine shrimp culture	92
Brine shrimp life history - background information	93
Handling brine shrimps in the classroom - practical tips and ethical issues	95
The laboratory technician's guide.....	96
Sources of supply for teaching materials	99

Section 6. Additional notes in support of teaching and assessment

Brine shrimps and Science 1 investigations	102
Ecology notes for science teachers	105
1 Introducing ecosystems	105
2 The brine shrimp ecosystem.....	106
3 Energy flow, nutrient cycles and nutrient sinks.....	108
4 Population ecology - boom and bust	109
5 Pollution - water pollutants and harm to ecological systems	111
Bibliography	113
General references on ecology	113
Selected references to research papers and publications on the ecology of the brine shrimp, <i>Artemia</i>	113
References to World Wide Web sites	114

Section 1

Introduction to the brine shrimp model ecosystem

INTRODUCTION

Seeing is believing: ecosystems made easy

Whatever the age or ability of the students, the first encounter with a bottle ecosystem conveys much more than several pages in a text book. All sorts of difficult concepts suddenly become obvious because so much happens before your eyes. Like a rainforest, the bottle contains **primary producers** (microscopic algae), **primary consumers** (the brine shrimps), and **decomposers** (micro-organisms). Provided the bottle ecosystem has an external source of **light energy** it is **self-sustaining**. The brine shrimps never need feeding and never run out of oxygen because the algae on which they feed carry out **photosynthesis**, grow and multiply by **asexual reproduction**. The algae never run out of carbon dioxide, water or mineral salts because they are **recycled**. There are micro-organisms in the water which cause **decay** of dead algae, dead shrimps, shrimp droppings and even dead micro-organisms. When the **population density** of brine shrimps is low there is abundant food - everyone can see the green colour of the water. The brine shrimps can be seen mating and eggs can be seen, which soon hatch. The population increases **exponentially** until mounting **competition** for food (the green colour of the water disappears) halts further expansion. The populations fluctuate in a way reminiscent of the text book **predator-prey** graphs (although this is actually a **grazing** example) and over time may tend towards an **equilibrium**.

This book offers you:

- Information on how to set up your Bottle Ecosystem and how to look after it
- Student activity sheets for 13 practical activities
- Teacher's notes for each practical activity
- Secondary data analysis exercises for extension work and homework ideas with answers and teacher's notes
- Background information for students planning investigations
- Photocopiable illustrations for students or to make into overhead transparencies
- Brine shrimp investigations for course work assessment
- Background ecological information for teachers
- Laboratory technician's guide.

The brine shrimp ecosystem is effectively a salt lake community in an aquarium on the sunny side of the lab. In winter the organisms in it may need extra heat or light, but, once built up, the community is essentially a self-sustaining entity; indeed, the tank

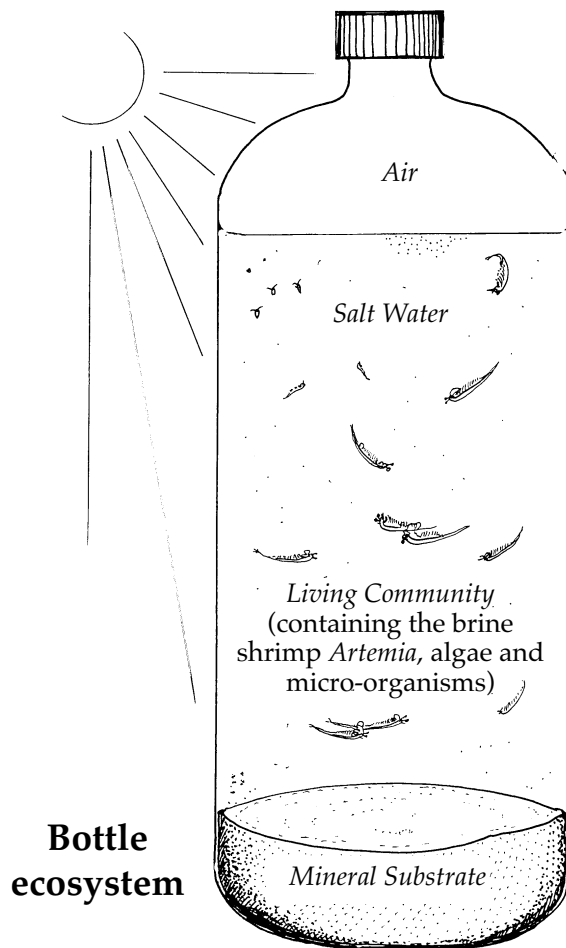

(like a salt lake) even has the advantage of being able to dry up completely and be revived. From a parent brine shrimp tank smaller shrimp ecosystems in plastic bottles may easily be set up. Students can take home these bottle ecosystems. They are virtually costless and provide an enduring source of fascination. Whilst the individual shrimps and small ecosystems may eventually 'die', the larger tank system endures and cultures from it have spread from school to school over more than a decade. This is the material resource behind this book.

Brine shrimps and the science curriculum

It is hoped that this book will be found useful by those who teach ecology as part of the science curriculum or of environmental education at many levels throughout the World. It was, however, originally developed to address the Science National Curriculum of England and Wales for pupils at Key Stage 3 (11-14 years of age) and Key Stage 4 (14-16 years).

The Brine Shrimp Ecology book

- provides an investigative laboratory based approach to practical work
- supports the teaching of knowledge and understanding of ecology within the science curriculum
- offers opportunities for course work assessment. *

Investigative practical work

The Brine Shrimp Ecology book is essentially focused on **investigations**. Many of the classroom or laboratory activities are set out as directed investigations. Here students get the opportunity to learn about techniques, hypothesis testing, controlling and manipulating variables, handling and analysing data, and the evaluation of conclusions. Other activities are less prescriptive and encourage a more individual approach, with the possibility of assessment in some, if not all, of the Science 1 skills. From this, students can progress to whole investigations with access to the highest levels. Here again this book supports them by providing a mine of secondary sources, both as background information and references, as well as details of techniques. The use of Brine Shrimp Ecology investigations for assessment specifically within the National Curriculum of England and Wales is further discussed in section 6, which includes some exemplar material.

Biological science knowledge and understanding

The exercises in this book support the teaching of the following ecological concepts:

- ecosystems
- adaptation to environment
- abiotic factors in ecosystems
- food chains, energy and biotic interactions
- reproduction
- population dynamics: competition and predation
- photosynthesis and requirements for plant growth
- importance of micro-organisms in decay and recycling
- effects of pollution on ecosystems.

* the word 'assessment' refers here to a type of teacher-assessed investigative practical work which contributes towards the final grade in the General Certificate of Secondary Education (GCSE), a public examination taken in a number of subjects, including Science, at age 16 at the end of statutory education in England and Wales.

Risk advice



This symbol draws attention to a potential hazard which a teacher would be advised to consider in his or her risk assessment. Whilst every effort has been made to make sure that the activities in this book are safe in normal teaching conditions neither the authors nor the publisher can accept any liability for injuries suffered while carrying out these activities. It remains the responsibility of the teacher working within the policy statements of the school to do a risk assessment depending on particular circumstances. An activity which can be relatively safe in one situation may be considered too dangerous in another.

Animal welfare issue

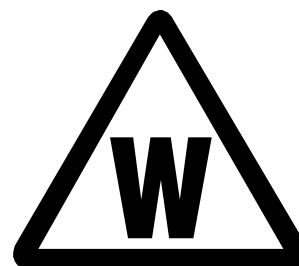

This symbol draws attention to a possible animal welfare issue which a teacher may wish to consider before undertaking an activity, or may wish to discuss with her or his class before embarking on it. It is hoped that none of the activities in this book lead to stress or other suffering of brine shrimps, but the final decision rests with the teacher. Our experience has been that students become quite fond of their shrimps and that the activities usually increase not only their fascination but their respect for living animals, both from conservation and welfare points of view.

Photocopying

Although the British Ecological Society retains copyright on all these materials they may be freely photocopied within an institution purchasing the book.

Section 2

Practical activities

Student activity sheets and teacher's notes

HANDLING AND OBSERVING BRINE SHRIMPS

Brine shrimps are very delicate animals and you must take care not to harm them when you handle them. When supported by the salt water they are quite tough.

Sieving and straining

The best way to catch shrimps from a tank is to go fishing for them with a fine sieve. Gently wash them from the upturned sieve with a little salt water into another container.

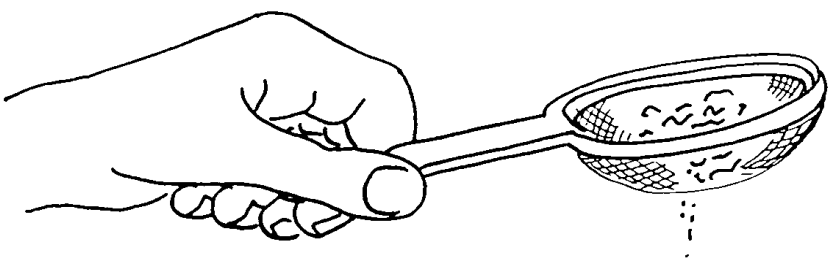

If you pour water containing shrimps through a handkerchief that is supported by a funnel, it will separate all the shrimps and eggs and tiny larvae from the water. However, most of the algae will pass through a cotton or linen handkerchief.

Sucking up a shrimp



To pick up a shrimp from the water use a pipette. The most suitable pipettes are made of soft plastic. Cut off the pointed end of the pipette so as to make a tube that is wide enough for the adults to enter. This should have a hole 3-5 mm wide. When sucked up, the shrimp will not be distressed and will not escape from the water.

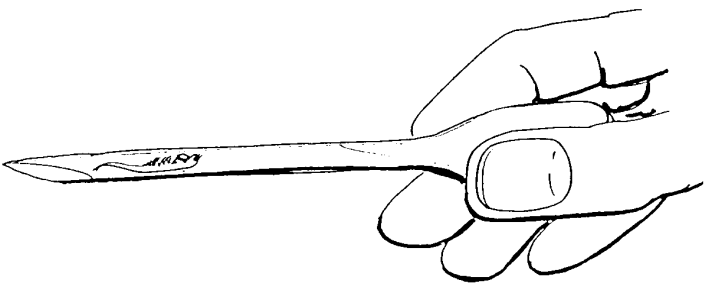

Putting a shrimp on a microscope slide



Take a clean glass slide and gently rub it dry and shiny. Put just a few drops of salt water with a shrimp onto the slide. Suck up any extra water so that the shrimp is confined in a blob of water. This must not dry up, so add just one drop of water every minute or two. If you place this slide beneath a low power microscope you can observe the shrimp in more detail. Release the shrimp back into its tank after no more than five minutes.

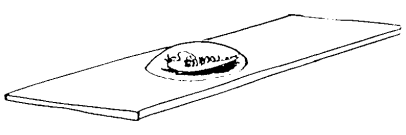

1: SHRIMP WORLD - looking at the brine shrimp environment

The Challenge

In this class you are going to study a brine shrimp environment. We may begin to learn something about **ecology** by looking at this environment in the classroom. Suppose that you were the first person to discover this new environment. How would you begin your investigations? What are brine shrimps? Where do they live? What do they look like? What do they eat? How do they reproduce? What eats them? What is their environment like physically?

Apparatus that you need

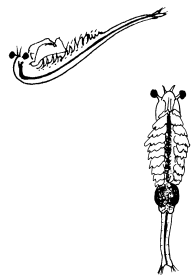

In your school you may already have a brine shrimp tank and some brine shrimp bottles. What you need for observing and recording is time to spend looking at these and then time to spend recording your observations. You will need to watch and make drawings and notes. You may be working on your own or be in a group. All you need is:-

- a brine shrimp tank or plastic bottle
- a recording sheet
- a stop watch or clock
- a thermometer, some pH papers and a hydrometer.

Procedure for brine shrimp watching

1. Spend **three minutes** looking at the bottle and its contents.
2. Write down **seven** things that you have noticed about the brine shrimps on your recording sheet.
3. Discuss your **observations** with your neighbour. What did they notice that you didn't see?
4. Discuss your **observations** with your teacher and the rest of the class.
5. Draw a diagram of one brine shrimp. (A hand lens would help you here).
6. Draw an outline of the bottle on your recording sheet and trace on it where **one shrimp goes in one minute**.
7. Find out the temperature of the tank or bottle, its pH and the relative density of the water. (You may need to ask your teacher how to use the hydrometer.)

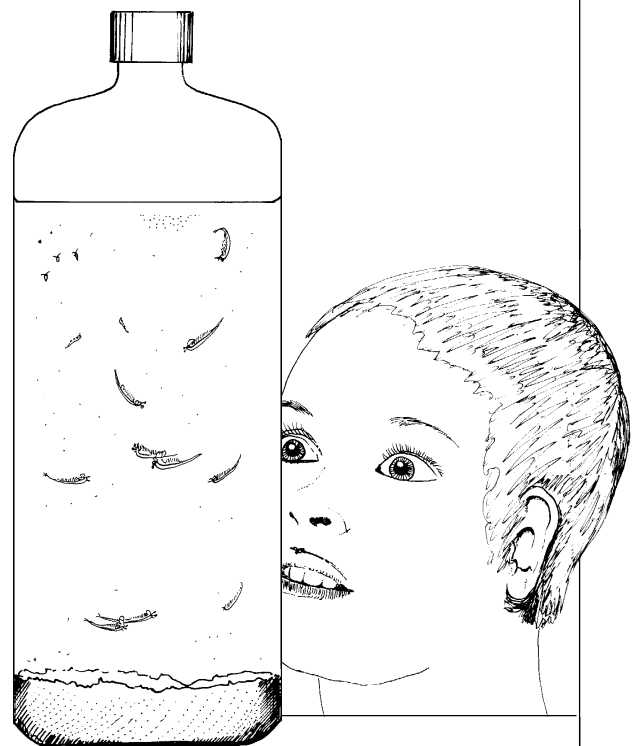

BRINE SHRIMP WORLD - THE FACTS

Brine shrimps are found all around the world in **salt lakes**. These are places, often in hot countries, where rivers end in a lake instead of going to the sea. The sea is salty because it has had salts flowing from the land into it for hundreds of millions of years. As salt lakes may dry up completely in the hottest season they can become just a flat white **salt pan**. Sea water has 35 grams of salt per litre. Some salt lakes, like the Dead Sea, have 8 times as much salt as this and so have a **high relative density**.

Brine shrimps have a **head**, a **middle** (thorax) and a **tail** (abdomen). Brine shrimps usually move about on their backs, **upside down** with their **leafy-legs** uppermost, unlike other more familiar crustaceans such as woodlice. The eleven pairs of leafy-legs are used as filters, for swimming along in the water and as gills. On the front of the head are two little black **eyes**. There are also two **small antennae** which stick out forward. These are hard to see without magnification. These are sensory structures for feeling the environment ahead. Further back are two **large antennae**. Young shrimp larvae are called **nauplii** (*nor-plee-ee*). They grow up in about two to four weeks. When nearly fully grown the sexes may be told apart quite easily.

In the **male** the second antennae develop into large, hooked **claspers**. The males have a translucent body and are sometimes greeny-blue. The **females** are brown/red in colour and have a bundle of eggs in a **brood-pouch** half way along the body. In the brood-pouch eggs are fertilised and protected by the mother. When males and females are adult they pair up. These **tandem pairs**, of a female at the front and a male behind, go around together, like people on a bicycle made for two. In this position the two animals swim for many hours, and even days.

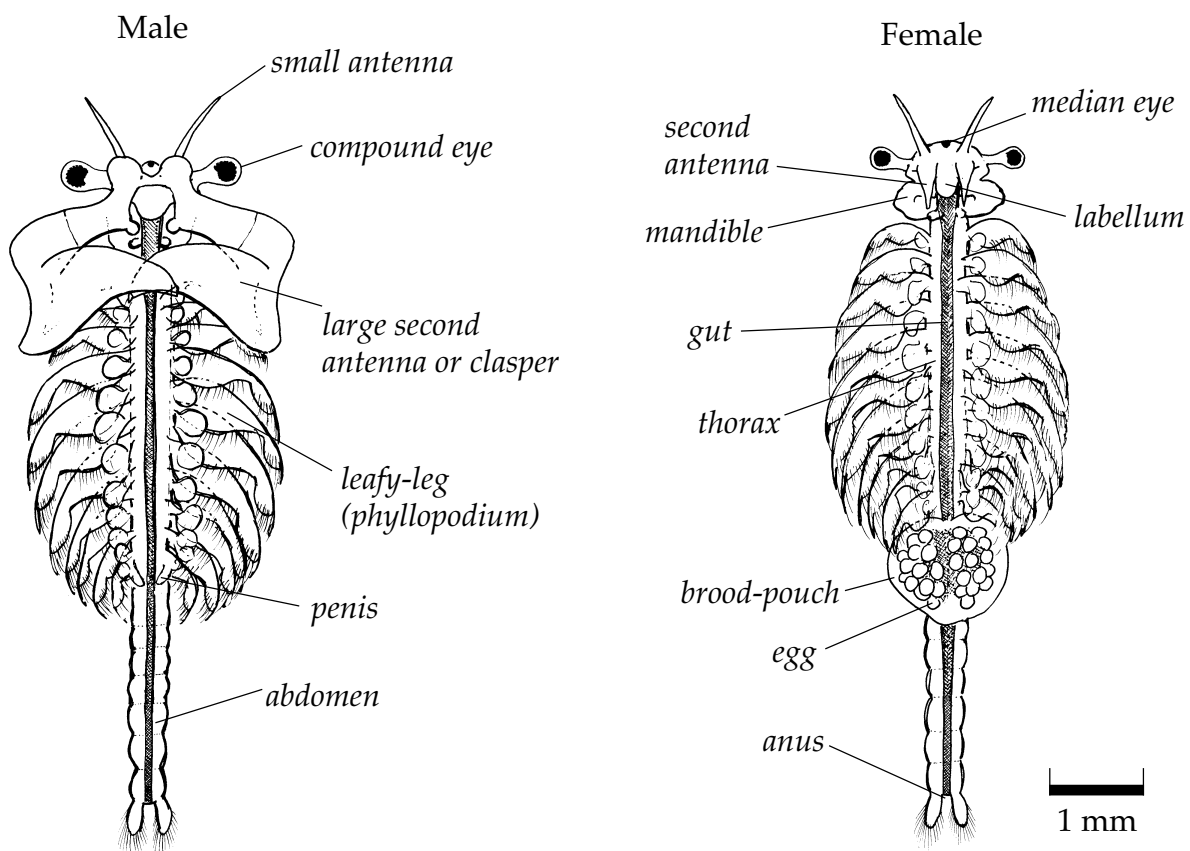

Know your brine shrimp anatomy

A famous place that brine shrimps live is the **Great Salt Lake**, Utah, U.S.A., just beside Salt Lake City. Once a year the lake goes brown on the top with small brown particles. These are the egg-cysts produced by the brine shrimps. These **egg-cysts** drift in the wind and waves to the shore in huge numbers. Here they dry up and do not hatch until the wet season. At the first rains in April the eggs hatch. From each one out comes a little **nauplius** larva: soon the **nauplii** (plural) begin swimming and the lake becomes full of them again.

What eats what in the brine shrimp world?

Shrimp larvae grow quickly but it is hard to see what they are eating. Their leafy-legs **filter** their food out of the water. Food chains begin with **sunshine** and a **green plant**. The brine shrimp food chain starts with single celled plants called **algae**. These microscopic green plants are found in the water and, in large numbers, make it a green colour. The number of algae may double every day, so that 2, 4, 8, 16, 32 cells may come from just 1 cell in 5 days. They grow most in bright **light** and with lots of **mineral nutrients**. The reason that you may not see the algae easily is that they are very small and the brine shrimps eat them up almost as fast as they can reproduce! In salt lakes the brine shrimps are in the food chain themselves. The natural predators of the brine shrimp are birds like **flamingoes**, **grebes** and **avocets** that fly in to visit the salt lake. Fish also like to eat brine shrimps but just don't often get a chance. Salt lakes are often so salty that fish cannot live there. Without the predatory fish and birds brine shrimp numbers are often very high. There may be a hundred adult shrimps in a litre of water.



Algae (x 1000)

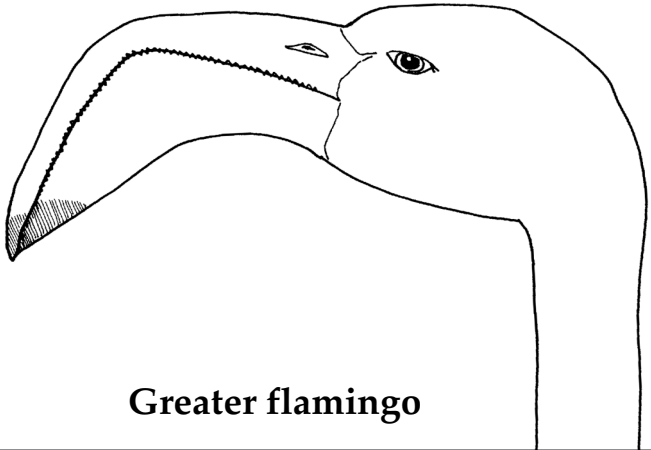

Greater flamingo

- More things to do or find out**
1. Label your own drawing of a brine shrimp.
 2. What exactly is brine? What happens to the relative density of water as you stir in more salt? Find out by an experiment. Does it get hotter when you add salt?
 3. Find out the names of three salt lakes. Find them in an atlas and record where they are.
 4. Classification. Which is the odd one out and why?
 a woodlouse, a brine shrimp, a snail, a lobster, a water flea.
 5. From your bottle watching, calculate how many brine shrimps are able to live in a litre of salt water. How many would live in a cubic metre?
 6. Why do shrimps swim in tandem pairs? Make a hypothesis.

2: VARIATION IN BRINE SHRIMPS

Background

Just like people, brine shrimps are not all the same. They vary, for example, in appearance, shape, length and speed of swimming in the water. Some of these characteristics are affected by inherited genes and some by influences in the environment. Your height might depend partly on the genetic characteristics you received from your parents and also on factors in your life such as diseases in childhood and the quality of your diet.

If you observe the brine shrimps swimming in their tank or bottle, you will notice that they vary in length. The aim of this investigation is to see how much variation there is in the length of adult male and female brine shrimps.

Are female and male shrimps similar in length, or do the sexes differ?

What would be a suitable hypothesis to test in this investigation?

Apparatus that you need



You will need the following pieces of equipment:

- the work card *Handling and observing brine shrimps* (see page 6)
- a clean glass microscope slide
- a low power microscope or powerful magnifier
- a small piece of 1 mm graph paper to put under the glass slide
- a plastic pipette - with a wide mouth to capture the shrimps from the tank
- two 250 cm³ glass beakers
- salt water
- ten adult shrimps, five females and five males.

Procedure - what to do

1. Put about 200 cm³ of salt water into each of the two glass beakers.

Then capture **ten shrimps** from the tank, using the pipette, and put them carefully into one of the beakers. Leave them to settle down in the beaker for a few minutes. Check that you have both males and females.

2. Pick up the glass slide and make sure it is clean. Using the pipette, **capture a female shrimp**. With the shrimp still in the pipette, put a few drops of water with the shrimp onto the slide. Suck up any extra water so that the shrimp is confined to a single blob of water in the middle of the slide.



N.B. It is most important that you do not harm the shrimp so make sure that this water does not dry up whilst the shrimp is on the slide.

3. Place the slide carefully under the microscope or magnifier and measure the length of the shrimp **twice**. Make sure that you take the measurements when the shrimp's body is straight. Write down the first measurement. Then turn the slide through 180° and take another measurement of its length. Record the second measurement. Work out the average of these two measures of the length of the shrimp.

4. To put the shrimp back in water, fill the pipette with salt water from a glass beaker. Put the slide with the shrimp over the second beaker and wash the shrimp off the slide and into the beaker.
5. Repeat this procedure to find the length of the other female and male shrimps.

Results

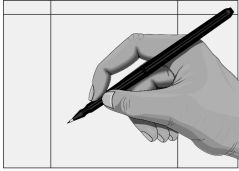

Put your data into a table like the one below and if other groups in your class have carried out similar investigations add their data to yours.

Choose an appropriate graphical technique to represent these data. You might wish to draw two graphs, one for the female shrimp data and one for the male shrimp data.

For each sex, find out the smallest and the greatest length of the shrimps in the sample and determine the range of lengths.

Do your results support your hypothesis?

	Females			Males		
	First measurement	Second measurement	Average length (mm)	First measurement	Second measurement	Average length (mm)
1						
2						
3						
4						

- Questions**
1. Are the average lengths of female and male brine shrimps the same, or do they differ?
 2. Is there a greater range of length in one sex rather than the other? If so, which sex has the greater variation?
 3. Can you suggest what factors may determine the body length of a brine shrimp?

Further work

When the female shrimps are under the microscope it is possible to count the number of eggs in their brood-pouch or sac. You could count the number of eggs and then see if there is a relationship between the number of eggs in a female’s pouch and her length. You could plot a scatter diagram for these data.

Do longer shrimps choose longer partner shrimps of the opposite sex? To answer this question, carefully capture some paired shrimps and measure their lengths. Why might a longer shrimp choose a longer partner?

3: THE HATCHING OF BRINE SHRIMPS - investigating physical factors

Background

Brine shrimps need a good start in life. They will not hatch from dormant egg-cysts unless all the conditions which they experience are like the wild environment to which they are adapted.

So, how can we find the best environment for young shrimps to hatch into?

To help answer this question we need to know about the natural home of the wild brine shrimp.

- Brine shrimps live in sub-tropical countries which are hot; the average temperatures are well above those in Britain. They are found in such places as Morocco (in North Africa), Iran (in the Middle East) and California (in the USA).
- The lakes they live in are slightly alkaline, not acid. They have a pH that is above 7.0.
- The salinity (saltiness) of these salt lakes may be quite high, as the water in the lakes often evaporates completely in the hottest season. Sea water has approximately 3.5 g salt for every 100 cm³ of water. Some salt lakes are less salty than the sea and some are more salty. They vary a lot.

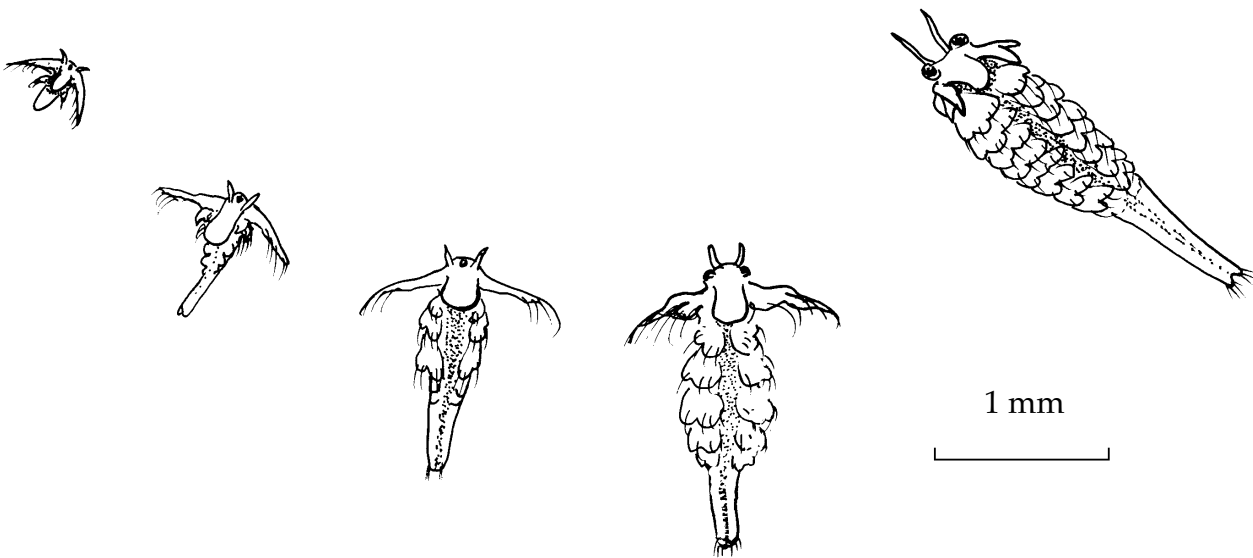

The shrimp hatch challenge

You are asked to carry out a **fair test** to find the best conditions in which young shrimps can hatch. The *very best* conditions will only be found by discovering what is *less than* the best for these animals.

Your teacher will divide the class into three shrimp-hatching research teams.

THE SALT TEST TEAM

Apparatus that you need

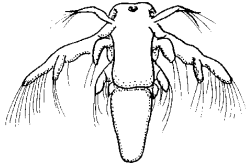

Each team will need:

- six 100 cm³ beakers or clear plastic cups
- sea salt
- a balance for weighing out salt
- 600 cm³ de-chlorinated* tap water
- a spatula for stirring
- a label for each beaker / cup.

Procedure - what to do

1. Label six 100 cm³ beakers and weigh or measure out into them some sea salt.

Label	Mass of salt
0%	0 g
1%	1 g
2%	2 g
3%	3 g
5%	5 g
10%	10 g

2. Add 100 cm³ of de-chlorinated tap water and stir it until the salt dissolves.
3. Next, when all the teams are ready, you need to add the egg-cysts.
For this you need the instruction sheet *Counting out shrimp egg-cysts* (page 16) and some more apparatus.
4. If you have time, repeat this test series. If your results are reliable you will expect to achieve similar results each time.
5. Put all the beakers in a warm place at 25° C.
6. Examine the beakers not less than 24 hours and not more than 48 hours later.

* Tap water is treated with chlorine to kill harmful micro-organisms. This chlorine may also harm the brine shrimps so it is important to leave tap water to stand in a bowl open to the air for at least 48 hours to allow the chlorine to escape. This is what is meant by de-chlorinated tap water.

THE TEMPERATURE TEAM

Apparatus that you need

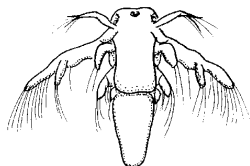

Each team will need:

- four 100 cm³ beakers or clear plastic cups
- sea salt
- a balance for weighing out salt
- 400 cm³ de-chlorinated water
- a spatula for stirring
- a label for each beaker / cup
- a refrigerator
- two water baths or incubators, or other warm places.

Procedure - what to do

1. Label four 100 cm³ beakers and weigh (or measure) out into each of them 2 g of sea salt.
2. Now add 100 cm³ of water to each and stir it until the salt dissolves.
3. Find out the temperatures of the four places you will investigate; they should range from cold to very warm.
4. Label the containers with the appropriate temperature.
5. The containers should be kept as follows:

Beaker	Place
5° C	In a refrigerator
20° C	In the lab (check this temperature)
30° C	In an incubator or water bath
40° C	In an incubator or water bath

6. Next, when all the teams are ready, you need to add the egg-cysts. For this you need the instruction sheet *Counting out shrimp egg-cysts* (page 16) and some more apparatus.
7. If you have time, repeat this test series. If your results are reliable you will expect to achieve similar results each time.
8. Examine the beakers not less than 24 hours and not more than 48 hours later.

THE PH TEST TEAM

Apparatus that you need

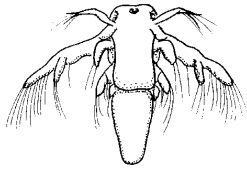

Each team will need:

- six 100 cm³ beakers or clear plastic cups
 - 600 cm³ of sea salt solution (2% in de-chlorinated water)
 - a spatula for stirring
 - a label for each beaker / cup
 - several pH test papers
- a pipette dropper bottle with 1 M sodium carbonate solution
 - a pipette dropper bottle with 0.1 M hydrochloric acid.

Procedure - what to do

1. Label six 100 cm³ beakers with the pH numbers in the table below.
2. Pour into each of them 100 cm³ of sea salt solution.
3. The salt water may not be neutral in pH. pH is a measure of acidity or alkalinity. It can be measured with the pH test papers by quickly dipping in the paper and checking with the pH colour chart. For each beaker you must first do a pH test.
4. Now add a few drops of EITHER dilute hydrochloric acid OR sodium carbonate solution to change the pH to the number on the label. Stir the beaker before testing with another paper.

Label	Acidity/alkalinity	Possible number of drops
pH 5	acid	2 drops of hydrochloric acid
pH 6	weakly acid	1 drop of hydrochloric acid
pH 7	NEUTRAL	perhaps no drops of either
pH 8	weakly alkaline	2 drops of sodium carbonate
pH 9	alkaline	8 drops of sodium carbonate
pH 10	very alkaline	20 drops of sodium carbonate

5. Next, when all the teams are ready, you need to add the egg-cysts. For this you need the instruction sheet *Counting out shrimp egg-cysts* (page 16) and some more apparatus.
6. If you have time, repeat this test series. If your results are reliable you will expect to achieve similar results each time.
7. Put all the beakers in a warm place at 25° C.
8. Examine the beakers not less than 24 hours and not more than 48 hours later.

COUNTING OUT SHRIMP EGG-CYSTS

Apparatus that you need

Each team will need:

- forceps
- scissors
- a small piece of graph paper
- a sheet of white paper
- a magnifier
- egg-cysts.

NOTE: The brine shrimp egg-cysts are so small that we need a special way of counting them. You need exactly a hundred eggs for a fair test to compare the different conditions.

Procedure - what to do

1. Tip a tiny pinch of eggs onto the large sheet of white paper. These are all you need for your experiment. For each test beaker you will need 100 egg-cysts. They are hard to count exactly, but here is one way that it can be done.
2. Cut out from a sheet of graph paper a piece about 3 cm x 4 cm.
3. Wet the graph paper a little with a few drops of salt water from the test container.
4. Dab it onto the white sheet to pick up about a hundred eggs. This will look like a tiny shake of pepper.
5. Now use a magnifier to count the number of egg-cysts exactly.
Cut the paper with scissors to make sure there are one hundred egg-cysts.
6. Put the paper with the 100 egg-cysts into your beaker (eggs-side down). After three minutes, using a pair of forceps gently remove the paper, making sure that all the egg-cysts have washed off into the water.

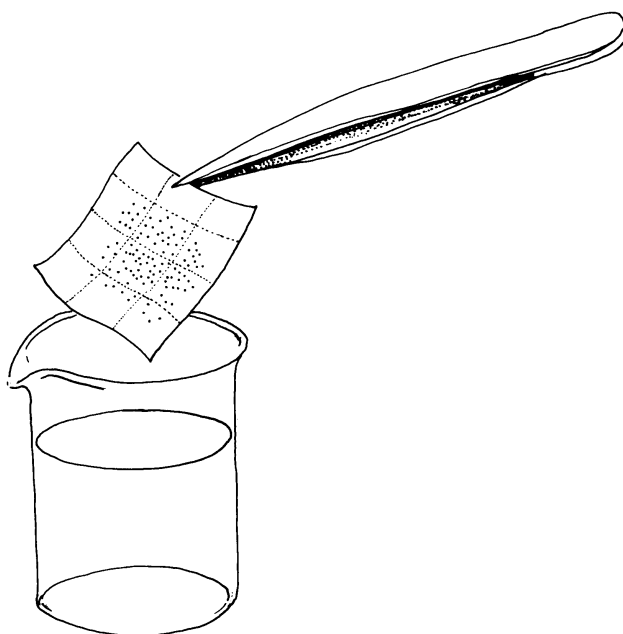

HOW TO COUNT THE HATCHED LARVAE

After two days some of your shrimps will have hatched. Brine shrimps hatch into a little larva called a nauplius (*nor-plee-us*). We need to know exactly how many have hatched in each container.

Apparatus that you need

Each team will need:



- a fine glass pasteur pipette (**HAZARD WARNING** - the glass pipette is sharp and dangerous if broken - be careful)

- a small beaker of salt water
- your beaker from the experiment
- a lamp or other source of bright light.

Procedure - what to do

1. Place a bright light next to your beaker, or place it so that the light is only coming from one side. If any brine shrimps have hatched they will swim to the light.
2. Using the fine pipette, count the hatched brine shrimps by catching them and put them in another small beaker.
3. Add the totals carefully and write down your results.

Results

Design a table for all the class results. Enter your results and those from others into the table.

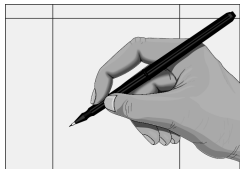

Questions

1. What were the optimum (best) conditions for hatching brine shrimps (i.e. for salt, temperature and pH) ?
2. Was this experiment a fair test?
3. How could the test have been made even more fair?
4. Your results show the number of shrimps hatched in each container. Why can this be described as a percentage hatch rate?

Now you can make up a hatching container where all the conditions are optimal. Hatch out some more shrimps for your shrimp-world aquarium. This time you will know that you are giving them the best home environment.

4: THE FIRST FOOD - filter feeding for beginners

Background

When the brine shrimps hatch from the egg cysts they soon begin to feed. They feed on tiny algal cells in the salt water. The nauplius at first uses its antennae to collect the food particles but, as it matures, the pairs of legs are used to move the particles to its mouth.

Like many animals that produce large numbers of eggs, not all the eggs hatch and, of those that do, not all the young shrimps survive. It has been suggested that one reason for the high mortality of the young is that there is not enough food of the right size available. One manufacturer (who grows brine shrimps to feed tropical fish) has produced a special liquid food called *Liquizell*, which consists of minute particles that are suspended in the water and are thus easily available to the shrimps. The manufacturer's claim is that, by developing *Liquizell*, they have "succeeded in nearly eliminating premature mortality of the nauplii". Yeast suspension is also sometimes used as a food source for young brine shrimps.

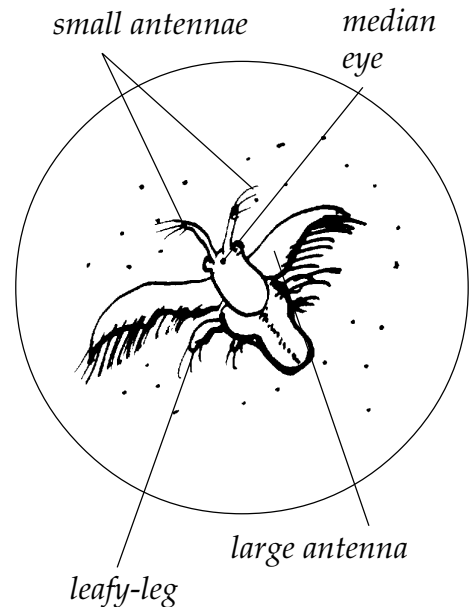

The Challenge

Do shrimps really have a higher rate of survival if fed *Liquizell*?

Your task is to design an experiment to test the claim of the manufacturer. For this, the class will be split into two halves: one half setting up beakers (or plastic bottles) of shrimps which will be fed *Liquizell* as well as natural algae, the other half having beakers which have only algae and do not receive *Liquizell*. Each half of the class will be sub-divided into pairs of students, each pair setting up just one beaker. The purpose of this is to provide a number of **replicates** of the two conditions, i.e. a set of beakers with *Liquizell* and a set without. This is because the results from 5-10 beakers will be more representative than simply relying on the findings from one beaker alone.

How would you state the class hypothesis that you are testing in this experiment?

Apparatus that you need

Your class will be divided into two teams; a '*Liquizell* team' and an 'algae team'.

Each pair within a team will need these sets of apparatus:

First set: For setting up the experimental containers

- a 250 cm³ beaker or open topped plastic bottle
- sea salt
- de-chlorinated tap water
- a balance for weighing out salt accurately
- a spatula for stirring
- a label for each beaker
- a dessert spoon
- substrate from the main brine shrimp tank
- a bottle of *Liquizell* (not needed by the algae team)
- a funnel, if plastic bottles are used rather than 250 cm³ beakers.

Second set: For counting out newly hatched larvae into the beaker

- a small beaker of nauplii
- a small glass pipette
- a bench lamp.

Third set: For counting the surviving larvae

- the 250 cm³ beaker used in the experiment
- a pipette
- a bench lamp
- a 100 cm³ beaker to receive larvae
- a calculator to work out the percentage survival.

Procedure

1. Put 200 cm³ of de-chlorinated tap water into the large beaker and then add 6 g of sea salt. Stir in well using the spatula (alternatively add the salt water already prepared).
2. Add to the beaker one level dessert spoon of substrate from the main tank, this will contain some algae. Stir it in well.
3. Add exactly 100 newly hatched shrimp nauplii. Count them in carefully.
4. '*Liquizell* Team'

Write your name and **Algae and *Liquizell*** on the label and stick it on the beaker. Add ten drops of *Liquizell* to the beaker, using the dropper on the bottle.

'Algae team'

Write your name and **Algae only** on the label and stick it on the beaker.
Add nothing more to the beaker.

- Put the beakers on a tray in a warm, well-lit place in the laboratory.
- Leave the beakers in the laboratory for a week on a sunny window sill or under a lamp. If possible count the number of larvae that are still alive after 24-48 hours (1-2 days), 72-96 hours (3-4 days) and 168 hours (one week later). Count the larvae using the same method outlined in the procedure of practical 3 (see page 17), with the equipment that is listed above.

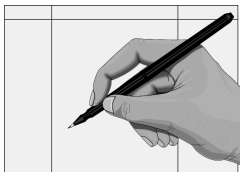
Results

You will need to design a table to contain all the class results under each of the two conditions for each of the three suggested time periods. Record the number of larvae in each beaker, for each time period, and then convert both these into percentages. Calculate the average number of shrimp larvae (and percentage) that survive under the two conditions, for each time period.

Plot these data on graphs, one for the *Liquizell* group and one for the non-*Liquizell* group, using the same scales for each graph.

Does the evidence appear to support the claim of the manufacturer?

Questions

- What did the manufacturer mean by "premature mortality of the nauplii"?
- What improvements to the experimental design might make this test fairer?
- Which variable is probably the least controlled in the experiment and what could you do to try and bring it under greater control?
- Suggest a follow-up experiment, using the *Liquizell* feed, and specify what hypothesis you would be testing in this follow-up study.
- Design an experiment to discover the conditions which most favour the small algae that the nauplii feed on.



5: TESTING THE ALGAL FOOD HYPOTHESIS

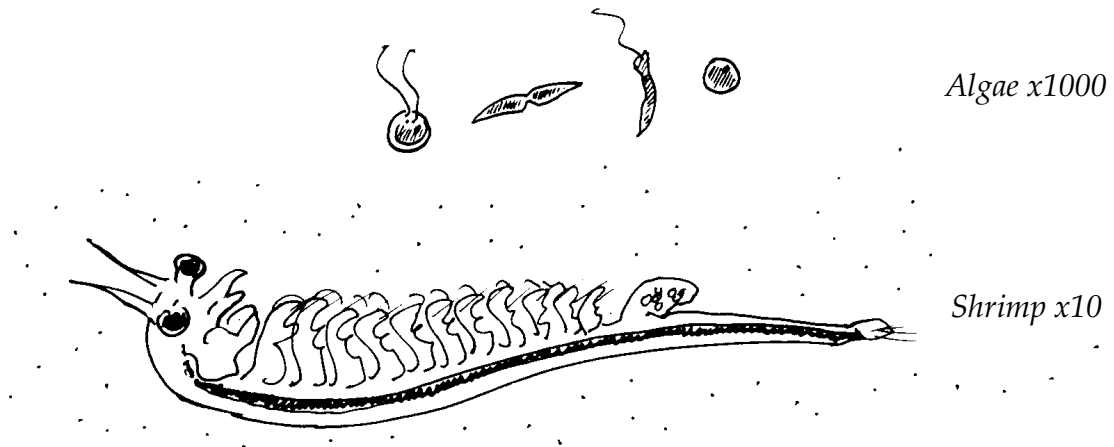

The Challenge

You may now have done some experiments to find out what young brine shrimps need to hatch and grow. What did you discover? What do the adults eat in the brine lakes?

Don't they feed on *algae* in the water?

If you say "Yes" well..... Do you believe this only because **you have been told that it is true**? Perhaps shrimps live on sunshine or salt. Perhaps they are cannibals and eat each other!

It would be a **good hypothesis** to suggest that they do eat algae because we can see nothing else that they could eat. But does that prove it?

How could you **test the algal food hypothesis**? How can you be really sure that green algae are their food ?

Background

Facts about algae that may help your investigation

- Adult brine shrimps will not go through a fine sieve but the larvae, eggs and algae will. The eggs and larvae will not go through a cotton cloth but the algae are so small that they will go through. So, the algae can be separated from the brine shrimps.
- Algae are often **green** in colour. The amount of green colour could be measured against a white background with a **colour chart**. (The green in a small test-tube sample may also be measured with a piece of apparatus in your school called a **colorimeter**).
- Algae are very small and can only be seen individually through a **microscope**. With a microscope they can be counted.
- Shrimps have a see-through body. You can see with a **microscope** what is inside their gut.
- Like all green plants, algae also need **light** to grow. They cannot grow in the dark.
- Like all green plants, algae also need **minerals** to grow. If shrimps eat algae, will plant fertilisers help shrimps to grow?
- The algae reproduce very quickly.

Planning your investigation

You are asked to plan, carry out and evaluate an investigation that will find out whether adult shrimps do or do not feed on algae.

Discuss what investigation you might make. Plan the investigation. Will you have enough shrimps, salt water and bottles? It might take a few weeks to be sure of the answer. Meanwhile you could also do some other experiments. Scientists have to be very patient. After you have thought about the investigation, answer these planning questions.

Planning questions

- What is your plan for the investigation ?
- What do you think will happen?
- Using your science knowledge, can you explain why you think this will happen?
- Will there be more than one experiment?
- What will you change between different experiments?
- What will you keep the same in an experiment?
- What would make any experiment a fairer test?
- What apparatus will you need?
- What will you measure?
- How will you measure these things?
- What observations are important to make?
- How many measurements/observations will you make?
- How long will you need to leave the experiment running before you record the results?
- Do you think there are any safety precautions you need to take?

Procedure

1. Make a list of the apparatus you need.
2. Make your experimental plan.
3. Decide when and how you will collect your results.
4. Conduct your experiment.

Results

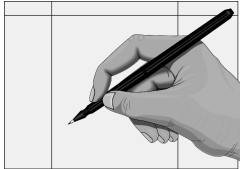

1. Collect your written observations and drawings.
2. Put any quantitative measurements first into a table.
3. Express your results as a picture, diagram, bar graph or line graph.
4. Decide how you will record any odd results.

The report



1. Write about what you think your results show.
2. Explain why your results fit your prediction, if they do.
3. Say what the odd results were and why they might have happened.
4. Evaluate your experiment. What improvements would you make were you to do it again? Make suggestions for further investigations.

6: SHRIMPS GALORE - setting up your own bottle ecosystem

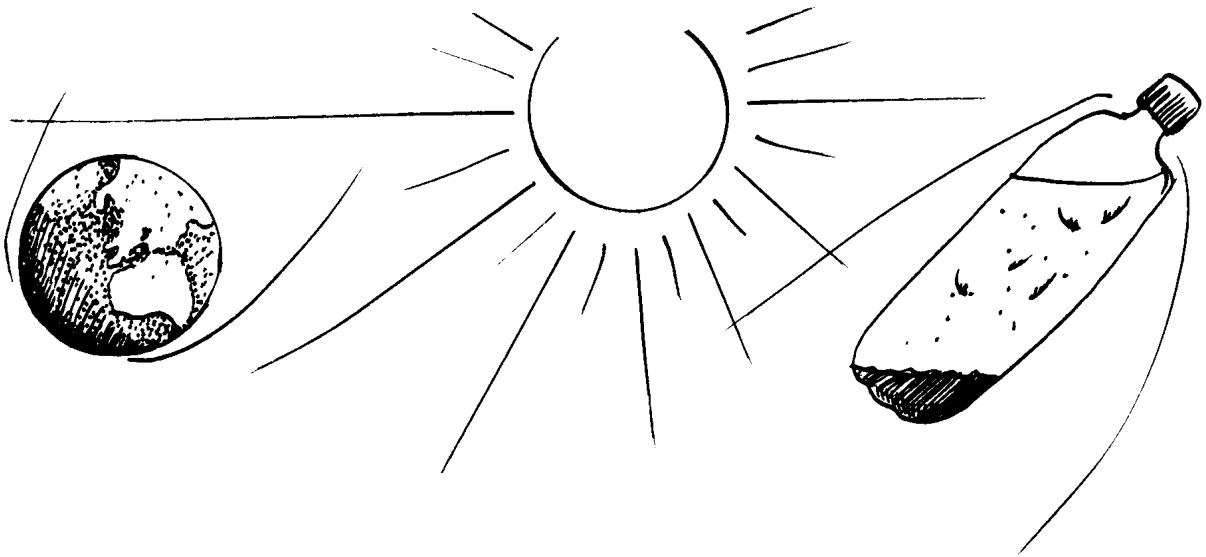

Background

What have the living world and a bottle of brine shrimps in common? Answer! Both of them have ecosystems. The world has one grand ecosystem and the bottle of brine shrimps has an artificial mini-ecosystem.

The Earth has rocks (land), sea and an atmosphere. Living things are found on the planet. All the green plants on the Earth are kept alive by light from the sun. This provides the plants with energy for photosynthesis. The plants grow and form the start of a food chain which feeds all the animals. When animals and plants die, their remains rot and decompose and atoms (of the elements) and molecules (of different sorts) are recycled in the ecosystem. These go back to help the plants to grow again.

The shrimp bottle has rocks and shell at the bottom, salt water and an atmosphere at the top. Living things are found in the bottle. All the green algae in the bottle are kept alive by light from the sun. This provides the algae with energy for photosynthesis. The algae grow and form the start of a food chain which feeds all the brine shrimps. When the brine shrimps and algae die, their remains rot and decompose and atoms (of the elements) and molecules (of different sorts) are re-cycled in the bottle. These go back to help the algae to grow again.

Environmental scientists call the components of the global ecosystem the **Lithosphere**, the **Hydrosphere**, the **Atmosphere** and the **Biosphere**. In the same way your bottle has minerals, water, air and a living community. Your bottle ecosystem is a small 'world' in itself.

The Challenge

Make a bottle ecosystem of your own and keep it in a sunny place. Watch the life in your brine shrimp bottle. Keep a record of what happens. Will your bottle ecosystem behave in the same way as another bottle ecosystem? This is your chance to find out.

Apparatus that you need

You will need the following:

- a clear clean plastic bottle between 1 and 3 litres
- some sand and shell for the mineral substrate
- some salt water (de-chlorinated water + sea salt)
- a source of the microbial system from the tank bottom
- some brine shrimps
- mineral fertiliser solution with dropper
- large measuring cylinder
- balance
- dessert spoon
- plastic funnel for putting sand and shell into bottles.

Procedure 1... setting up the bottle ecosystems

1. Choose a large bottle with clear sides that is easy to see through. If there is a label you wish to remove, put some hot water (50° C) in the bottle and you will find that the label will peel off easily.

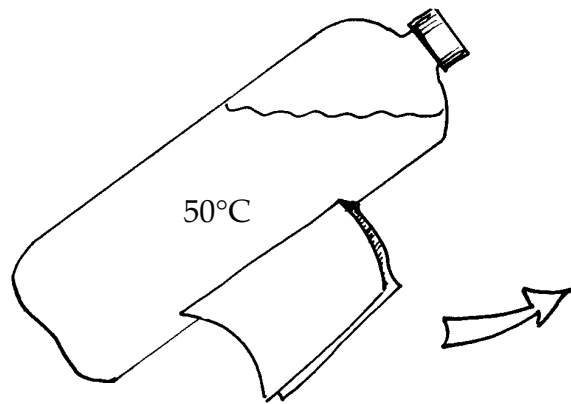

2. Fill the bottle completely with tap water. Pour off water so that one fifth of the bottle is air. This will be your bottle's atmosphere. Mark this level with spirit marker. Find the remaining volume of water by pouring it out into a measuring cylinder: e.g. in a 1.5 litre bottle you might have left 1.2 litres of water and 0.3 litres of air.

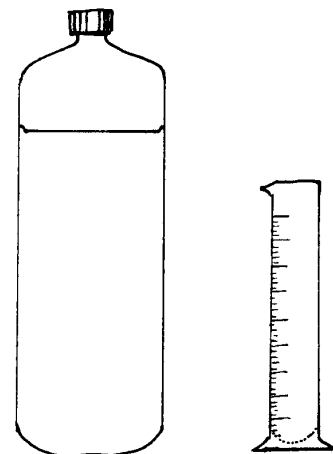

Bottle and measuring cylinder

3. Add sand and crushed limestone or sea-shell to the bottom of the bottle to a depth of 2 - 3 cm. This will provide a mineral substrate.

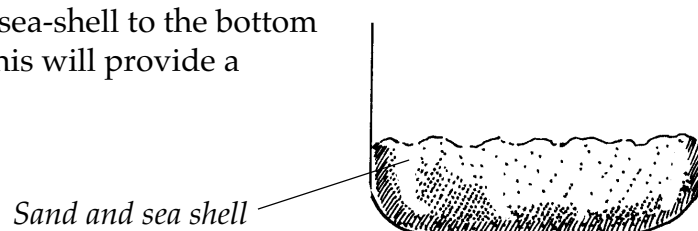

- Next you should add two drops **per litre** of the mineral fertiliser solution. *Baby Bio* is suitable.

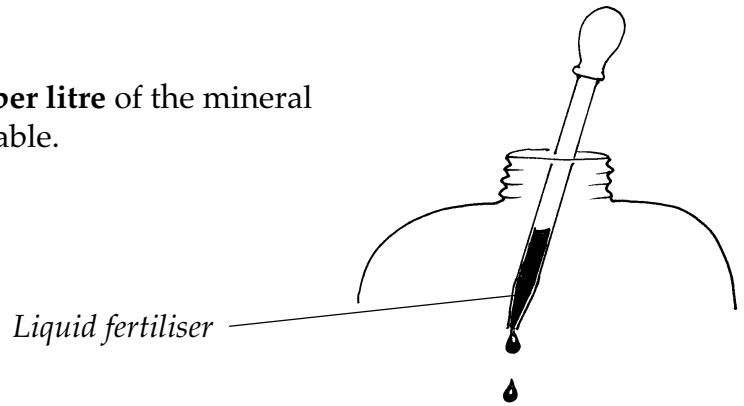

- Then do a calculation and a weighing. Multiply the volume in litres of the water that you want for the bottle by 30. (e.g. 1.2 litres x 30 g = 36 g) Weigh out this mass of sea salt. Add it to your bottle.

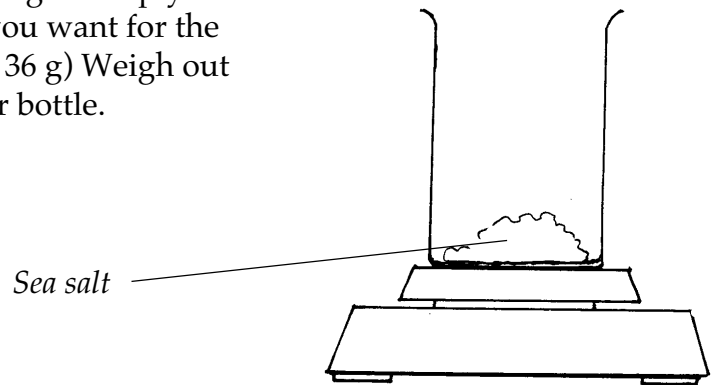

- Next you need two large dessert spoonfuls of the sand and shell from the bottom of the old tank. This contains the ecosystem's microbial community.

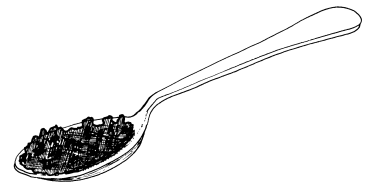

- Now add the right volume of de-chlorinated water to the bottle up to the mark*. Screw on the lid. *Shake the bottle hard* for half a minute! Now you have a salt water environment.

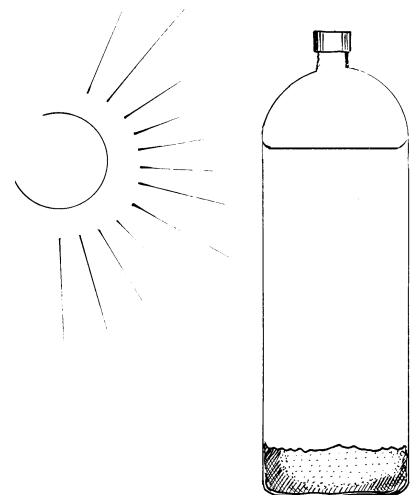

- Now your bottle ecosystem is ready for its algae to grow. Place it in a sunny place, like a south facing window, or near to a light if it is winter time.

* N.B. Tap water is treated with chlorine to kill harmful micro-organisms. This chlorine may also harm the brine shrimps so it is important to leave tap water to stand in a bowl open to the air for at least 48 hours to allow the chlorine to escape. This is what is meant by de-chlorinated tap water.

Procedure 2...the ecosystem is colonised by brine shrimps

1. After a few days look inside your bottle and see if there is any sign of green life! Give the bottle a shake and leave it open to the air. If you can see any greening of the water, then your ecosystem is ready for the shrimp invasion.
2. It is suggested that you add about 15 shrimps of different ages to the bottle. Record what you add.
3. If no green colour is observed, place the bottle back in a light position and leave a little longer.

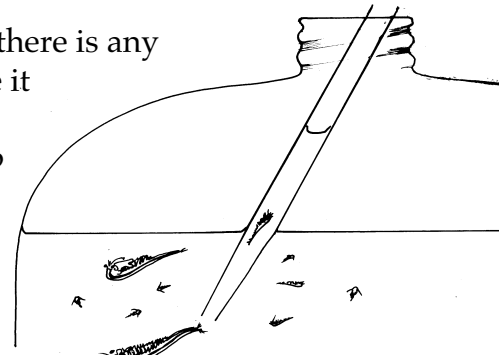

Procedure 3...bottle ecosystem management

1. Now take your bottle home and set it in a sunny place or by a lamp. You are now ready to begin your shrimp bottle diary (see below).
2. Add no more than one drop of liquid fertiliser per litre of salt water per week. Once the full population has developed the addition of fertiliser should be reduced. Keep the cap off the bottle or, at most, lightly screwed on. Why is this ?
3. Once a week screw on the cap firmly and roll the bottle gently on its side. This helps mineral nutrient cycling and keeps the sides of the bottle clear of algae to allow in the light.

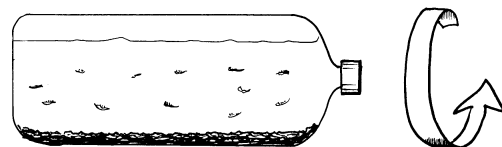
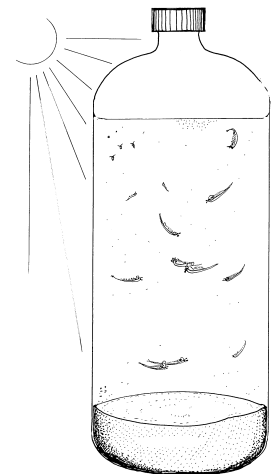

Brine shrimp bottle diary

Day & date	The environment-report on algae and water events	Numbers of brine shrimps today	Hatching, growth and death of shrimps	Adult sex ratio, courtship behaviour and reproduction events
<i>Mon April 3rd</i>	<i>The bottle water was pale green.</i>	<i>8 nauplii and 8 adults.</i>	<i>8 very young shrimps were put in with 4 adult males and 4 adult females.</i>	<i>2 males have paired up with 2 females.</i>
<i>Tues April 4th</i>				

7: EXPLODING POPULATIONS

The Challenge



What happens if we put a male and a female brine shrimp in a container with food and adequate heating and lighting?
 Would their numbers rise?

It would probably depend on how long we left them in the container but suppose we let the experiment run for a month, or a term - what will happen?

Does the amount of food the shrimps have during this period matter?

In this experiment you will set up a number of containers and monitor what happens in each one on a weekly basis.

How does the population of brine shrimps in a container change over time and what is the influence of the feeding regime?

You might wish to put forward a **hypothesis** which you could test.



For example, one study found that females can produce about 100 eggs (which take about three days to hatch) in each brood and can produce a brood every 4-5 days, once they reach sexual maturity, at about 3-4 weeks old. So you might think that by the end of week 2 (i.e. two weeks after the sexually mature pair were put into the container) you would have about 200 newly hatched shrimps, plus the original male and female.

Apparatus that you need

To set up this experiment you need the following items of equipment:

- nine plastic bottles (330 cm³ are fine)
- salt water (a concentration of 30-35 g per litre - this needs to be made up first)
- a plastic teat pipette, or dessert spoon, or sieve, to catch your shrimps from the holding tank
- nine gummed labels to identify each bottle
- substrate from the main brine shrimp tank
- bench lamps - to provide a source of heating and lighting for the shrimps during the month, or term, that the experiment is running
- liquid fertiliser and *Liquizell*.

Procedure

1. Put 250 cm³ of salt water into each bottle and then add two dessert spoonfuls of substrate from the main tank and one drop of fertiliser. This will add algae and provide some food for the shrimps.
2. Using the teat pipette, or the dessert spoon, or sieve, catch one female and one male from the main holding tank and put them into one of the bottles and label this bottle A. Then repeat with the other eight bottles, labelling them B, C, D, E, F, G, H and I.
3. Put bottles A, B and C in a location where there will be adequate heating and lighting whilst the experiment is running and add to the label on each bottle 'control'. Bottles D, E and F can also be put in the same place, but add to the label on each bottle '1 drop per week'. Bottles G, H and I have the words '3 drops per week' written on each label and then the bottles can be put alongside the others. Add the appropriate number of drops of *Liquizell* each week whilst the experiment runs.
4. All being well, a few days later you will see the first eggs that the female has laid. These will be tiny brown grains, a little bit larger than pepper grains, and will probably be floating on the surface at the side of the bottle. When you first see the eggs or nauplii, add the stated number of drops of *Liquizell* only to the bottle as appropriate; record the date.
5. At the time you set up the bottles, the population in each bottle will be two. [If one, or both, adults die before eggs are laid then replace the dead adult with another of the same sex]. Record the number of brine shrimps in each bottle and keep the records safe. At the start, the counting should not be too difficult but as the experiment goes on it may be best to empty the contents of the bottle into a larger container, like a beaker, whilst you count the shrimps in each bottle. Transfer them back into their 'home' bottle safely after counting them.

Results

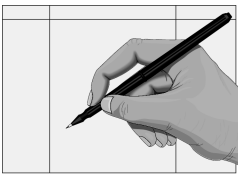

Record your results in a table, keeping the data from the three different feeding conditions separate. Then draw a graph of the data in the best way you can; a line graph might be a good choice. You might find the average population size for each of the three conditions over time and on a separate piece of graph paper plot these data also.

How does the population in each bottle change over time?

How does the average population for each of the three feeding conditions change over time?

Has the *Liquizell* had an effect on the population sizes in the bottles?

Has your hypothesis been confirmed?

Questions

1. Have your bottle populations behaved as your main brine shrimp holding tank has whilst the experiment is running. If not, why?
2. Has the population in your brine shrimp bottle behaved in the same way as another person's population?
3. Has the sex ratio of adults in the bottle remained 50:50 whilst the experiment has been running?

8: PREDATORY SHRIMPING

The Challenge

Are you ready to be a predator? What effect does predation have on a tank of shrimps?

Will the predator really reduce the population a lot or will the predator just keep the numbers down a little?

One of the commonest predators of brine shrimps is the Greater Flamingo. These are wonderful birds with a great big beak. (When its head is up it looks rather a grumpy bird, but when its head is down it seems to smile at us!). The flamingo feeds with its head in the salt lake. It sweeps its head from side to side and walks slowly forwards as it goes. In its beak are little hooks and spikes which seem to catch the brine shrimps. It has a big tongue that sucks up the water like a syringe and then squirts it out again after it has been through the filter, see page 31.

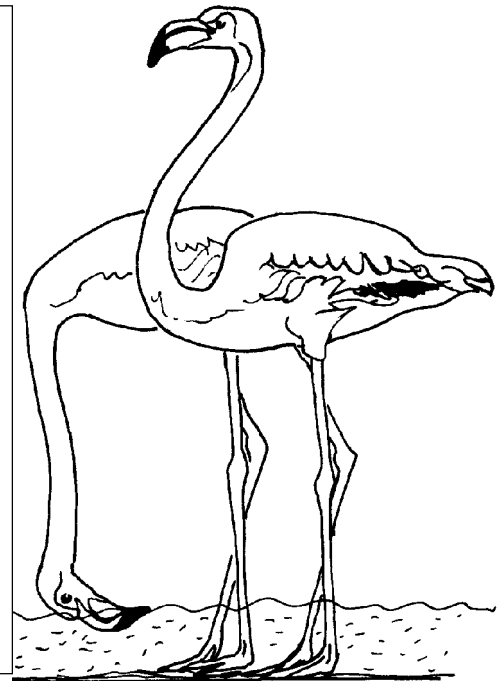

Apparatus that you need

You are going to carry out an experiment to see what effect filter feeding has on a population of shrimps. To make this a fair test we shall divide the whole brine shrimp population under investigation into two halves. One half will have no predator (the control group) and the other half will have YOU playing the role of a flamingo! As you don't have the right kind of beak we shall give you a **tea strainer** instead!

To set up this experiment you need the following items of equipment:

- two equal size and roughly equal population tanks of brine shrimps
- a tea strainer
- a 400 cm³ beaker
- a third tank **OR** an aquarium with a fish in it
- four 250 cm³ beakers for sampling the tank populations.

Procedure

1. Your whole class needs to have a discussion first about what will happen to the predated shrimps. One tank will have shrimps captured by you and the other one will not. The shrimps that you catch must not go back **either** into the same tank **or** into the control tank. You **either** need a third tank to put them into **or** you could realistically feed them to, say, a goldfish in a further tank.
2. You will have two tanks, one for predation and one as a control.
3. Decide on a rota for being the predator. Everyone will be given a 'flamingo day'. You will need to know the standard 'fishing' practice. One sweep through the tank is enough.

4. When it is your turn to be the predator, sweep the sieve through the water **once only each day**. Fill a large beaker with de-chlorinated salt water and put the brine shrimps into this from the sieve. Count them and record the number of brine shrimps.



5. Immediately pour the water through the sieve again and re-collect the shrimps. Either, rinse the brine shrimps with fresh water and then feed the brine shrimps to the fish, or, release them in the third tank. Disposal of brine shrimps when they are not needed is an issue which needs to be considered.

6. Your second task on your 'flamingo day' is to do a sample count of the shrimp population. Gently stir one tank and then dip in four 250 cm³ beakers and count the number of shrimps in each of them. Record the numbers in the table. **You must pour the shrimps back into the same tank.**

7. Stir the second tank. Repeat this procedure (above) with four more beaker samples. Record the numbers each time. **Pour the shrimps back into the same tank.**

Class Recording Table

Date	Number of shrimps caught today by the flamingo	Numbers of shrimps in each of four beakers sampled from the flamingo predator tank . Total equals shrimps per litre	Numbers of shrimps in each of four beakers sampled from the control tank with no predator . Total equals shrimps per litre
		+ + + =	+ + + =
		+ + + =	+ + + =
		+ + + =	+ + + =
		+ + + =	+ + + =

Questions

- At the end of this experiment was the flamingo catching the same number or fewer shrimps? Explain why the number is what you have found out.
- Add together the numbers of brine shrimps in the beakers for each tank for each day. This will be a total number per litre. Then make a graph to show how the population in the two tanks has changed.
- Calculate the total number of shrimps in each tank **at the end of the experiment**. You could make this more accurate by finding the average number per litre on the last three days.

NB: tank volume in litres =

$$\frac{\text{Length in cm} \times \text{Breadth in cm} \times \text{Depth of water in cm}}{1000}$$

Shrimps per tank = shrimps per litre x litres per tank

What is your answer?

4. Compare the difference between the numbers in the two tanks at the end of your experiment and the number of shrimps 'eaten' by the flamingo. What do you learn from this experiment?
5. The picture below is of the filters on the inside of the beak of a greater flamingo. The picture on the right hand side is **magnified ten times**.
 - (a) Measure in millimetres the distance between the big outer hooks of the beak in the right hand picture. Using the scale on this picture, calculate the real distance in millimetres between the big hooks.
 - (b) Measure the distance between the small inner spikes, in the diagonal rows. Calculate the real distance between the little spikes.

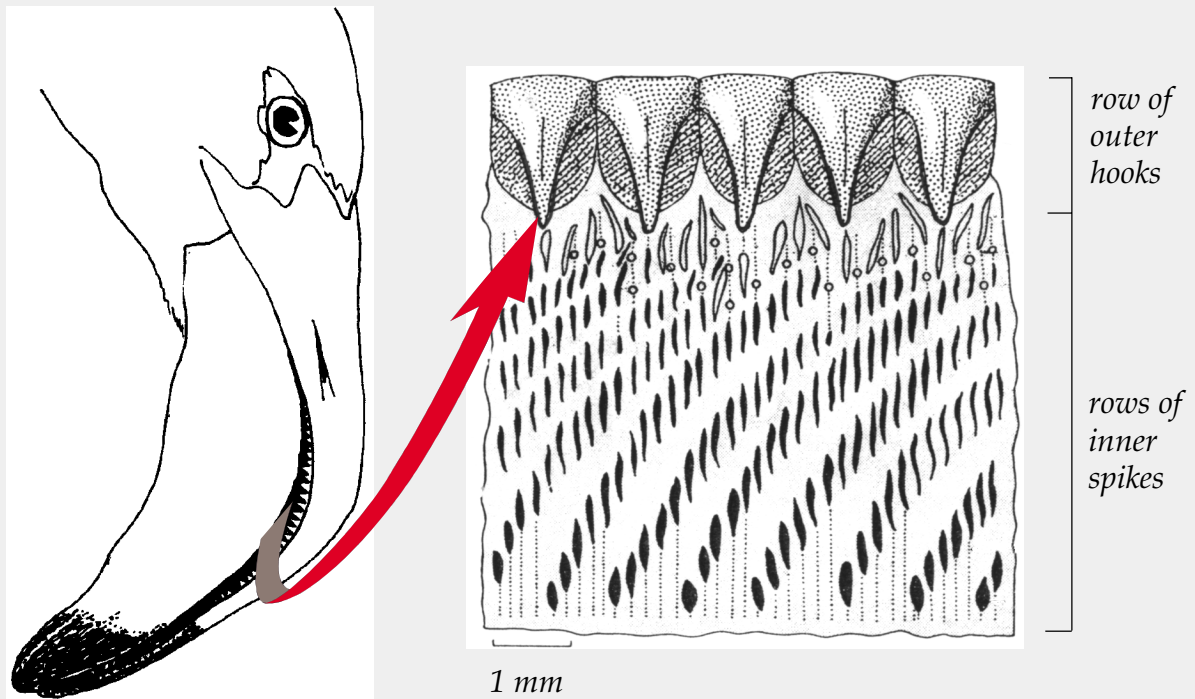

This investigation was done by Penelope Jenkin, who, as a young biologist, went on an expedition to the salt lakes of Kenya, Africa, in 1929. She was the first person to discover exactly how flamingoes feed and precisely what it was that flamingoes eat. Brine shrimps are often the greater flamingo's main food.

6. How big is an adult brine shrimp? How big is a nauplius?
7. Make a hypothesis to suggest why the flamingo has two sizes of sieve.
8. How would altering your sieve size affect this experiment?
9. Why are Governments always arguing with fishermen about the mesh size of their nets?

9: ARE SHRIMPS VERTICAL COMMUTERS?

Background

You will have noticed that in an aquarium or a bottle the shrimps swim around and change their position up and down. Sometimes they are at the bottom, sometimes near the surface. This behaviour may be linked to where they find their food, what age they are and even what sex they are. You may have seen the shrimps feeding on the algae at the bottom of the tank. If they are very busy feeding they could spend a couple of minutes there. But over a longer period of time, do individuals stay more or less in the same part of the tank or do they swim frequently up and down?

Every day large numbers of people travel into large towns and cities in the morning and return in the evening. These people are called commuters. Why do they do it?

In this practical you can find out if the brine shrimps are also commuters going to and staying in one area or if they simply move around with no apparent pattern. For this experiment you can divide the column of water in a bottle horizontally into three zones: the top third, the middle third and the lower third.

The Challenge

Do brine shrimps commute vertically in a container?

What would be a suitable hypothesis to test in this experiment?

Apparatus that you need

To carry out this experiment you need the following items of equipment:

- a plastic bottle (or beaker) - a clean soda or cola bottle will be perfect for this, if unavailable a beaker will be fine
- two elastic bands
- three brine shrimps - one male, one female and a young shrimp
- salt water
- a dessert spoon or sieve
- substrate from the main brine shrimp tank
- a plastic teat pipette (or the dessert spoon), to catch your shrimps from the tank
- a stop watch, or stop clock
- a 30 cm ruler
- a small glass beaker, 100 cm³ or 200 cm³.

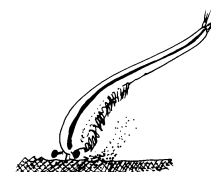
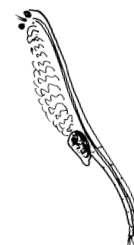

Procedure

1. Fill the bottle about three-quarters full with salt water and then add two dessert spoonfuls of substrate from the main tank. Leave this to settle for a few minutes.
2. Take the small beaker to the main tank and put some salt water into it, about one third full will be adequate. Then with the teat pipette, sieve or spoon, collect an adult male, an adult female and a young shrimp from the tank and put them carefully into the small beaker.
3. With the ruler, measure the vertical height from the surface of the bottom to the top of the water column. Divide this height into three. Mark on the outside of the bottle, with a marker pen, the one third and two third distance up from the bottom. Put elastic bands around the bottle to show the three sections. Make sure the elastic bands are horizontal (level).
4. Put one adult female in the bottle and give her five minutes to get used to her new surroundings. Then, using the stop watch, record which zone of water she is in every 10 seconds for a period of ten minutes and how many times she changed zones in those ten minutes. This will mean that you will have 60 pieces of information for this animal.

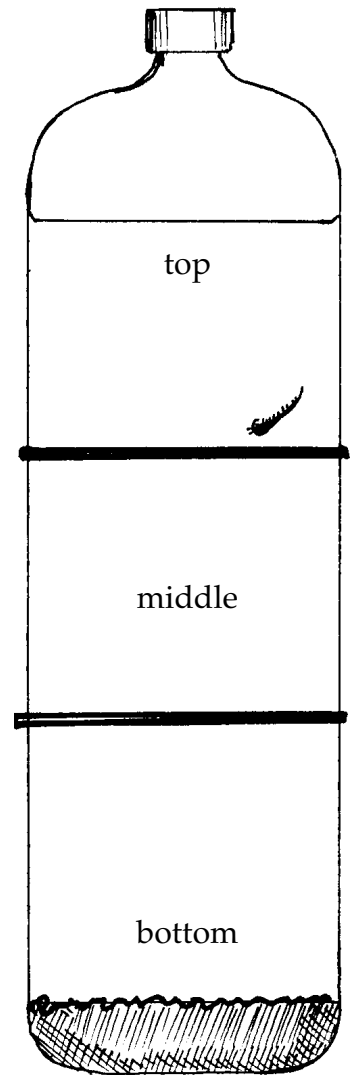

Shrimp	Position in the water column			
	top zone	middle zone	bottom zone	changed zone
Female Brine shrimp				

5. Repeat this procedure with the male shrimp and then a very young shrimp, about one half the length of an adult.

Results

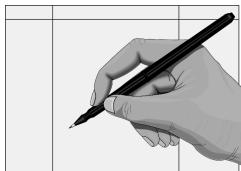

A compound bar graph, or pie charts, might be a particularly useful way to present the data. It would also be worth determining the approximate total time that the female, the male and the young shrimp spent in each of the three sections of the bottle.

If this study is replicated by other groups in your class compare your results with the class data for the females, the males and the young brine shrimps. The data from the whole class will be more representative.

Does there appear to be a difference between the three shrimps? Do brine shrimps commute across the three bands or do they tend to stay within one area of the bottle, at least for the time period used in the study?

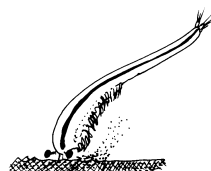

Questions

1. What improvements or changes to the experimental set up would you make if you were to repeat this investigation?
2. Might the presence of other shrimps in the bottle affect the degree or pattern of commuting?
3. Why might brine shrimps move up and down in the water in a salt lake in the wild?
4. Does their commuting pattern vary over a twenty four hour period. How might you find out what happens at night or in the dark?

10: SPEEDY SHRIMPS - fleeing and finding a mate

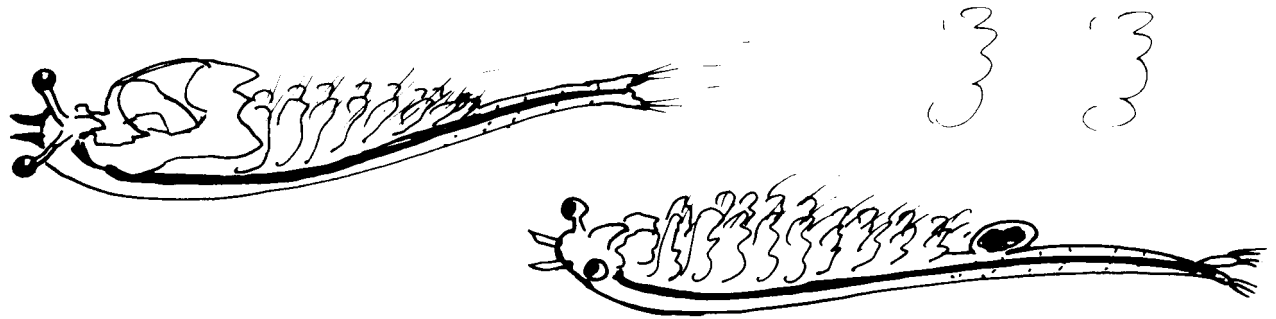

Background

Have you noticed how shrimps in your bottle can suddenly move quickly, especially after you tap the bottle or if a sudden shadow appears. This is called an **escape response**. Can you suggest two reasons why it would be useful for a shrimp to be able to swim quickly? Have you noticed any differences in the speed of males and females and young shrimps?

Is a 12 or 15 year old human as fast as an adult runner? Why are men adapted to run faster than women? Is this anything to do with their ancient biological roles as males and females?

How fast can a shrimp swim? Is there a difference between shrimps of different ages or between males and females? Is there any biological reason why their speeds might differ?

The Challenge

How fast can different shrimps swim? The challenge is to carry out a fair test experiment to see just how fast a shrimp takes to swim, say, ten centimetres.

Apparatus that you need

The class will be divided into groups and each group needs the following pieces of apparatus:

- a stop watch, or stop clock
- a piece of glass or plastic tubing, with bungs
- some salt water (this can be taken from the brine shrimp tank)
- a sheet of graph paper and a piece of Blu-Tack
- a plastic teat pipette (this should have been made big enough to allow a shrimp through but do take great care when catching the shrimps; they have very delicate legs and if their legs are damaged this will affect how fast they can swim), or a sieve
- three shrimps, which can be taken from the tank one at a time when you are ready to use them. After you have used a shrimp put it in the holding tank or bottle until the experiment is over. Each team should use:
 - a) an adult male shrimp
 - b) an adult female shrimp
 - c) a young shrimp.



Procedure

1. Close one end of the tube with a bung and carefully fill it with salt water.
2. Using the pipette, carefully capture an adult male shrimp from the tank and introduce it into the tube. Put the cap on the other end of the tube. [When you do this you will almost certainly get a bubble of air inside the tube. This will not matter, providing it is not too big.]
3. In the centre of the sheet of graph paper mark out a scale from 0-10 cm. Put two small bits of Blu-Tack on the other side of the piece of graph paper and stick it down on a smooth, flat part of the table/desk/lab. bench.
4. Place the tube, with the shrimp inside, over the graph paper so that the 0-10 cm scale is beside the tube so that you can see it easily. Keep the tube in this position when you make all your observations.
5. With a stop watch, time how long it takes for the shrimp to swim 10 centimetres and write down the time on the recording sheet. Try to record the time to the nearest tenth of a second; if this is not possible, record the time to the nearest second.
6. Repeat this four times, so you should have five numbers altogether.
7. Using the millimetre lines on the graph paper, measure the length of the shrimp to the nearest millimetre and then return it to the holding tank.
8. Repeat this for the adult female shrimp and the young shrimp, recording these results in the same way.



Results

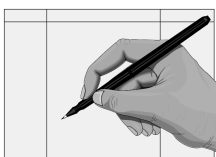

Time in seconds to swim 10 cm	Adult male brine shrimp	Adult female brine shrimp	Young shrimp
1			
2			
3			
4			
5			
Total			
* Average			

* Calculate the average time it takes for each shrimp to swim ten centimetres.

Questions

1. What are your conclusions? Do other groups agree with you?
2. Make hypotheses to explain any differences in speed and energy expenditure between the sexes.
3. What result would you expect to get from a 'tandem-pair' of shrimps swimming together? If you have time, test this prediction.

11: ALTERING THE BALANCE - pollution studies

Background

In the wild, brine shrimps live in salt lakes. These salt lakes are often in isolated areas and there are very few humans living there. The influence of humans on these aquatic environments is, therefore, very slight. In aquatic ecosystems in Britain, however, the actions of people sometimes affect the organisms that live in lakes and ponds. One way in which humans affect lakes and pools is by polluting them.

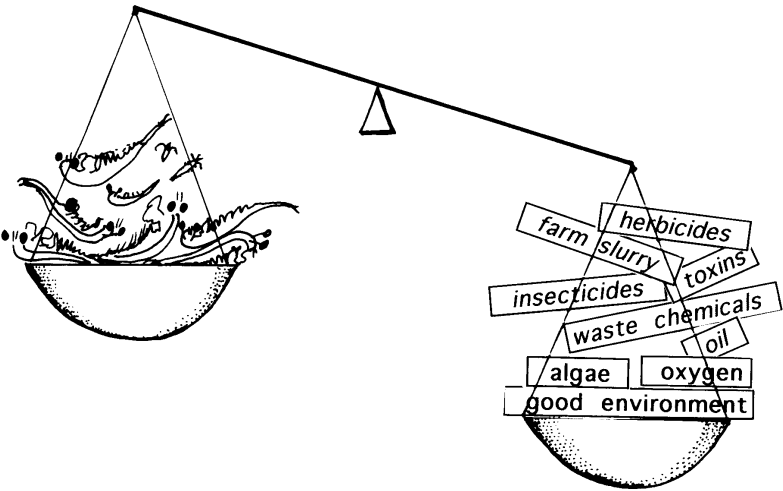

A pollutant is a substance which, in sufficient quantities, upsets the balance of an ecosystem and causes harm to the organisms within it. One pollutant that could enter a pond or lake in Britain is a garden herbicide, such as *Simazine*. This might occur after a period of heavy rain when water runs over and through the soil, taking the herbicide with it and carrying it into streams which flow into lakes and rivers. [Herbicides are chemical substances used by gardeners to get rid of weeds.] If *Simazine* gets into a lake or pond in a small concentration it kills the algae, because they are plants but, at the concentrations recommended here, will not harm the brine shrimps. But is there a more round about way in which *Simazine* might affect the growth of brine shrimps?

The Challenge

In this investigation you can determine if adding the herbicide *Simazine* to a brine shrimp ecosystem affects the brine shrimps. This investigation focuses on whether the weedkiller affects their rate of growth. In particular, it considers whether adding a herbicide, such as *Simazine*, to the salt water affects the growth rate of algae and of the brine shrimps over a week.

What would be a suitable hypothesis to test in your experiment?

Apparatus that you need

- To carry out your study you need the following items of equipment:
- adhesive labels
 - a stirrer and a dessert spoon
 - 20 juvenile brine shrimps
 - a dropping bottle containing 0.1% *Simazine* solution
 - 1000 cm³ salt water (a concentration of 30-35 g per litre - this needs to be made up first)
 - a teat pipette, to catch your juvenile brine shrimps from the main brine shrimp tank
 - four 250 cm³ beakers
 - substrate from the main tank
 - fine cloth and filter funnel.

Procedure

1. Add two dessert spoons of substrate from the main tank to the litre of salt water. Stir it up well and pour the water through a fine cloth filter. Then pour one quarter of the filtered water (which will now have some few microscopic algae in it) into each of four beakers (250 cm³ into each).
2. Place the beakers in a well-lit and warm place in the lab (such as a south-facing window sill) and leave them for a week. This allows the algae in the beakers to build up their population nicely before the brine shrimps are added.
3. A week later stir the beakers and look for evidence of algal growth. Label the beakers 'Control 1', 'Control 2', 'Simazine 1' and 'Simazine 2'.

Add 5 drops of *Simazine herbicide* to each 'Simazine' labelled beaker and stir up the contents of both. Wash the stirrer under tapwater and dry it off. Then stir up the contents of the two other beakers in a similar way.

4. Then, using the teat pipette, catch twenty (half grown) juvenile brine shrimps from the main tank, putting ten into the beaker labelled 'Control 2' and ten into the beaker labelled 'Simazine 2'.
5. Return the beakers to the same well-lit, warm position as before and leave them there for a week.
6. At the end of this second week, compare the green colour in the four beakers.



Count, and record, the number of shrimps that are still juvenile size and the number that are adult size in each of the shrimp containing beakers. Then return the shrimps to the main tank where they can enjoy a normal food supply.

Results

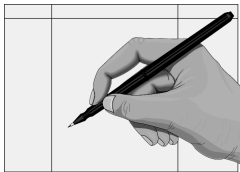

Record your results in a table, and if the experimental set up has been replicated by other groups, add their data to your table. It is also worthwhile calculating the percentage of animals in each size class (the two size classes being 'juvenile' and 'adult') in each beaker, at the end of the second week.

You may wish to plot the class size data as pie charts (divided circles).

Questions

1. Has the *Simazine* had an effect on the growth rate of the algae? (see 'Control 1' and 'Simazine 1') Has your hypothesis been verified?
2. Has the *Simazine* had an effect on the growth rate of the shrimps in one of the two shrimp beakers? (see 'Control 2' and 'Simazine 2'). Has your hypothesis been verified?
3. What improvements or changes to the experimental set up would you make if you were to repeat this investigation?
4. Was a week long enough for this experiment to run?
5. Suppose that you had added a fertiliser, such as *Baby Bio*, to the salt water instead of a herbicide. What would the result have been?

12: THE SUN-SEEKERS - let there be light!

Background

When the brine shrimps are in the main holding tank you must have noticed that they respond to the light. Sunlight is important for photosynthesis and brine shrimps too seem to notice the light intensity, its direction and even its colour. Their response to light may be an important part of their adaptation for finding their food (photosynthetic algae).



The Challenge

What happens to brine shrimp swimming behaviour if you alter the brightness or direction of the source of light to the tank? What happens if you offer brine shrimps the choice of swimming in water lit by lights of two different colours? These are some of the situations you can study here.

- A Do shrimps distribute themselves evenly when swimming in an unevenly lit container? Are they sun-seekers?
- B What happens to the 'normal' swimming position of the shrimps if the light source is from below rather than from above?
- C How do the brine shrimps respond if offered the choice of a different colour of light? Do shrimps prefer, say, red or green light?

What would be suitable hypotheses to test in each of these cases?

Apparatus that you need

To carry out this series of experiments you need the following items of equipment:

- an overhead projector
- a dessert spoon (or wide-mouth pipette or sieve) to catch shrimps from the main tank
- 12-20 adult shrimps (the sex of the shrimps is probably not crucial, though you may think it is a good idea to have roughly equal numbers of each sex)
- a stop watch, or stop clock
- a sheet of acetate
- an overhead projector pen, preferably black

- a ruler
- at least two different colours of cellophane (or colour gels) - each of the two, or more, sheets needs to be about half the size of the glass top of the overhead projector
- a sheet of black card, or black paper, again about half the size of the glass OHP top
- a pair of scissors
- a circular or rectangular glass tank - the tank should be of a size that fits inside the glass top of the overhead projector
- salt water (enough to fill the glass tank to a depth of 20-30 mm)
- a 200 cm³ glass beaker
- a bench lamp
- a thermometer to check on the water temperature (32° C is too hot!).



During the course of a normal lesson, say up to 1½ hours, the rise in temperature of the salt water in the dish should not have any harmful effect on the shrimps.



In these experiments a glass dish with salt water in will be placed on the overhead projector. It is most important that the OHP should not be knocked or disturbed and cause the water to spill out of the dish. If this should happen **inform your teacher at once**. It could be dangerous to touch the OHP if any water gets inside it. Your teacher will give you further advice about safety.

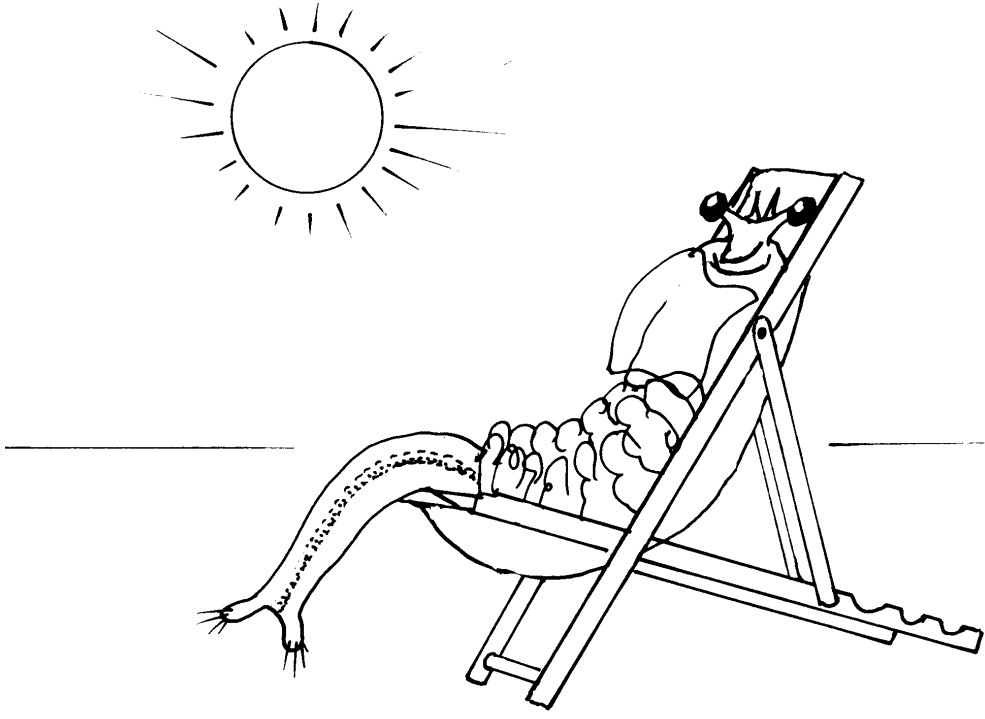

EXPERIMENT A

Are the shrimps distributed evenly in the dish?

Procedure

1. With the overhead projector pen, draw a big cross in the centre of an acetate sheet as follows: draw a horizontal line across the middle of the sheet, mark the centre of this line and then draw a vertical line at right angles to it. Put the sheet on the overhead projector just to check that the cross is clearly visible on the screen.
2. Put salt water, to a depth of 20-30 mm, into the circular dish or the rectangular tank. From the main holding tank collect 12-20 adult brine shrimps, using the dessert spoon or pipette, and put them carefully into the dish.
3. Centre the dish over the acetate cross and adjust the focus on the overhead projector to project a clear image on the screen. You will see that the circular image of the dish has been divided into four equal areas by drawing the cross. Leave the brine shrimps to settle for a couple of minutes.
4. Then start the stop watch and record the number of shrimps in each quadrant at every 15 second interval over a period of five minutes. This will give you 20 recordings. [If you are doing this as a class activity you will be able to have a number of recording groups for each quadrant: this is useful as noting the number of brine shrimps in each quadrant is not easy and so the number of shrimps in each quadrant can be checked.]
5. Repeat this experiment but cover two of the areas with a black piece of paper or card under the tank so that two are 'dark' and two are 'lit'.

Results

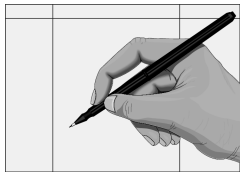

Put your results in a table and then choose an appropriate graphical technique to represent the data.

Are the numbers of shrimps in each half roughly the same? Calculate the average number of shrimps in each half and compare the averages. If they are not the same, consider what factor, or factors, may be influencing the distribution of the shrimps. It may be the daylight from the windows in the room, or perhaps some feature of the dish.

Did darkening half of the dish make a difference?

Why is it an advantage to a shrimp to be a sun-seeker?



IMPORTANT: The brine shrimps should not be left in the dish for longer than necessary, check that the temperature does not go over 30° C. Remember that there is no food available in the dish so you must put the shrimps back into the main holding tank as soon as you have finished the set of experiments.

EXPERIMENT B

Does the swimming position of a brine shrimp change if the light is from below the dish, rather than from above?

Procedure

1. Take the dish with the shrimps from the overhead projector and place it carefully on the bench surface. Use a lamp to shine the light down from above. Look at the shrimps swimming in open water. Record the number that are using the 'normal' backstroke swimming position. Record the numbers of any that are the other way up.
2. Now place the dish again back in the centre of the overhead projector. Leave the brine shrimps to settle for a minute. Then look at the shrimps carefully and record the number in the 'normal' backstroke swimming position and any the other way up.

Results

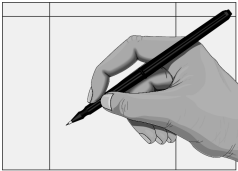

Put your data in a table and then, choosing an appropriate graphical technique, represent the data.

Are the shrimps consistent in their choice of swimming position? If they use different swimming positions depending on the source of the light, why should this be so? How might the shrimps detect whether the light source is from above or below? Why would it be important for shrimps in the wild to detect the source of the strongest light?



IMPORTANT: *The brine shrimps should not be left in the dish for longer than necessary, check that the temperature does not go over 30° C. Remember that there is no food available in the dish so you must put the shrimps back into the main holding tank as soon as you have finished the set of experiments.*

EXPERIMENT C

Do brine shrimps show a preference for staying in that half of the dish illuminated by, say, red light rather than green?

Procedure

1. Remove the dish with the shrimps from the projector and place it carefully on the surface of the bench.
2. Take two (say red and green) of the sheets of cellophane, or colour gels, and place them on the sheet of acetate so that each is lying on one side of the vertical line of the cross. If you now look at the screen you will see that half of the screen is green, the other half is red.
3. Put the dish with the shrimps back on the projector, ensuring that the centre of the dish is on the centre of the cross on the acetate. Leave the brine shrimps to settle for a minute.
4. Then start the stop watch and record the number of shrimps in each quadrant at every 15 second interval over a period of five minutes. This will give you 20 recordings.

Results

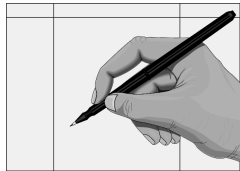

Put your results in a table and then, choosing an appropriate graphical technique, represent the data.

Are the number of shrimps in each of the two areas of the red half, and the green half, the same? Are the number of shrimps in the red and green halves the same? If they are not the same, which colour have the shrimps shown a preference for?

Try replacing one of the colours with another that is available and then repeat the experiment. Do the brine shrimps seem to show a preference for one colour rather than any of the others?

Why should the colour of the light make a difference?



IMPORTANT: *The brine shrimps should not be left in the dish for longer than necessary, check that the temperature does not go over 30°C. Remember that there is no food available in the dish so you must put the shrimps back into the main holding tank as soon as you have finished the set of experiments.*

13: NOW GO PONDING - investigating the biology of 'water-fleas'

The Challenge

Now you know all about brine shrimps you may want to go and investigate the Crustacea in your own environment.

The challenge is now to go and apply some of your knowledge of the ecology of brine shrimps to a species nearer home.

Background

Water-fleas are one of the most common groups of Crustacea in Britain's own ponds, lakes and streams. Sometimes they are so abundant that the water is full of them. There may be a population of dozens in a litre of pond water and millions in one pond alone during the summer.

In this investigation you are sure to find some water-fleas and your experience with brine shrimps will ensure that you will now be asking the right kind of **scientific questions** about their ecology.

Water-fleas are of course not real fleas. Real fleas are insects that suck blood and hop, sometimes from one host to another. Water-fleas are Crustacea, and are, therefore, related to brine shrimps. They do 'hop', though with a jerky upwards motion, as they swim in the water. The smallest brine shrimp nauplii swim with their second antennae soon after they hatch. This is what the water-fleas continue to do as a way of swimming all through life. Their second antennae are huge and pull them up in the water with jerky rowing movements. At each little jump the animal seems to fall back to where it was before. Unlike a brine shrimp, the whole body of a water flea is enclosed in a folded horny shell (the **carapace**) that goes over its back. Only the head and antennae stick out, most other parts are tucked inside.

Like the brine shrimps they feed on algae, passing the particles up to their mouths with the little bristles on their legs. Like brine shrimps they also produce offspring from a brood-pouch. This is hidden under the back fold of the horny shell carapace.

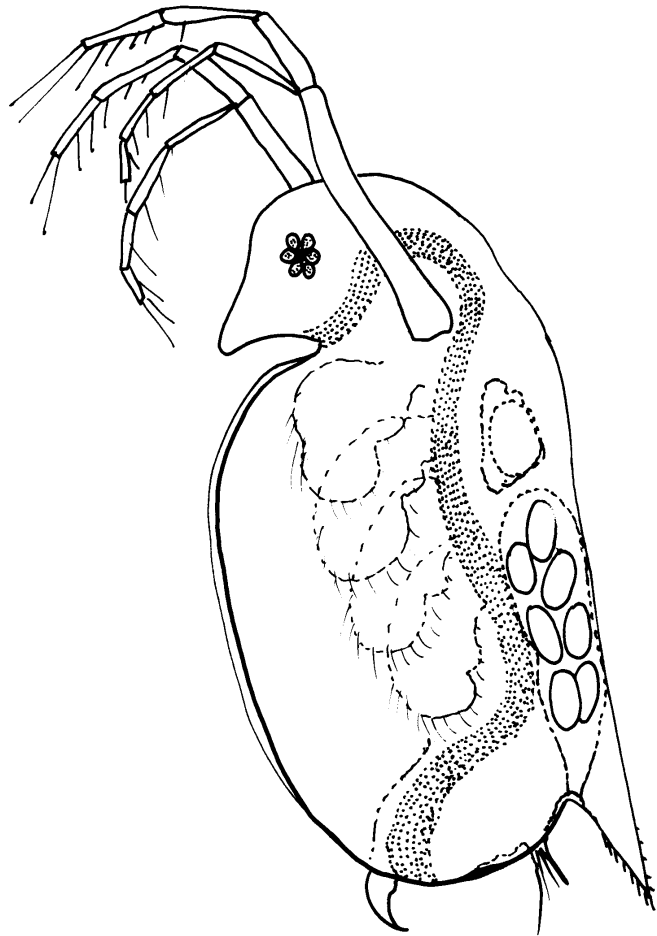

Here the water-fleas hatch out from their eggs under the mother's protection so that they even begin to feed in there before they come out and live independently. Water-fleas make the best of the good summer weather by producing offspring without bothering to mate. This virgin birth or **parthenogenesis** is common in Crustacea (there are even some parthenogenetic brine shrimps in China). Only when the winter approaches and the algal resources decline do we find that female water-fleas start to produce eggs that become males. These males mate with sexual females and only

then are their offspring produced as fertilised eggs. These will be dormant in the mud all through the long dark winter. Water-fleas are often not hatched until April. The best time to find them is in the summer in a pond or ditch where there are few if any fish. You might easily do a water flea study through the summer.

When you go ponding with a plankton net you may first see the water-fleas as a cloud of little brown jerky speckles in the water.

Sometimes the water is red-brown in colour there are so many. The red colour is due to the fact that they produce haemoglobin. This is similar to the red pigment in our blood that carries oxygen. When you have been ponding remember to bring back only as many specimens of the animals for study as you need. The rest should go back to their home environment after you have looked at them.



When working in such freshwater environments always wash your hands in soapy water afterwards and whenever possible wear plastic gloves. Remember that ponds can be dangerous places.

Apparatus that you need

To go ponding you need:

- a plankton net
- some white trays into which you may put what you catch from the net
- a screw top jar for bringing back samples to the lab
- a notebook, to write down your observations
- a set of pictures, or keys, of pond animals for identifying species.

Procedure for using a plankton net

1. **Take great care not to fall in when ponding!**
2. Study the diagram of the fine nylon plankton net. The conical net will catch anything that goes into it, but anything less than a tenth of a millimetre will go out through holes in the side. Tied on at the bottom of the net is a tube for collecting the plankton which cannot pass out through the holes in the net. The little planktonic animals are left in the tube with some water to swim in. Ideally the net should have a long handle so that you may reach far out into a pond without falling in.
3. Reach out into the pond and sweep the net down and up again in a semicircle. Bring the net to the land and let the water drain out from the net cone. If you have been successful you will see that the specimen tube on the net now has captured water-fleas in it.

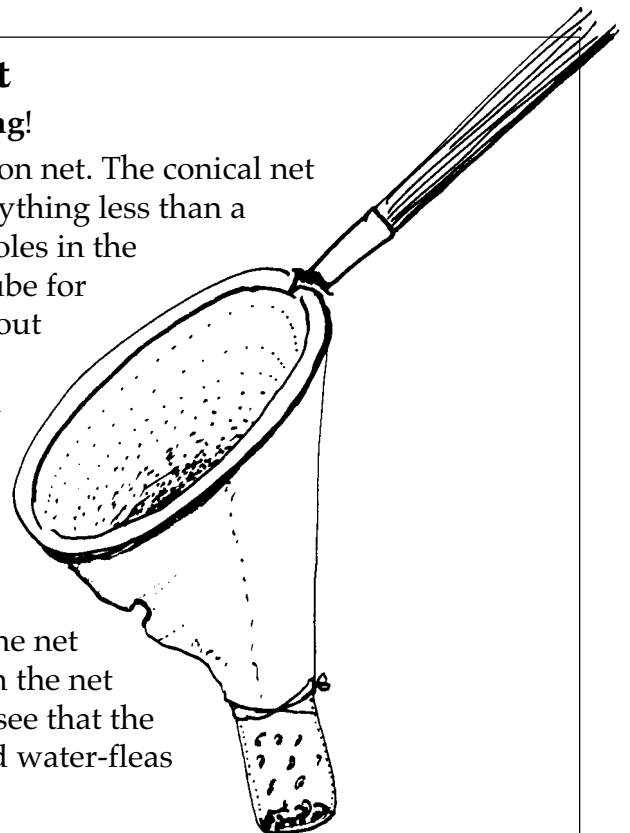

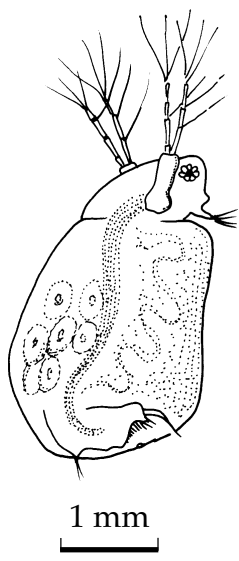

Simocephalus

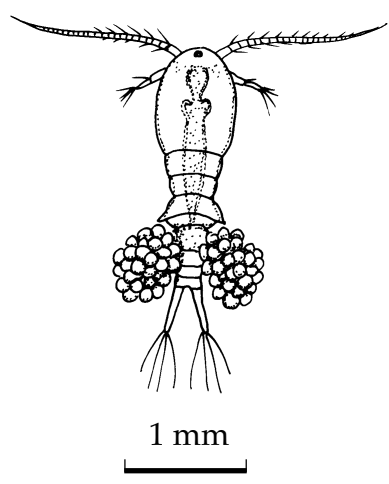

Cyclops

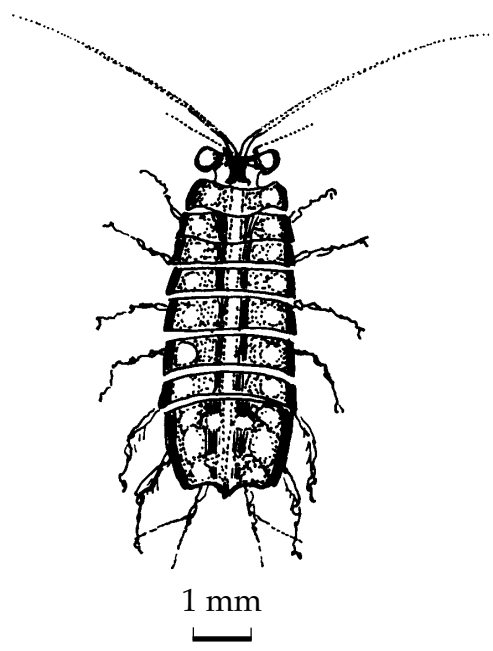

Asellus

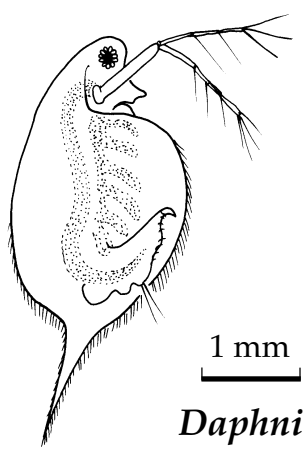

Daphnia

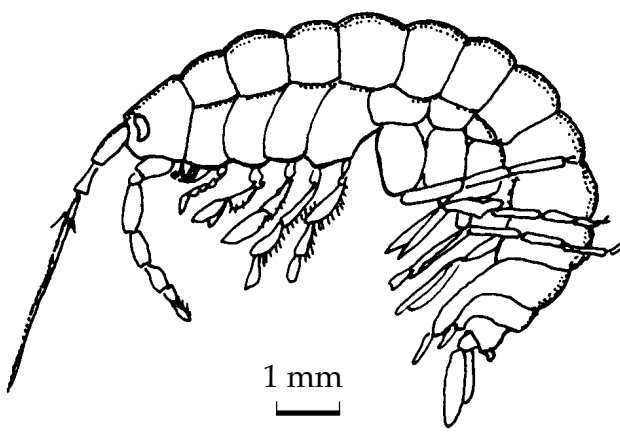

Gammarus

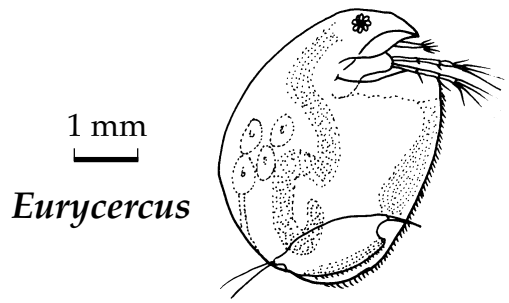

Eurycerus

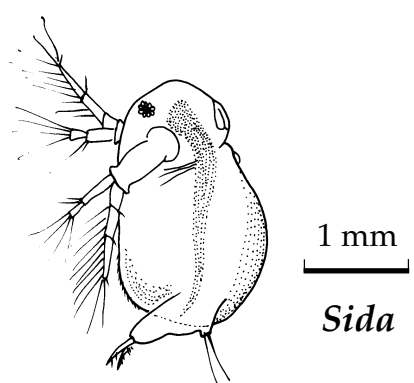

Sida

Some freshwater Crustacea

These genera of Crustacea are found in ponds or streams.

Note that beside each one is a scale line.

N.B. *Cyclops*, *Asellus* and *Gammarus* are not water-fleas.

Planning your water flea investigation

- When you have found a suitable place to study freshwater life you should plan either to study one species of animal or one particular habitat. What is your plan going to be?
- Next you need to make sufficient observations so that you can design the investigation well. What do you think you will do?
- What observations are important to make? What questions about the life of these organisms would you like to investigate? Think of some of the discoveries you have made about brine shrimps in the lab? You might make a description of the investigation site and perhaps a drawing of the pond or ditch in transect view.
- What hypothesis will you test? You might, for example, want to ask why the water-fleas are so concentrated in one place.
- What ways of sampling or counting will you use? How many sweeps of the net will you make. What samples will you take?
- What will you keep the same? What will you vary? What would make it a fairer test?
- What apparatus will you need? Perhaps you need more than a net?
- Do you need to measure the water pH, conductivity, oxygen concentration, turbidity, light, algal population, etc.?
- What exactly will you measure? How will you measure it?
- How many measures/observations will you make?
- Over what time will you need to do your experiment?
- Are there any safety precautions you need to take?
- Do you need permission to be where you wish to work?
- What do you need to take back to the lab?
- Do you need to study some books on pond life before you begin?

When you have planned fully

1. Make a list of all the apparatus you need.
2. Make your experimental plan.
3. Decide how you will collect your results.
4. Go out to the pond and do your investigation.
5. Bring back to your lab the materials needed for further study. You may want to set up a culture or an aquarium in the lab.

Results

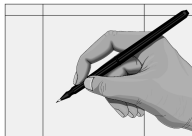

1. Collect your written observations and drawings.
Try to identify the species you use.
2. Put any quantitative measurements first into a table.
3. Express your results as a picture, diagram, bar graph or line graph.

The report



1. Write about what you think your pond investigation results prove.
2. Explain why your results fit any prediction you made, if they do.
3. Say what the odd results were and why they might have happened.
4. Say how you would improve your pond investigation were you to do it again.

Teacher's notes for student activities 1 - 13

ACTIVITY 1: Shrimp world - looking at the brine shrimp environment

Aim and teaching objectives

The broad aim of this class is as a 'starter' to engender interest and enhance motivation for anything that follows. The objectives are to encourage observation, recording, reporting and development of appropriate vocabulary. Most students will come up with at least seven observations on size, colour, motility, shape, sex or behaviour of the animals. The tracing activity has been found most rewarding. The physical measures of the environment are simulations of recording such things in a pond. *Brine shrimp world - the facts* can be class or homework reading. Learning a list of **shrimp words** might be instructive. A wide choice here of things to find out allows for a diversity of learning styles.

Background

Brine shrimp bottles are made up from 1.5 litre bottles ideally (see technical guide).

The sand and shell should be apportioned first to each bottle (2 cm depth), then at least a dozen shrimps of various sizes added, then the bottle filled with water from the holding tank so that one quarter of the bottle is air. Hydrometers are used for measuring relative density (specific gravity). Hydrometers suited to this investigation should calibrate between 1.000 and 1.200. The ideal relative density of water for brine shrimps is 1.03. The denser the liquid the higher the hydrometer will rise, as less of its mass will be displaced as it floats. The pH should be about 8.

Forward planning

Brine shrimp populations take at least three weeks to grow to maturity from hatching, the rate of growth depending upon the food quality. They will stay stable for several weeks, even months, in a class tank. **Early planning is absolutely essential to ensure there are good numbers of adult shrimps in the tank to provide students with sufficient for their studies.**

It's ideal if a school can set up 2 or 3 tanks, so if one population crashes there are other shrimps available for investigations.

Apparatus and equipment

- Student Activity sheet 1
- plastic shrimp bottles, one per two students. If the main stock brine shrimp tank is in this classroom this would be an asset. Never attempt to move a full aquarium.
- stop watch or clock, one per table
- several thermometers
- one hydrometer (with the teacher: this is an expensive piece of apparatus)
- pH papers.



Risk assessment

Bottles should be secured with a lid. Shrimp bottles accidentally dropped on the floor generally do not break.

Questions/answers

1. Any labelled drawings (see Section 4) from the teacher should be given out only after the initial student observations have been made and not before.
2. Brine is salt water. Relative density increases. There is no appreciable warming with salt addition.
3. Lake Mono (California), Great Salt Lake (Utah), the Dead Sea (Israel), The Rift Valley Lakes (Kenya). There are salt 'flashes' in Cheshire and the lower Aire Valley in Yorkshire. Brine shrimps were once recorded from coastal salt-pans in Lymington Dorset. It is believed that they do not occur in the wild in Britain any more!
4. They are all crustaceans except the snail, which is a mollusc.
5. 10 in a litre would be comparable to densities in the wild. This is equivalent to ten thousand shrimps in one cubic metre.
6. 'Mate guarding' is the usual explanation, i.e. mate choice by males of females and/or females of males. Thinking about this question is a good lead into later ideas.

ACTIVITY 2: Variation in brine shrimps

Aim and teaching objectives

The aim of this class is to concentrate in more detail on the appearance and variation of the animals in the ecosystem. Skills of handling, observation, measurement and recording will be learned. Students will learn that repetition of measures improves reliability. Graphed results will show a significant difference between the sizes of the two sexes. Extension work might include the objective of some introduction to microscopy beyond the use of a hand-lens. Some challenging hypothesis making is involved at the end.

Background

One of the original observations made by students will be that their shrimps are not all alike. This practical builds on that perception. There is a strong sexual dimorphism (see guide-line drawings) in the second antennae. Males have large clasping structures. The females have a very obvious brood-pouch containing eggs.

Brine shrimps differ in size as they grow and differ as adults for after their last moult they do not grow greatly in size. Their size is therefore a reflection of the quality of growth conditions (in poorly nourished tanks they are smaller). Overall, males are generally shorter than females. The fact that larger females invest more successfully in their young is a possible explanation of the difference. This may be established by this investigation. Measurements **must** be made to the nearest millimetre.

Forward planning

Brine shrimp populations take at least three weeks to grow to maturity from hatching. The rate of growth depends upon the food quality. Students could work in groups with a binocular microscope or with a good magnifier. Roles could be rotated in the group.

Apparatus

- Student Activity sheet 2 & work card *Handling and observing brine shrimps* (page 6)
- a clean glass microscope slide
- a low power microscope or powerful magnifier
- a sheet of 1 mm graph paper or, better still, OHT photocopy of graph paper cut up into strips
- a polythene pipette - cut with a wide mouth to capture the shrimps from the tank
- two 250 cm³ glass beakers
- a supply of salt water (400 cm³ per working

group at a concentration of 30 - 35 g per litre)

- approximately ten adult shrimps, five females and five males. Preferably these should be fished for by students from the tank with a tea strainer, or poured out from bottles.



Risk assessment

Microscope slides are a possible source of danger. **Warn students about the danger of glass.**

Notes on procedure

1. The glass slide should be clean and dry and is better slightly greasy and detergent free. The water droplet then stands up proud.



2. It is most important that students are aware of the need to minimise harm to the animals. Five minutes could be deemed an acceptable time to have a shrimp in a droplet of water on a microscope slide.

Class findings

Histograms are most suitable for these data. Putting the bar lines above and below a single horizontal line will give a simple length comparison of male and female shrimps.

Really good ecological data may come from this investigation, especially if information on egg numbers and mate pairings is also available. There is clear evidence that brine shrimps assort by size when mate-guarding, larger females being mate-guarded by larger males. This may also be related to success in reproduction.

Extension

Egg numbers may be counted most easily with the low power of a monocular microscope. This does require some skill.

Questions/answers

1. Female shrimps are on average more than a millimetre longer.
2. There is not thought to be a difference here.
3. How old it is, its food supply.

Yes; there is evidence that larger shrimps select larger partners. This also happens in the British common frog, a species in which the number of offspring produced relates to the size of female.

ACTIVITY 3: The hatching of brine shrimps - investigating physical factors

Aim and teaching objectives

The aim of this class is to reinforce the fact that physical conditions dictate survival for many organisms. Skills of handling tiny egg cysts will be learned. This is difficult but necessary to gain quantitative knowledge. Students should understand that repetition of measures improves reliability. Emphasis should therefore be given to the importance of the whole class result. Team work is a skill. Graphed results will show a significant difference between conditions. The most able students might be in the pH team.

Background

Students will know that shrimps need a warm and sunny environment with salt water. Here is an opportunity to consolidate quantitatively their appreciation of what the shrimp natural environment will need if egg cysts are to hatch. Some discussion of a salt lake at the end of a hot dry season when the rain comes might be an appropriate curtain raiser. **This links biogeography to a lab-based directed investigation.**

Forward planning

Brine shrimp eggs may be obtained from most pet shops and aquarists. They should be dry and powdery. Test them for hatching at the conditions you will use in class. 48 hours should give the most complete hatch. 50% hatch rate is satisfactory. Egg cysts have an effective 'shelf-life' of many years. *Instant Ocean* sea salt is fully balanced with nutrients. If this is not available ordinary 'sea salt', without additives, from a health food shop is as reliable. Brine shrimps will also hatch in ordinary household salt (sodium chloride) solution. Ideally, students should work in multiples of three groups.

The sheet *Counting out shrimp egg cysts* (page 16) could be run off on the back of each team's work card.

Apparatus

All teams

- main instruction sheet on counting out egg cysts
- the work cards 'salt team' 'pH team' and 'temperature team' as appropriate
- forceps and scissors
- a quarter of an A4 sheet of graph paper and clean white sheet of A4 paper
- a magnifier
- a tiny pinch of egg cysts (best given out by the

teacher in the class). Working from 100 egg cysts gives an easily counted %. Fewer egg cysts could be used, perhaps 50 or 25.

The salt test team

Each team will need:

- six 100 cm³ beakers or clear plastic cups
- *Instant Ocean* sea salt
- a means of weighing out salt accurately
- 600 cm³ de-chlorinated tap water
- a spatula for stirring
- a label for each beaker/cup.

The temperature team

Each team will need:

- four 100 cm³ beakers or clear plastic cups
- *Instant Ocean* sea salt
- a means of weighing out salt accurately
- 400 cm³ de-chlorinated tap water
- a spatula for stirring
- a label for each beaker/cup
- a refrigerator (5° C)
- two water baths or incubators, or other warm places maintained at 30° C and 40° C.

The pH test team

Each team will need:

- six 100 cm³ beakers or clear plastic cups
- 600 cm³ of *Instant Ocean* sea salt soln. (2% in de-chlorinated tap water)
- a spatula for stirring
- a label for each beaker/cup
- some pH paper strips
- a pipette dropper bottle with 1M sodium carbonate solution
- a pipette dropper bottle with M/10 hydrochloric acid.

Risk assessment



Glass pipettes are really essential for counting up the larvae. **Warning should be given about the danger of injury with the glass.** Normal risk assessment warnings should be given for the acid and base solutions and for the correct use of scissors.

Notes on procedure

1. Egg cysts hatch between 24 and 48 hours.
2. Hatching may be checked by holding the beaker up to a light. The nauplii larvae swim to the light. They may be collected in a pipette.
3. Larvae should be fed initially on *Liquizell* or added to a main tank with algae soon after hatching. If the following class is more than two days ahead *Liquizell* should be added, one drop per beaker.

Class findings

The results given below are typical. Considerable variation in optimal hatch rate between batches of egg cysts may be found: 50% is typical for a good rate of hatching. The numbers in the tables are the

number of shrimps hatched for every hundred eggs put in the water. Optima are from published sources.

Extension

Bright light has an additional promoting effect on egg cyst hatching. This is a further independent variable for investigation.

Questions/answers

2. Replication of each test would increase accuracy of answer.
3. Increase the sample size and increase the range of variables.
4. Because 100 eggs were used.

Salinity (experimentally known optimum 2.8%)

% salt	0%	1%	2%	3%	5%	10%
nos.	0	12	50	47	45	32

Temperature (experimentally known optimum 28° C)

temp.	5° C	20° C	30° C	40° C
nos.	0	20	50	5

Acidity-Alkalinity (experimentally known optimum 8.5)

ph	5	6	7	8	9	10
nos.	0	0	10	50	45	10

ACTIVITY 4: The first food

Aim and teaching objectives

The aim of this class investigation is to discover quantitatively how the survival of nauplii is related to the quality of food available. It introduces the important ecological concept of survivorship, as newly hatched shrimps will grow into adults. Algal food that may grow in the microbial community is compared with a commercial shrimp larva feed, *Liquizell*. The aim is therefore to test the claim of the manufacturer that it “eliminates premature mortality” !

The use of replicate experiments is now pushed harder as a more sure indicator of confidence in science. The class are required, from their own reading of the investigation, to produce their own very simple hypothesis. Hypothesising becomes more important in the investigation that follows. Skills of catching and counting larvae are repeated again.

Background

The microbial community is complex. Ideally there should be small sized algae in abundance at the time of hatching. This may not always be the case and is a severe limiting factor on shrimp survival. If *Liquizell* is unavailable, a milky consistency of fresh baker's yeast may also serve as a supplement. The added yeast suspension should be so thin as to only just make the water slightly cloudy.

Forward planning

Freshly hatched shrimp larvae are needed. A 1 litre beaker of 3% (30 grams/litre) sea salt to which a pinch of egg cysts is added at least 24 hours before should produce enough larvae. Incubate at 28° C.

Apparatus

For each pair

For setting up the experimental containers

- a 250 cm³ beaker or open topped plastic bottle
- sea salt
- de-chlorinated tap water
- a spatula for stirring
- a label for each beaker
- a dessert spoon.

For counting out newly hatched larvae into the beaker

- a small beaker of nauplii
- a small glass pipette
- a bench lamp.

For side bench

- a means of weighing out salt accurately
- a funnel, if plastic bottles are used rather than 250 cm³ beakers
- substrate from the main brine shrimp tank
- a bottle of *Liquizell* (not needed by the algae team).

Apparatus

For next or following lessons **for counting the surviving larvae.**

For each pair

- the 250 cm³ beaker used in the experiment (or plastic bottle)
- a pipette
- a bench lamp
- a 100 cm³ beaker to receive larvae
- a calculator to work out the percentage survival.



Risk assessment

Care should be taken handling glass pipettes.

Notes on procedure

The tray of shrimps must be illuminated brightly between classes. Some algae will grow and will thereby oxygenate the water.

Class findings

Mortality is likely to be less with *Liquizell*, that is survivorship is greater, but either way it is worth discussing how real the difference seems to be, so preparing the ground for a later 'significant difference'.

Extension

Some students should be encouraged to set up experiments arising from the class questions. They could be put on to this in class time if all is completed.

Questions/answers

1. It is claimed that *Liquizell* ensures greater survival.
2. The algae could be omitted from a true control to which *Liquizell* only was added. A further control might be salt water alone. This last is instructive for the nauplii will all die in a few days without food.
3. The microbial addition is hard to standardise. It is assumed that they are mixed up evenly in the tank.
4. *Liquizell* is only added at the start. How much is actually needed and in what amounts before the shrimps gain full independence? (See *Liquizell* manufacturer's notes.)
5. Single species algal culture? Examine microscopically the gut contents of the fastest growing larvae? Opportunity here for higher level skills in experimental design.

ACTIVITY 5: Testing the algal food hypothesis

Aim and teaching objectives

The aim of this investigation is to begin a more open-ended science exploration testing the hypothesis that shrimps do feed on algae. Many different investigations may be devised by students for this topic. It would be suitable as a **Science 1 investigation**.

Some brain-storming may lead to several lines of investigation. Some of these will be short and some longer term. They will differentiate by task chosen and by outcome. At its simplest, this task will challenge students to wrestle with understanding that things which they cannot easily visualise may well be very important in an investigation.



For example, they might suggest that the shrimps be separated from the algae and given only a salt water diet. With a control carried out over a few days, the experimental shrimps would survive but not grow and when simply observed their guts would have no algae in them. Another group might see that the algae without shrimps will grow and multiply and the water become greener. Here a control experiment would have shrimps and algae and the experiment itself algae alone. 'Greenness' could be measured on a devised colour scale (or better still in a colorimeter). These first two experiments complement each other. Microscopy skills may be introduced here. The numbers of algae in the field of view for just one drop of water can be counted. Though very rough as an estimate compared to the use of a haemocytometer, this is a valid measure. Alternatively, a standard volume of shrimp water may be filtered and the colour of the filter paper assessed.

Further experiments looking at the growth requirements of the algae may be done. Light, nutrients and warmth may each be investigated. There is an opportunity here for **data-logging**. Changes in light and pH may be correlated. pH rises during photosynthesis, as carbon dioxide levels are depleted. In the dark, carbon dioxide levels rise and pH falls (see Section 5, *Laboratory Technician's Guide*).

As with all National Curriculum Science 1 investigations, assessment may be made of each student's capacity to develop a scientific method of working. The planning questions have been provided with this in mind.

Students will be expected to:-

- demonstrate knowledge
- develop ideas and hypotheses
- make predictions
- design a fair test
- identify suitable variables
- select apparatus
- define a procedure
- make observations
- select measurements and take them accurately
- present their results in tables and graphs
- explain and discuss their results
- draw conclusions
- show awareness of anomalies, etc.
- work safely.

Background

The following support suggestions are offered:-

1. Separating shrimps from algae

- (a) A cotton or linen pocket handkerchief is ideal for separating shrimps from algae. Spread the handkerchief over and into the filter funnel and then pour a shrimp suspension through it. After the algal suspension has been collected the shrimps from the handkerchief are easily returned to the tank.
- (b) Beakers with equal amounts of algae, but with and without shrimps, may be compared to see if the green colour diminishes in the presence of the shrimps over time. This effect is observable after a few hours but it is better to make a comparison over a full day. A single adult shrimp filters 100 cm³ per day. Remember, though, that algae may double daily also!

2. Direct observation of shrimps and algae

- (a) It is easy to establish the particulate nature of the algae by placing some strong green suspension on a microscope slide and viewing under high power. This will perhaps help the concept of algae as cells and not a sort of green colour or slime.

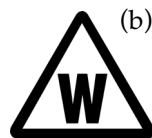

- (b) To look at the gut and the filter-feeding (phyllopod) limb movements place an adult shrimp in a drop of water on a plain slide surface under a binocular

microscope or low power microscope. If the slide surface is detergent free and greased slightly, the droplet of water in which the animal is placed will stand proud with surface tension. Adult shrimps may be safely pipetted with a large plastic teat pipette from which the end has been sliced off to an appropriate diameter. The green

colour in the gut of the shrimp is very striking. Green cells may be observed directly.

- (c) One drop only of tank water placed under a high power microscope and focused by the teacher will reveal cells that are visible and countable in the field of view. This is rough quantitative work. Advanced students might consider the use of a haemocytometer to measure the number of algal cells per unit volume. A good green algal suspension will have about a million cells per centimetre cube.

3. Indirect observation of algae

- (a) A simple algal density may be assayed by filtering tank water and looking at the colour of the filter paper.
- (b) A greenness colour scale may be devised for visual comparison of colours in a fixed volume of water.
- (c) Colorimeters may be used to measure algal concentration. A litre of water may, for example, be filtered. The algal precipitate collected may be washed off the filter paper into a single test tube with propanone and the chlorophyll density measured in a colorimeter (use a purple filter).

4. Bottle of shrimps in the light and the dark

Plastic bottles of shrimps may be set up in the light and in total darkness. Use a warm cupboard. Bottle cultures will be able to show growth differences best if the shrimps are not adult but are half grown. A bigger difference in growth will be apparent if the water in the bottles is warm (25-30°C). This experiment will take a week. Shrimps kept in the dark will grow less quickly and will eventually (depending on their conditions) run out of algal food. Students might therefore prove that light is needed for them to grow well. Brine shrimps fed on a suspension of yeast cells **in the dark** (with an aerator) will thrive if the oxygen level remains high.

5. Increasing algae with plant fertiliser

Most tap water in southern Britain contains enough nitrates to encourage algal growth (Cambridge tap water, for example, is rarely below 30 ppm). One tenth of a gram per litre of potassium nitrate made up in distilled water contains about 50 ppm nitrate ions. This will give a rapid algal response. *Baby Bio*, which contains nearly 10% urea, produces an equivalent dose at 10 drops per litre but the conversion to nitrate is slower as the conversion relies on nitrifying bacteria in the water/soil. Overdosing with fertiliser will cause death of algae. This is investigated in Student Activity 12 and it may confuse things at this point if too much is added.

Forward planning

At least one large tank of shrimps will be needed for this investigation. It would be preferable if there were several bottles and tanks. This investigation will take at least three weeks of class time in all but other shorter experiments (e.g. *Student Activities 10 and 13*) might be done whilst waiting for the results.

Teachers need to remind students to order their equipment ahead of time.

Apparatus

See notes on investigations above. The following may be called for:

- brine shrimp tank for the whole class plus bottles of brine shrimps, preferably about one week after hatching and growing well
- all equipment for handling, growing and examining shrimps, e.g. small fine sieves, etc.
- fine cotton or linen cloth, such as a handkerchief
- filter funnels and jugs and other means of pouring water. Spare plastic bottles as containers
- microscopes and lamps
- slides and coverslips
- students may well want all sorts of other things for their own investigations.

Risk assessment



There are no specific risks other than those attached to using glass pipettes. Care should be taken with expensive apparatus. If a colorimeter, haemocytometer or good high power microscope are used warnings will be needed on their safe handling.

Class findings

It is suggested that class findings be presented by research teams at a meeting.

Commercial rearing of *Artemia*

Teachers interested in the commercial rearing of *Artemia* (outside an ecosystem) should refer to:-
<http://www.aqualink.com/marine/z-temia.html>

ACTIVITY 6: Shrimps galore - setting up your own bottle ecosystem

Aim and teaching objectives

The aim of this teaching unit is to provide the student with a brine shrimp bottle which they may take home and from which they will make daily observations (see figure on page 2 of this book). Besides the discipline of following the instructions in setting up the bottled planet and keeping the diary, this aid to understanding ecological relationships will be instructive. The role of light in primary production, the growth of individuals, their mate-guarding and reproduction will all be observed. The brine shrimps will eventually die of old age but a new generation will often hatch in a few days. The concepts of nutrient re-cycling will be enhanced (there is often a bloom of algae after the shrimps die and a new generation growing up again with the flush of algal growth). This exercise is highly motivating to students of all ages. It will engage the rest of the family at home and, it is hoped, have a positive feedback on school performance.

Background

Study Section 5, pages 92-93 and 96-98 as well as the Introduction. Bottle ecosystems last many months before they run down. The larger the bottle ecosystem the more stable it will be.

Forward planning

Students will need their own **bottles with lids** for this to be manageable. The best bottles are clear and straight sided ones with as little scratching on the plastic as possible. Soda and mineral water bottles are good.

Sand and shell will be needed (0.2 kg per bottle): students could find their own and make this a variable to be tested.

You will need 30 g of **sea salt** per litre. Sea salt will be basic. Kitchen salt is better than nothing, but should be made basic with sodium carbonate (washing soda) to get the pH to over 8.0.

Egg cysts could be used for hatching in the bottle if the water reaches the required temperature (25 - 30° C). It is better to send the bottle planets home only when larvae have been successfully established. Shrimps of all ages should be available for addition.

Apparatus

- lots of suitable bottles (many hotels throw away huge numbers of mineral water bottles, the ideal

is a clear clean plastic bottle between 1 and 3 litres)

- some sand and oyster shell, preferably washed
- sea salt (*Instant Ocean* is recommended, but sea salt for cooking is adequate)
- de-chlorinated tap water (a bucket full standing for 24 h is OK)
- a source of the microbial community from the tank bottom (dessert spoon)
- plastic funnels for putting sand and shell in bottles
- measuring cylinders
- spoons or spatulas
- balance
- Baby Bio* fertiliser with pipette droppers
- some brine shrimps, adults, newly hatched or a tiny pinch of eggs per bottle.

Risk assessment



Low risk. Ask students to tell parents that the bottle planet is completely safe and has no hazard.

Notes on procedure

This is likely to be a chaotic practical lesson, but student motivation will be high to get it right for their own bottle. It might be a good idea to run some other settled activity parallel.

Class findings

The great outcome is the diary. This could lead to a discussion, posters and displays, etc..

Find out on the internet about BIOSPHERE 2, and brine shrimps on the NASA space programme.

ACTIVITY 7: Exploding populations

Teaching objectives

Students must by now be able to tell the sexes apart. In three or four weeks this experiment should produce some very telling results on the clear relationship between food supply and population growth. In every bottle the experiment may not show a clear distinction but with the three replicates there should be a clear mean difference. The students are asked to make their own hypothesis. They are also asked to make their own table of results and devise their own graphs. Students will need to watch for hatching events and be vigilant observers.

Background

The experiment requires some addition of tank substrate. This is needed to provide the continued release of algal nutrients for three groups of experimental populations equally. The *Liquizell* should ensure good survival of hatched nauplii and a strong differential food supply. As long as the 0:1:3 differential between the three sets of experiments is maintained the result should be clear. The experimental design means that you will have three replicates of each of the three conditions. It would be advantageous to use females and males that have only recently reached sexual maturity. If you can arrange to use a fairly recently hatched set of shrimps for this experiment that would be good. If one, or both, adults die before the eggs are laid then replace the dead adult with another of the same sex. Students could show you their pairs for you to check.

Forward planning

Young adult shrimps would be an advantage at the outset. **It is suggested that these be hatched just two to three weeks before the practical.** They should then be able to be sexed but not yet necessarily paired up. This investigation should have some long term source of heat and light if done in the winter. A south facing window-sill will be fine in the summer term otherwise.

It is suggested that nine bottles is the minimum number for a whole class. The experiment, as written here, need only therefore be done once by **the whole class.**

Apparatus

- nine plastic bottles (or beakers), 330 cm³ are ideal
- salt water (a concentration of 30-35 g per litre - this needs to be made up first). Allow nine litres for the whole experiment (there are 15 litres in a typical plastic bucket)
- teat pipettes, or dessert spoons or sieves
- nine gummed labels to identify each bottle (or beaker)
- substrate from the main brine shrimp tank
- bench lamps - to provide a source of heating and lighting for the shrimps during the month, or term, that the experiment is running
- liquid fertiliser and *Liquizell*. One bottle will easily supply a whole class for this experiment. (see suppliers sheet). If you have no *Liquizell*, yeast suspension is a less good, but real, alternative. With yeast, oxygenation is needed as the algae may not provide oxygen adequately.

Risk assessment

No hazards are envisaged.

Notes on procedure

1. To do this whole experiment as a full class experiment will mean that there is one bottle to be looked after for n/9 students. Two parallel experiments would mean that one or two students could deal with each bottle. There will be a lot of counting to do if the bottles are large and the experiment runs for several weeks.
2. It is important to ensure that there are a mating and viable pair in each bottle. You might check on this after the initial class.

Class findings

A data table will be needed with at least ten columns. The optimal design might be as shown at the top of the next page.

Extension

The difference between arithmetic and geometric progressions should be clear to the most able. You might suggest that they work out theoretically the rate of population increase (r) from the data at the end of the Challenge.

Experiment	0 drops per week				5 drops per week				15 drops per week			
Replicate bottles	A	B	C	A - C total & average	D	E	F	D - F total & average	G	H	I	G - I total & average
Date				A - C				D - F				G - I
<i>3rd May</i>	<i>12</i>	<i>15</i>	<i>18</i>	<i>Total = 45 Average = 15</i>								

Questions/answers

1. The purpose of the experiment is, in part, to show the constraints on the holding tank's own carrying capacity. It will not have grown proportionally in population as much as even the control bottle.
2. Each bottle tends to behave slightly differently. The larger the bottle ecosystems the more steady they are likely to be.
3. Studies on the Great Salt Lake Utah (Cuellar 1990) indicate that the frequency of females rises during the boom of summer populations and that the males become predominant at the close of the season. Statistically significant departures from a 50:50 ratio would suggest this strategy was one for optimising egg production in the good times. The mechanism for this imbalance between the sexes is not understood.

ACTIVITY 8: Predatory shrimping

Aim and teaching objectives

The aims of this investigation, which needs only three weeks to show an effect, are to simulate the behaviour of a predator. This is done by students role-playing the flamingo.

Students will, of course, gain knowledge of the effects of a predator in reducing the population but also the effect of a predator in not reducing the population severely should be apparent. This will be true if the tank population is close to its carrying capacity.



There is an important **ethical discussion** at the outset about how to dispose of the animals caught. Some students will enjoy feeding the fish and want to see what happens when they do. Certainly there will be others who will not want to do this at all. **One may legitimately defend, and so must absolutely respect, either of these strongly held positions.**

There is a rota of activities involved and this is therefore **not a full class investigation** but one that could be set up in one lesson to run parallel to other class activities for the duration. At the end of the unit is some serious computational work which will require good maths skills.

One very effective way of linking this to a real food chain is to see some film of flamingoes in a salt lake environment. Another device that has been found most memorable to students is a **pink cardboard cut-out flamingo** which stands by the tank. With an articulated pivot at the base of the neck you can dip its head in the water.

Background

When a predator takes prey from a population it is likely that it will catch the ones least able to escape. These will probably be the weakest and oldest.

The **size of the mesh** makes a difference to the catch.

The size, and hence age distribution, of the prey caught is affected by mesh size - see the last question asked. Small mesh sizes catch many juveniles and depress recruitment to the population. The age classes already in the population will also affect the resulting population size and structure. The outcome of the investigation is thus largely determined by the stage of the population in the tank that is being preyed upon. The population may therefore fall drastically, or it **could** stay exactly the same as the control.

Forward planning

It is best to have a population for this experiment that has mixed age classes, i.e. lots of little nymphal stages as well as bigger brine shrimps. Mixing different populations together will achieve this result. At least two tanks, even if they are small, are needed and they must be started off from the same larger population at the outset to make it a fair test.

Apparatus

- two equal size and roughly equal population tanks of brine shrimps of mixed age-classes
- a tea strainer
- a 400 cm³ beaker
- a third tank **OR** an aquarium with fish in it
- four 250 cm³ beakers for sampling the tank populations
- calculators, graph paper.

Risk assessment

No risks are anticipated.

Notes on procedure

1. It is important to standardise the sieve size and the sieving procedure. The larger the mesh size the fewer young shrimps will be caught. The smaller the mesh size the more representative of the whole population will be the prey. The speed of sieving also makes a difference. The large shrimps may swim away from the predator faster and so escape predation. Fair testing is essential. **It is suggested that one sweep of the tank be made in about 3 seconds only, without looking for the prey!**
2. It is vital that students understand that the predated shrimps are removed to the right place and the sampled ones be returned to the same tank population.
3. Fresh water is used to wash the shrimps and to prevent salination of the goldfish tank. Brine shrimps are able to live in fresh water for several days.

Class findings

Anything may happen to the population for reasons already given. It should be found that the predated shrimps plus predated tank population is greater than the non predated tank.

It should not be assumed that the prey will decline in numbers but it is likely to do so.

Extension

The more able will have plenty to think about with the questions, some of which are quite challenging.

Another extension might be to write an imaginative prose account of Penelope Jenkin's trip to the Kenya Rift Valley Lakes in 1929. She was a tall and energetic woman who was an expert on birds and their prey. At the time she went to Africa she lived in a very different culture from ours today. East Africa was also then a very remote and wild region. She had to watch out for lions coming to drink at the lakes she was studying. There were also crocodiles around, so she had to look out for her predators too! Probably she noticed the eagles that prey on the flamingoes. It was Penelope Jenkin who first saw most clearly how Crustacea fit into the flamingo food chain. A wall display of the brine shrimp food chain would be a good idea.

Questions/answers

1. It should be less, but if the starting population is growing rapidly predation may not suppress net growth.
2. There will probably be a difference here but if there is not it still provides interesting discussion, (see notes above).
3. As calculated.
4. This might produce a significant difference. It should be found that the predated shrimps plus predated tank population is greater than the non-predated tank.
5. Answers are 1.3 mm and 0.2 mm.
6. Adult brine shrimps average 10 mm; nauplii start at 0.4 mm and quickly grow to 2 mm.
7. The flamingo can therefore catch any size of brine shrimp.
8. See 'notes on procedure' above.
9. Fishermen want the smallest mesh sizes so that they can catch more fish. The Governments often want them to use a larger mesh size so that they do not over-exploit the fish stocks. Some governments accuse other governments of allowing smaller mesh sizes than they allow themselves. The result is that the fish suffer great exploitation.

ACTIVITY 9: Are shrimps vertical commuters?

Aim and teaching objectives

This is an exercise in the ecology of foraging behaviour. The different ages and sexes of brine shrimps need different sorts of food. At the bottom of the bottle there is a lot of detritus on which the animals can feed if algae are short. This investigation need not take very long. For one student group it produces three sets of simple quantitative data which could easily be graphed in less than an hour. The questions at the end are targeted at student's understanding of the experimental method and are intended to encourage them to develop more critical experimental designs. Questions also probe assumptions and encourage the students to ask the kinds of question that an observant scientist will ask.

Background

Amongst animals there is often an age difference that affects diet. Sometimes it is an extreme difference, such as that between caterpillars and butterflies, where the diet of the two ages is totally different. For others the prey increases in size as the animal gets larger. For example, young crocodiles eat dragon flies, then small fish, bigger fish and finally antelopes that come to drink at the river side. The younger shrimps are often found away from the upper surface. The males seem to move up and down the water column and wander all over the place whereas the females tend to feed at the bottom more than any other group. Perhaps when algae are short the bottom provides the best food. The assumption is not made that each animal will behave in the same way when they are together rather than apart (Question 2).

Forward planning

Relatively few animals are needed for this study. A lot of bottles are needed, however, almost one per pair of students. Where the class number is n , $n/2$ or $n/3$ bottles and stopwatches will be needed. The list below is for 1 such group.

Apparatus

- a plastic bottle (or beaker) - a clean soda or cola bottle will be perfect for this, if unavailable a beaker will be fine
- two elastic bands
- a supply of brine shrimps - one male, one female and a young shrimp per group
- salt water
- a dessert spoon or sieve
- substrate from the main brine shrimp tank

- a plastic teat pipette (or the dessert spoon or sieve), to catch shrimps from the tank
- a stop watch, or stop clock
- a 30 cm ruler
- a small glass beaker of 100 cm³ or 200 cm³.

Risk assessment

No hazards are foreseen.

Notes on procedure

- 1 Students might work in pairs taking it in turns to be (a) observer and (b) stop watch operator and data recorder. One or other student must observe **all the time**.
2. Directions as to data handling are given in the student sheet under 'Results'.

Extension

Those students that complete their own data handling should gather that from other groups together. The collected data will lend themselves to more thorough graphical analysis, together with calculations to determine the mean time spent in each section by male, female and young shrimps.

Questions/answers

1. Control for bottle size and shape.
2. Yes probably - males might be looking for females.
3. Algae/food might be found at different depths. There might be more oxygen near the surface.
4. Look, at night, with a dim red light or suddenly flash a light and see.

ACTIVITY 10: Speedy shrimps - fleeing and finding a mate

Aim and teaching objectives

Animals are characterised by their movement. Generally smaller individuals are slower than larger ones, and there may be differences between the sexes even if they are the same size. It will be discovered that male shrimps are faster than females, despite their large clasping antennae. Here some experimental skills (such as using a stopwatch) lead to this observation and to hypothesis making which may suggest reasons for the differences observed.

Background

As shrimps increase in size they increase their swimming speed. Although larger females can swim at a high speed, they often cruise at a significantly slower speed than the males. Surprisingly, for one would expect a drag on their large clasping antennae, the males generally swim faster.

Forward planning

This experiment requires the making of a piece of apparatus. Large soda-glass tubing with a 10 mm bore is ideal. The tubing should be cut to about 30 cm in length and corks or rubber bungs fitted at the end. Ideally there should be one of these between two in a class. The tube needs to be just wide enough for an adult shrimp to turn around at the end but narrow enough to keep them swimming straight. The plastic tubes used for long thermometers are also very good for this experiment. A range of adult and young shrimps are needed.

Apparatus

- a stop watch (or stop clock)
- a length of glass or plastic tubing (bore about 10 mm) with corks fitted
- some clear salt water (this can be taken from the brine shrimp tank or can be made up separately)
- a sheet of graph paper and a piece of Blu-Tack
- a plastic teat pipette (this needs to be made big enough to allow a shrimp through), or a sieve
- brine shrimp tank or supply of all age shrimps.

Risk assessment



No hazards are foreseen though students need to be reminded that they are handling glass (if this is the case) and should be aware that the ends may not be absolutely smooth, with particular care being taken when pushing the bung into the tube.

Notes on procedure

1. Students need to take great care when catching the shrimps; they have very delicate leafy-legs and if their appendages are damaged this will affect how fast they can swim. This needs emphasis. Shrimps are best caught with a plastic pipette with the end cut off (see page 6 *Handling and observing brine shrimps*) or using a sieve.
2. The length of each shrimp may be measured using the method described in the procedure section of *Variation in brine shrimps* page 10.
3. After students have used a shrimp they should measure its length and then put it back in the holding tank or bottle.

Class findings

The speed of juveniles is roughly proportional to their length. A scatter diagram might be plotted using the whole class results, plotting the dependent variable (speed) on the y axis against the independent variable (length) on the x axis. Males swim about half as fast again as females. A class discussion might end the lesson, concluding that females reserve their energy for egg production, whilst males may be speedily swimming around looking for females.

Extension

The more able should collect up other groups' data. They might also investigate the speed of tandem pairs which travel at speeds comparable to males on their own. This is interesting as a male may thereby enable a female to filter more water and invest more food in egg production.

Questions

For possible answers see class findings (above).

ACTIVITY 11: Altering the balance - pollution studies

Aim and teaching objectives

This unit offers a first hand experience of investigating the beneficial, neutral or harmful effects of substances added to the environment. Students need to understand that a pollutant is a substance which, when added in sufficient quantity to the environment, causes harm. Understanding the effects of that harm as a product of two components, namely the **dose of the pollutant** and the **duration of the exposure** of the organism to the pollutant, is important.



Teaching this unit by practical work is possibly controversial. *Simazine* is the pollutant recommended for investigation. This has the advantage of being highly toxic to algae (at a dose

of 1 part per million), but is completely harmless to shrimps at more than ten times this dose. **The teacher should know this fact if asked by the students.**

Pollution investigations certainly make it possible to understand the process of pollution better. The conceptual understanding of pollution effects will be greatly enhanced by observation of organisms exposed to potential harm. Here the shrimps will not be harmed but they will grow less quickly as they are deprived of algal food for a few days as the algae will have been killed by the pollution.

Many teachers and students might prefer to make this a **Science Investigation**. As with all National Curriculum Science investigations assessment may be made of each student's capacity to develop a scientific method of working. The planning questions on the student sheets have been provided with this in mind.

Students will be expected to:

- demonstrate knowledge
- develop ideas and hypotheses
- make predictions
- design a fair test
- choose suitable variables
- select apparatus
- define a procedure
- make observations
- choose measurements and make them accurately
- present their results in tables and graphs etc.
- explain and discuss their results
- draw conclusions
- show awareness of anomalies
- work safely.

Background

Pollutants are defined as substances which, in sufficient quantities, upset the balance of an ecosystem and cause harm to the organisms within it. Pollution is a phenomenon that is best studied in its ecological context and which can be understood in that context by looking at the individual effects of the pollutants.

In the experiment with *Simazine* herbicide it is only the algae that are adversely affected whilst the brine shrimps are not directly affected at all, though they cannot live indefinitely without algae. **The initiation of this experiment should not be imposed upon students without discussion.** This presents a fine opportunity for ethical discussion and debate.

Forward planning



Simazine herbicide should not be purchased commercially. It is found in many herbicides available at most garden centres but it is often mixed with other compounds that may be more toxic to animals and could also be harmful to students. It is recommended that you buy the pure herbicide at 1% strength from Homerton College with relevant Health and Safety Data sheets approved by CLEAPSS (see Technicians Guide page 98).

You will need a good supply of young shrimps and a good algal culture. It is realistic to do this investigation over two weeks, but results may be apparent with the algae and brine shrimps in *Simazine* in two or three days. The loss of algal 'green' and the decline in shrimp growth rates are dramatic.

Apparatus for the *Simazine* investigation (per group)

- adhesive labels
- a stirrer
- 20 juvenile brine shrimps (access to brine shrimp tank)
- a dropping bottle containing 0.1% *Simazine* solution (see *Risk Assessment*)
- a dessert spoon
- 1000 cm³ salt water (a concentration of 30-35 g per litre - this should be made up first)
- a fine cloth and filter funnel
- a teat pipette, to catch brine shrimps from the main brine shrimp tank
- four 250 cm³ beakers
- substrate from the main tank.

Risk assessment



Teachers are reminded that a risk assessment is essential with the use of the herbicide *Simazine*, although there are few hazards with its use on this scale. *Simazine*, although algicidal at one part in a million and therefore posing a risk to the natural environment, is non-irritant and non-sensitising to the human skin at a strength **500 times greater** than that supplied to students in this investigation. **No case of human poisoning is known.** Goggles should be worn, however, but there is no need for gloves. The diluted herbicide should be administered by pipette dropper bottle by the teacher or by students under direct supervision.



The recommended dose (5 drops of 0.1% *Simazine* per 250 cm³ of salt water) will kill algae, but brine shrimps will tolerate up to 100 times this amount.

There is therefore no hazard to the shrimps or to the students at these recommended doses (strengths).

Disposal

It is suggested that you dispose of the liquid contents of the *Simazine* experimental container as follows. Filter off the shrimps. Wash them in salt water in a sieve and return them to their tank. Dilute the contents from the *Simazine* experimental containers ten times with tap water and pour it all down the drain. Alternatively, pour the diluted liquid on a weedy area of the school grounds. This will do no environmental harm.

Notes on procedure

In discussing pollutants it is important to note how powerful in effect some substances are, even at great dilution. Teachers and technicians must understand the dosage concentrations. For example, 0.001% (parts per hundred) is the same thing as 0.01ppt (parts per thousand) or 10 ppm (parts per million).

Liquid fertiliser may be added to the brine shrimp ecosystem well beyond the recommended dose and has little effect on the brine shrimps but **will affect the algae.** *Baby-Bio* contains nearly 10% urea but very little nitrate. The recommended dose for normal plant feeding is about 43 ppm urea (5 drops per pint per week), but this relies upon the ammonification of the urea and the nitrification of the ammonia in the soil. Brine shrimps will survive 50 drops per litre of *Baby-Bio* but the algae are harmed at this level.

Free nitrate, added as potassium nitrate, is readily taken up by algae and a rapid growth response occurs. 0.1 g/litre of potassium nitrate is equivalent to about 50 ppm nitrate. Over-addition of nitrogen may lead to anoxic conditions in which the levels of nitrite rise considerably. Brine shrimps will survive in high nitrite and nitrate levels, but do not reproduce and the toxic effects of these chemicals on the algae soon make the bottle substrate paler and not green in colour and microbially lifeless. Brine shrimps will not thrive if the algae decline. Dead shrimps 'disappear' quite quickly in well oxygenated water where there is active photosynthesis (to produce oxygen) going on. In nitrite rich waters, in which some shrimps still survive and in which the oxygen levels are extremely low, it may be so anoxic as to slow down shrimp decay. Such 'floating ghosts' are a sure sign of the collapse of the photosynthetic part of the ecosystem.

(See *Data Exercise 6* in Section 3 and the *Assessment Exemplar* in Section 6.)

ACTIVITY 12: The sun-seekers - let there be light

Aim and teaching objectives

This set of three experiments has been included because they are highly motivating to students. Procedural and observational skills are well tested and some subtle points about animal behaviour in response to environmental stimuli will emerge. They may be done as a small group or whole class experiment. They are well suited to a science club meeting and will provide real fascination on school open days, parents' evenings, etc..

Background

Brine shrimps show phototactic responses - they swim away from the dark towards bright light but will swim away from the most intense of lights. They will show an escape response if suddenly shadowed (as if by a predator).

Shrimps swim ventral side up normally. Shrimps do not seem to perceive 'up' from 'down' by gravity but by the direction from which the light comes. Thus they swim on their backs with their leafy-legs (phyllopodia) on the sunlit side. If light is not

coming from above they turn their ventral side to the direction from which the light comes. If the light is coming from below (easy to achieve on an overhead projector) they will therefore swim the opposite way up to normal. Brine shrimps swim ventral side up normally, so one must be careful not to confuse students when saying that they are swimming “upside down”. In one sense when swimming with light from below they turn the right way up!

Brine shrimps will seek out the shorter length radiation bluer end of the spectrum given a choice between red light and green. This is the wavelength with the greater usefulness for photosynthesis. It is interesting and undoubtedly adaptively significant that *Dunaliella*, the green alga upon which the brine shrimp principally feeds, also has the same spectral preference - swimming towards blue-green light.

Forward planning

The experiments require the use of one overhead projector for each student group. A circular glass trough or large crystallising dish is essential on each projector. A holding tank of brine shrimps with a good population is needed. Coloured acetate sheets of the type used for theatre lights are valuable. Try to choose acetates of equal colour density to make the spectral choice a fairer test. Coloured cellophane is almost as good.

Apparatus

- an overhead projector
- a circular or rectangular glass tank - the tank should be of a size that fits inside the glass top of the overhead projector
- salt water for the tank
- a dessert spoon (or wide-mouth pipette or sieve) to catch shrimps from the main tank
- 12-20 adult shrimps (with 2 or 3 students per group it is probably best to have only 12 shrimps in the dish; 16 or 20 could be included if there are 4-6 per group.)
- a 200 cm³ glass beaker
- a stop watch, or stop clock
- a sheet of acetate
- an overhead projector pen, preferably black
- a ruler
- at least two different colours of cellophane (or colour gels) - each of the two, or more, sheets needs to be about half the size of the glass top of the overhead projector
- a sheet of black card, or black paper, again about half the size of the glass OHP top
- a pair of scissors
- a bench lamp

- a thermometer (this is useful to check that the temperature of the water stays below 30° C).

Risk assessment



The electrical safety of having a tank of salt water on top of a piece of electrical equipment needs to be considered. Students must not do this investigation without very close supervision. In the unlikely event of any spillage, disconnect the electrical mains. Care in use of scissors is required.

Notes on procedure



The animals do not seem to be distressed at all by the bright light. Remember that the light will have a heating effect on the water and thus on the brine shrimps. They should not be exposed to temperatures higher than 30° C on the projector. This is unlikely to happen in a typical 1 hour lesson.

Experiment A

To see that phototaxis is uniform, this includes an initial control. The brine shrimps will predominantly seek the light in the shading experiment. To a shrimp in an open salt lake a shadow may indicate a predator. Certainly shadowing often produces an escape or turning behaviour response.

Experiment B

See *Background*, paragraph 2 page 64. The brightest light is likely to be a better environment for algal photosynthetic production.

Experiment C

See *Background*, paragraph 3 above. Bluey-green light is likely to be found in the brine shrimp's natural environment where incident light has come through algae in suspension. The blue wavelength is more active energetically in photosynthesis than red.

Extension

Only the most able and the most questioning of young minds will be looking beyond the fascination of doing this experiment to its meaning. A useful follow-up might be to ask directly just what the **survival advantages** of a brine shrimp's responses to light are. Some imaginative answers may appear.

ACTIVITY 13: Now go ponding - investigating the biology of 'water-fleas'

Aims and teaching objectives

The aim of this final practical unit is to promote active fieldwork on freshwater organisms, either as a class or individual homework exercise. The skills of disciplined and systematic pond-dipping are the teaching objectives. The sheets provide some information about crustaceans, specifically *Daphnia*, which is one genus with several species that will be most readily found in open ponds in summer. Any student who has followed some brine shrimp sessions in school should recognise the Crustacea now as a group. They will, of course, find other organisms when they get out there, especially insects such as water boatmen, whirligig beetles, pond-skaters, diving beetles, damselfly and dragonfly nymphs, not to mention molluscs, fish and amphibia.

Many of the skills learned in the course of brine shrimp studies will be transferable. A student's conceptual development about ecological relationships should be enhanced.

The full discipline of taking field notes should be encouraged now. This may be done into a notebook, but a hand held tape-recorder or even camcorder is a novel way of bringing information back to the classroom that students will find rewarding. Field data logging may be carried out too.

Background

Choose a pond with no fish if you want to find large numbers of Crustacea. Visit the site in advance. Don't over-work one site. Ditches and old brick pits are often rich. The water flea populations follow a boom and bust cycle like those of the brine shrimps, so there may be few around in early summer.

Forward planning

There is no substitute for a good school pond, though few of these will take the pressure of more than an occasional visit. Several plankton nets and stackable white trays will be needed. Laminated guides to pond life are invaluable, for example, the FSC guide (Orton. *et al.* 1995 General references, page 113).

Apparatus (for each group)

- a plankton net
- some white trays into which the catch from the net is put
- a screw top jar for bringing back samples to the lab.

- a notebook, to write down observations
- a set of pictures, or keys, of pond animals for the identification of different species (see resources list).

Risk assessment



Students should always be warned about the dangers inherent in a pond: slipping, falling in, stupid behaviour, etc.. **If the site is at all hazardous the teacher must be there.** Refer to school policy concerning out-of-classroom supervision.

If students are on their own they should be in at least groups of three and parental consent given. Teachers should know the hazard posed by Weil's disease (ref CLEAPSS publication PS1 *Pond dipping and Weil's disease*) and students should wear rubber gloves wherever possible and /or wash hands in soapy water when they return to the lab./home.

Notes on procedure

1. The students might be directed in small groups at a time to a local pond or ditch source, or a party taken out of school to a more distant site. Students need to be taught the use of a plankton net and in particular the way in which sampling may be standardised and the organisms tipped out into trays for examination. It would make good sense to bring back some crustaceans from the wild to the lab. (This is certainly not be encouraged for other species such as amphibia, but the captured crustaceans might be kept for a study week **before returning them to the wild**).
2. After the initial excitement of reaching the site it is important that students observe and record before they start to pose questions. So much work of a quantitative kind has been done in previous brine shrimp units that producing some quantitative data might now be easier to contemplate, more easy to apply and more easy to work from, to produce a valid general conclusion.

Section 3

Secondary data exercises

TEACHER'S GUIDE

Aims and teaching objectives

These are data based exercises on brine shrimps. The aim of these seven data sheets is to provide extension opportunity for students.

They may help them to:

	Data sheets
• research further from other sources	1,2
• use tabulated data for graphical construction	5,7
• read data straight from a graph	3,4,6
• use a table to discover new information	2,3,7
• use a graph to discover new information	2,3,4,6
• use several sources of data to find one unifying conclusion	2,3,6
• formulate hypotheses from data	1,2,3,4,5,6
• evaluate experimental design	6,7
• discover important biological concepts	1,2,4,6
• write imaginatively from their learning	1,5,6,7

The data sheets

All the data are based on **actual research** with these animals. The level of questions (levels 5-8) is directed towards KS4, but able students at KS3 should gain much from the data analysis in each data sheet.

In some cases, the sheets are more appropriate as extensions from the investigations.

	Investigations
1. Brine shrimps all around the world	(3, 6)
2. Salt and survival - the cost of living in a very salty place	(3, 7)
3. Temperature effects - too hot, too cold	(3, 6, 9, 12)
4. The daily cycle of chemical change	(5, 6)
5. The brine shrimp sex balance	(6, 7)
6. Copper - contamination and pollution	(6, 11, 13)
7. Brine shrimps in space - Apollo 16	(3, 6, 11)

Guide answers to the questions are given on pages 79-81.

1: BRINE SHRIMPS ALL AROUND THE WORLD

Study the map of the places where brine shrimps are naturally found.

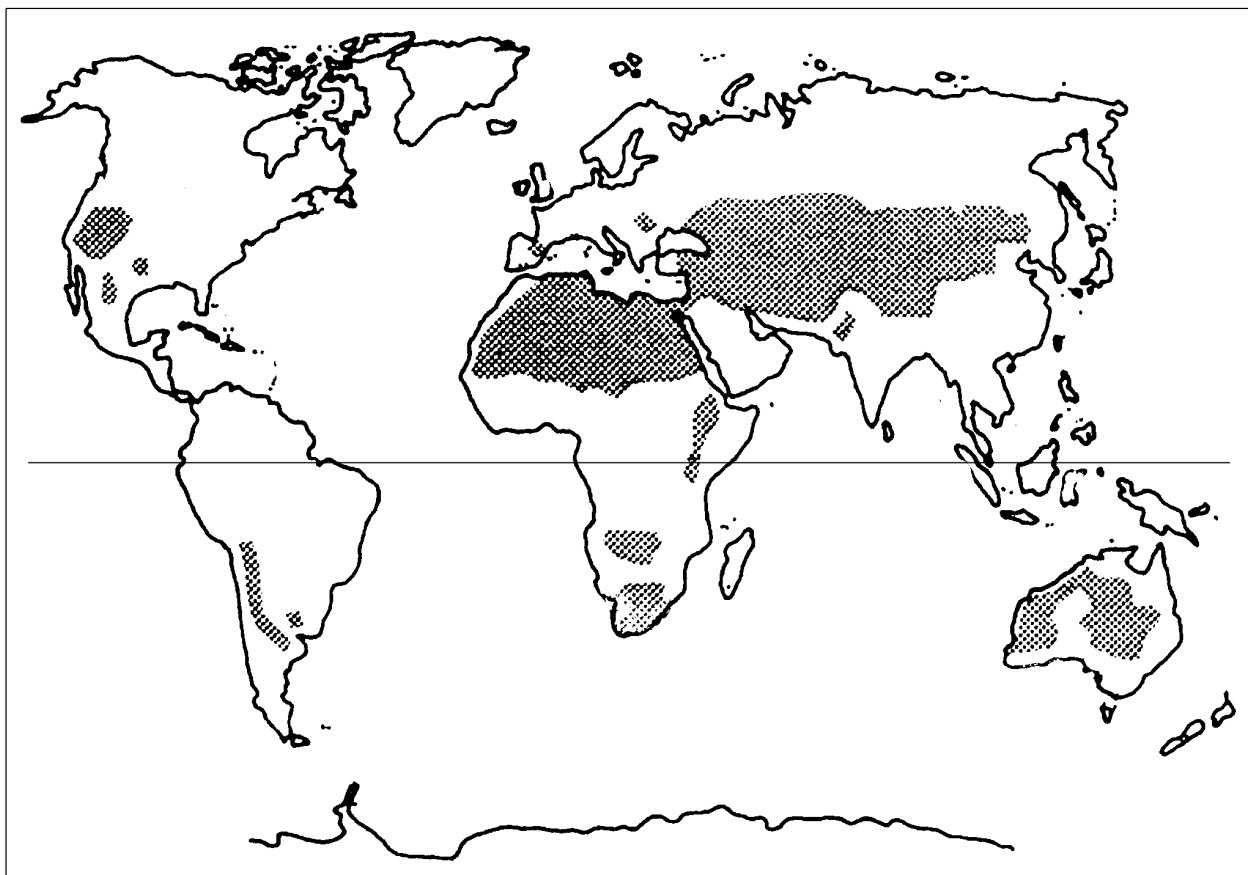

Questions

1. Look at the shaded areas of the continents. Find out from a Geography book, atlas or the internet about the rainfall and temperature of any of these places. When does it rain, how much does it rain and how hot does the temperature get compared to Britain?
2. The sea has a fairly constant saltiness, but why are brine shrimp lakes often so variable in salinity?
3. Salt lakes all have rivers going in to them but none come out! The water evaporates and leaves the salt, so where must the salt originally come from?
4. Write down any reasons why a salt lake might be different from the sea in the **kind** of salt that it has.
5. In Cheshire (England) there are salt mines from which household salt for cooking comes. Suggest how millions of years ago this rock deposit might have been formed.

2: SALT AND SURVIVAL - the cost of living in a very salty place

Brine shrimps prefer about 35 grams of salt per litre (this is 3.5 grams in 100 grams of water and so is described as 3.5% salt). We might expect salt above or below 3.5% to be less suitable for brine shrimps.

Shrimps are great survivors. Sometimes their environment gets very salty indeed and ecologists have even seen brine shrimps swimming in saturated salt solutions where salt crystals are forming in the water!

Just how salty can this environment be before the shrimps begin to survive less well?

An ecologist made up tanks of salt varying from 6% to 18% salt and grew brine shrimps in them.

- Graph 1 shows the survival of 100 newly hatched shrimps at four increasing levels of saltiness.
- Graph 2 shows the mean increase in length of young shrimps under the same conditions.

Graph 1

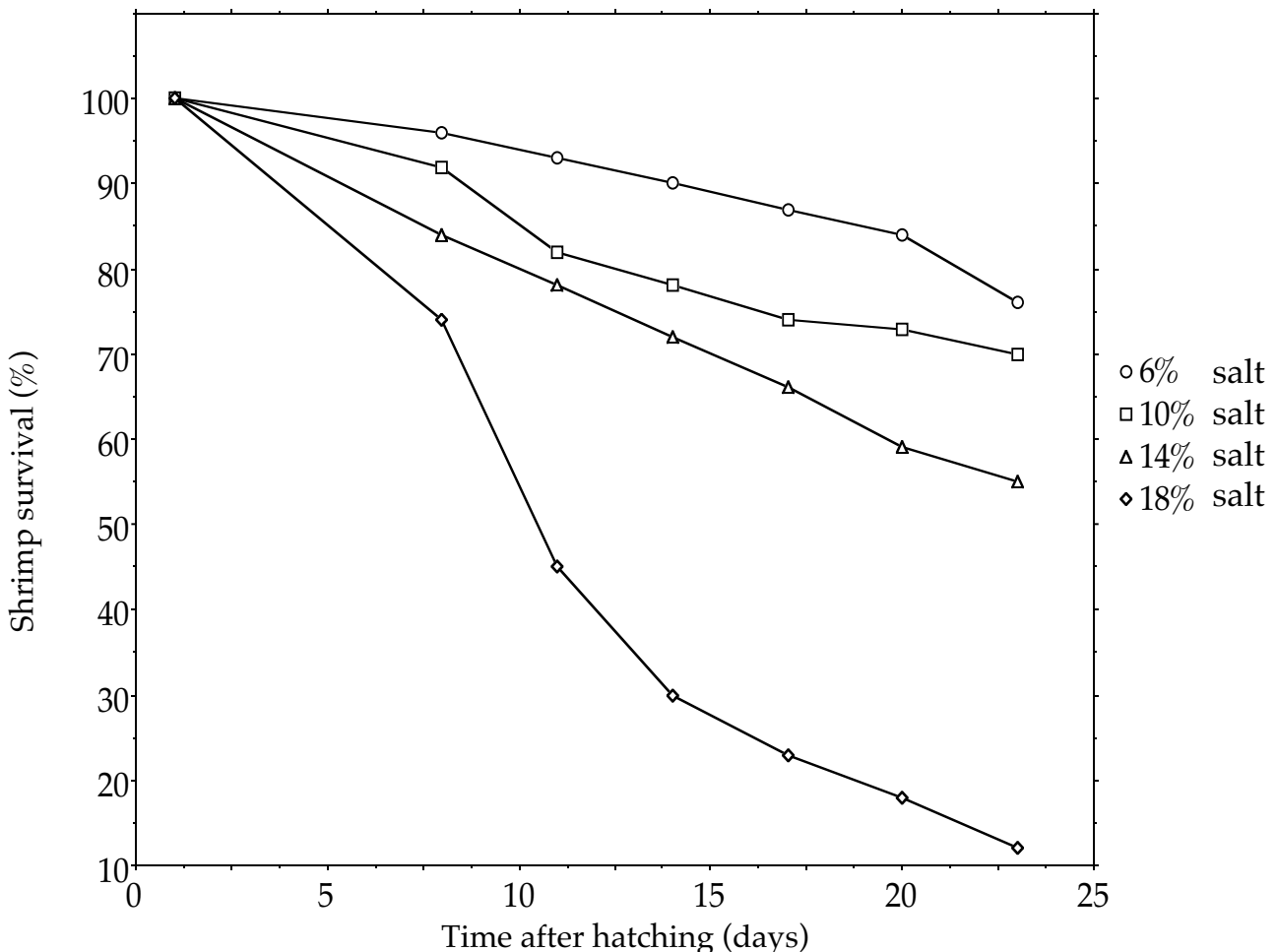

Graph 2

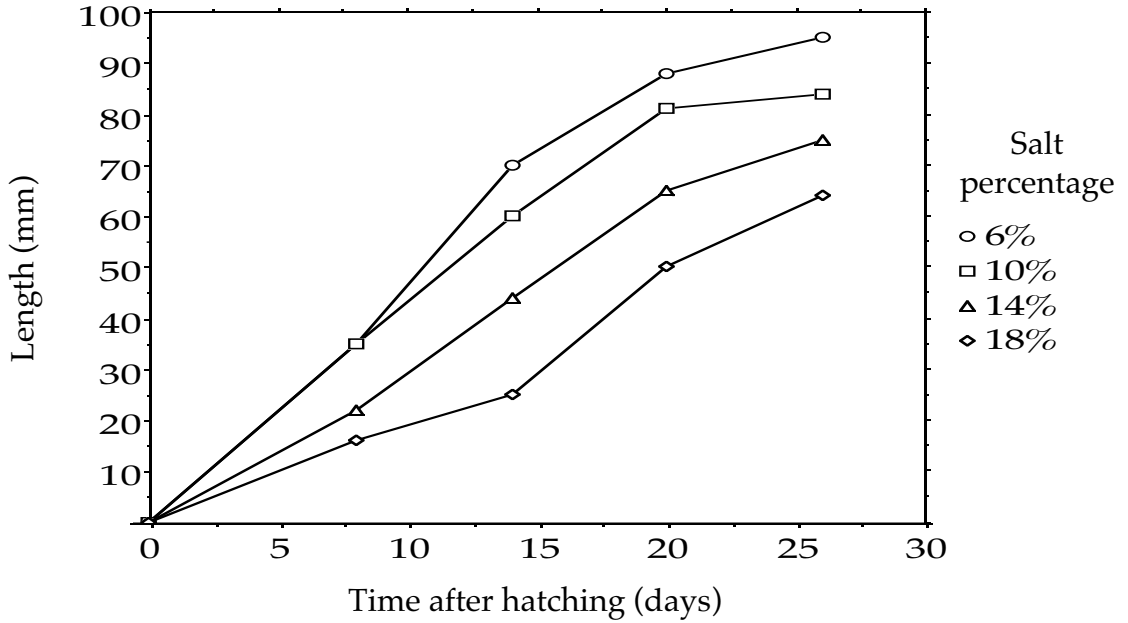

In another investigation Gayle Dana, an American ecologist, studied the effect of high salt percentages on the reproductive success of female brine shrimps.

	Salt percentage			
	6%	10%	14%	18%
The age at which the female released her first brood of eggs	40 days	42 days	58 days	75 days
The percentage of females with eggs in their brood pouches	96%	87%	77%	10%
The average number of eggs in the brood pouch of any females that had eggs	40 eggs	37 eggs	25 eggs	20 eggs

Questions

1. What is the effect of higher and higher salt concentrations on shrimp survival?
2. What is the effect of higher salt concentration on shrimp growth?
3. Discuss the effects of higher salt concentration on brine shrimp mothers.
4. Read in a biology text book about **osmosis**. In stronger and stronger salt solutions there is obviously increasing salt but also there is less and less water! Might this be important in the life of a shrimp? The blood of a shrimp is only about 2% salt in water. In a very salty environment, what effect do you think osmosis will have on the blood of shrimps?
5. Brine shrimps cannot help but take in much salty water as they feed and have to pump the salt out of salt glands on their legs! This takes a lot of energy. Make a hypothesis to explain why shrimps do less well in very salty environments.

3: TEMPERATURE EFFECTS - too hot, too cold

All animals are affected by the temperature of their environment. We may learn about the temperature an animal prefers by looking at how it behaves and even how its survival is affected by different temperatures.

Experiment 1

The graph below shows an experiment on the activity of two groups of brine shrimps at different temperatures (data from Simon 1983). The brine shrimps were allowed to settle for an hour at 20° C. During this time their normal level of activity was measured. This is shown on the vertical axis as 100% activity.

- For one group the temperature was raised to 30° C for two hours (60 to 180 minutes) and then cooled down again to 20° C (see the top line).
- For the other group the temperature was lowered to 10°, for two hours (60 to 180 minutes) and then warmed up again to 20° C (see the bottom line).

Brine shrimp activity at 30° C and at 10° C.

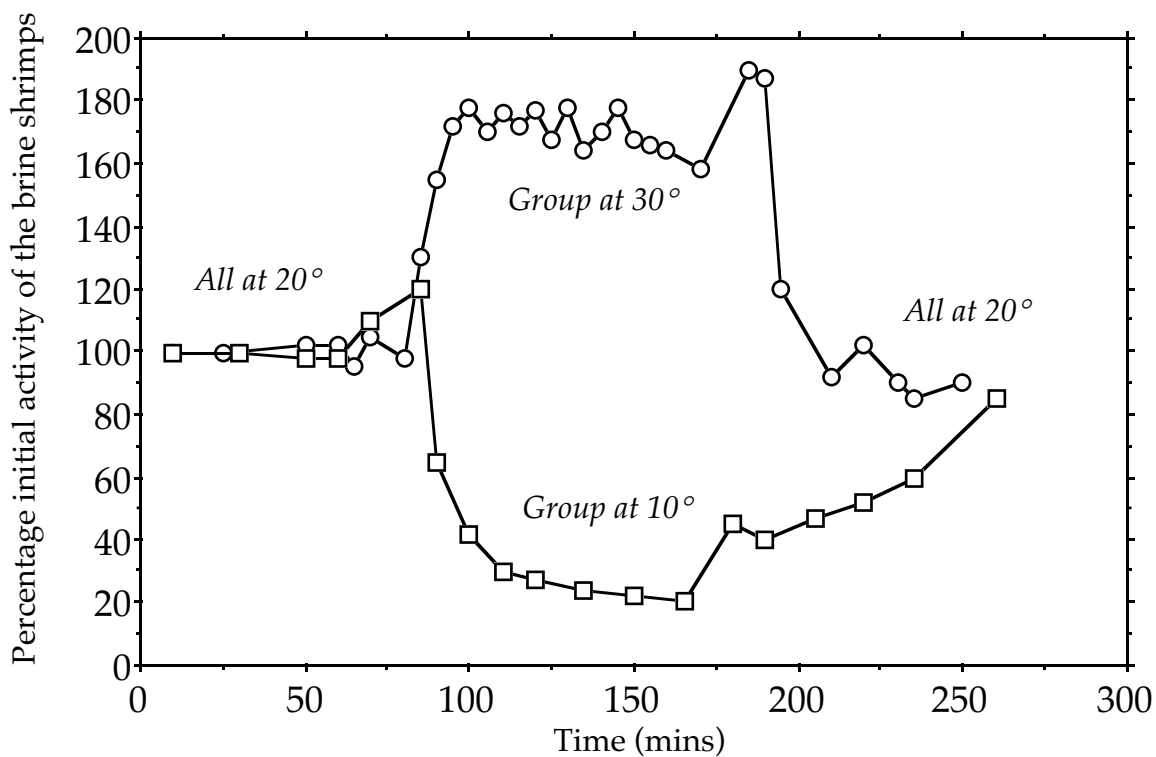

The activity of the shrimps was measured at five other temperatures besides 10° and 30° C. These results are in the table below.

	5°C	10°C	15°C	20°C	25°C	30°C	35°C
Average percentage activity	12%	30%	75%	100%	150%	170%	190%

Experiment 2

In a different experiment a long trough of water was arranged so that the shrimps could swim up and down. At one end of the trough the temperature was close to freezing and at the other end it was very warm (Eziefula 1997). The shrimps could swim to and fro and so choose the temperature they preferred.

Eziefula's experiment	5°C	10°C	15°C	20°C	25°C	30°C	35°C
The percentage of shrimps choosing to swim at this temperature	4%	1%	2%	13%	67%	13%	0%

Experiment 3

Another investigation was carried out to discover the effect of temperature on the shrimps' hatching success and survival at a range of different temperatures.

The graph on the right shows:

- the percentage of shrimps hatching at different temperatures (lower line)
- the percentage of shrimps surviving to adult age after hatching at each of these different temperatures (top line).

After hatching all shrimps were put in salt water at a constant 25° C (data from Triantaphyllidis 1994).

The effects of temperature on hatching and survival

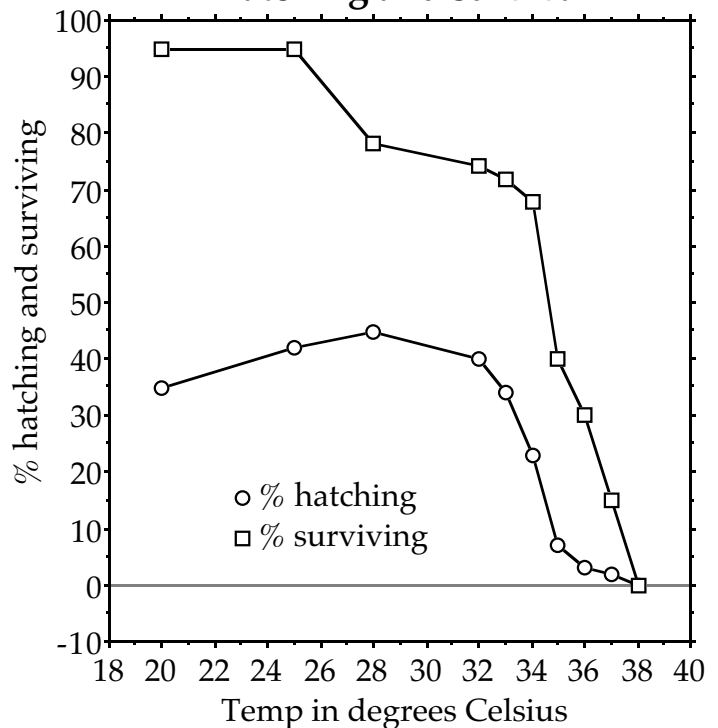

Questions

1. What does Experiment 1 tell you about the effect of temperature on the activity of brine shrimps?
2. What do the shrimp's choices in Experiment 2 tell you?
3. In the first experiment, Simon discovered that when the shrimps swim into a cold place they become less active. In the second experiment some of the animals seemed to prefer the very coldest end of the trough into which they had swum. Make a hypothesis to explain why this might have happened.
4. At what temperatures did the brine shrimps hatch best in Experiment 3 and what was the hatching temperature with greatest % survival after hatching?
5. A scientist looked at this graph and stated that "Brine shrimps do best when hatched at 25° C as at this temperature the greatest number of egg cysts will become adult brine shrimps". Do you agree with this deduction? If you do, explain why.

4: THE DAILY CYCLE OF CHEMICAL CHANGE

Brine shrimps and the algae in their ecosystem affect the chemical balance of the water they are in.

Using a bottle ecosystem with two recording probes set in it, together with a data logger and a computer, the changes in the pH and the dissolved oxygen levels may easily be measured. The graph below is from one bottle ecosystem data-logged for these two variables over 24 hours. Time 0 is at midnight. The first sunlight reached the bottle at 6 hours and the sun finally went down at 18 hours. There were a large number of shrimps in the bottle and a rich algal community.

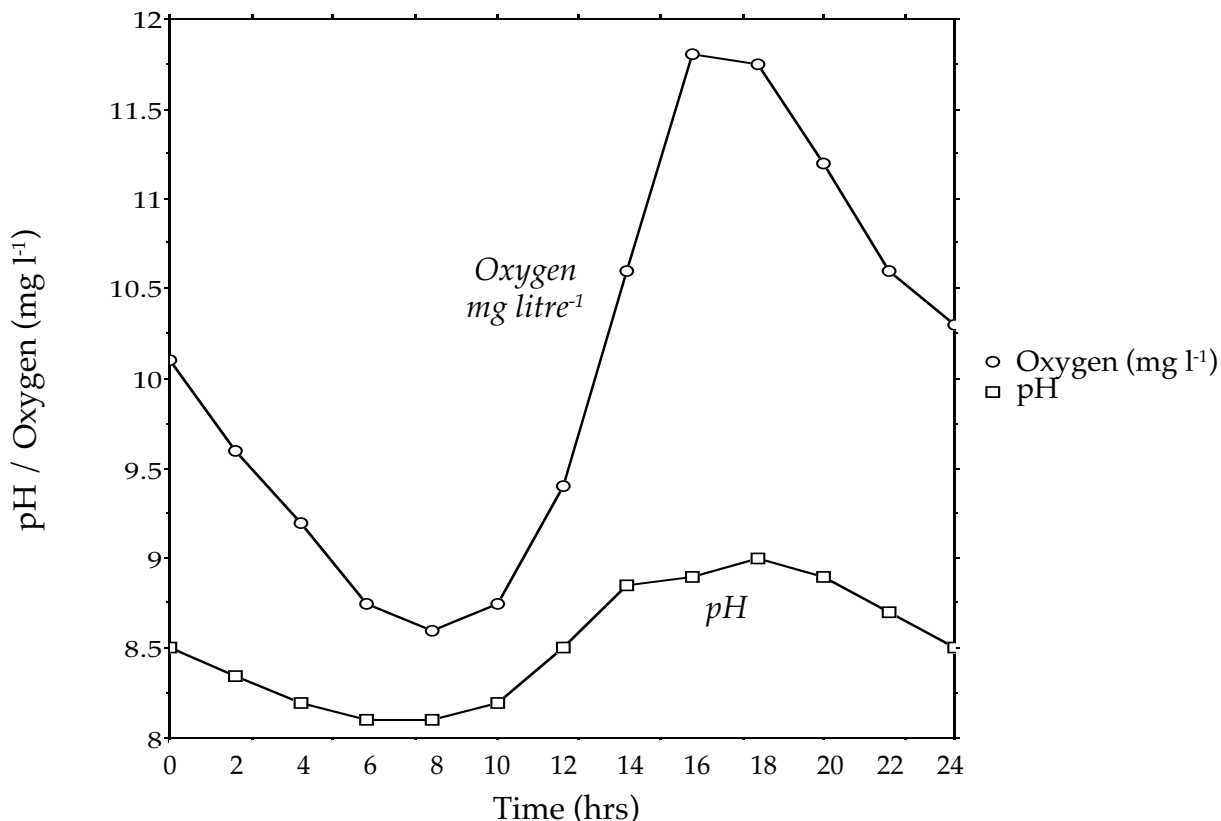

Questions

1. Mark on the graph with two vertical lines the time of dawn and dusk (see above) and so the hours of daylight in between.
2. What happened to the oxygen level during the day? From your knowledge of green algae in the light explain why you think that this change was occurring.
3. At night the oxygen level fell steadily. Explain why this might have happened.
4. What does pH measure?
5. What acid gas do all living things give out when they respire and breathe?
6. What happened to the pH at night? Can you explain why this happened.
7. Make a hypothesis relating to the green algae to explain the change in pH during the day.
8. With respect to the two respiratory gases, oxygen and carbon dioxide, what does this graph tell you about the relative rates of respiration and photosynthesis that are going on around (i) midnight (ii) midday (iii) dawn and (iv) dusk?

5: THE BRINE SHRIMP SEX BALANCE

Humans have a very balanced **sex ratio**: numbers of human males and females are almost equal. This is not always so for other animals for there may be an advantage to a species in sometimes having more of one sex than the other. Are the brine shrimp sexes always balanced?

The table below is of data that were collected by Orlando Cuellar from the southern part of Lake Utah. He recorded the sexes of the brine shrimps in a random sample of about a thousand captured animals. He visited the lake in three different years and sampled in every month except December to March.

Date	Day of year	Number of Males	% Males	Number of Females	% Females
15 September 1978	257	710	57	541	43
29 September 1978	272	668	63	393	37
13 October 1978	286	667	66	340	34
27 October 1978	300	700	65	375	35
11 November 1978	314	783	77	240	23
15 April 1979	95	0	-	0	-
6 May 1979	121	nauplii	-	nauplii	-
1 May 1979	138	525	48	568	52
18 July 1979	205	339	34	646	66
24 August 1979	227	388	38	628	62
15 August 1979	233	584	51	562	49
21 September 1979	264	510	51	491	49
21 October 1979	285	518	52	482	48
16 November 1979	320	0	-	0	-
15 June 1981	166	628	52	587	48
30 June 1981	181	541	48	583	52
15 July 1981	196	447	41	632	59
15 August 1981	227	485	47	550	53

Questions

1. What did Orlando Cuellar find when he collected in April 1979 and in late November 1979? Why do you think he did not bother with collecting in December, January or February?
2. Why did he record the sexes of about 1000 animals to get his percentage and not only count just a hundred?
3. Draw the axes of a large graph with the **days of the year** (from day 0 - day 365) along the x axis and **percentage shrimps** (from 0%-100%) on the vertical y axis. Write the months along the bottom. Make a scatter diagram of the **% males** combining the data from all years. Make a line of best fit through the dots. Next make a scatter diagram of the **% females** combining the data from all years. Make a second line of best fit through these dots.
What do your scatter diagrams reveal?
4. Make a hypothesis to explain the change in **sex ratio** over the summer months.

6: COPPER - contamination and pollution

Copper ions (which cause the blue colour in copper salt solutions) are present in tiny amounts everywhere in the environment. Both humans and brine shrimps need some copper to be healthy. But too much copper is very poisonous and where there is too much in the environment copper may be a killer.

In an investigation of pollution by copper ion, some brine shrimps were taken from an unpolluted environment and their uptake of the poisonous copper ion was measured by experiment. Two sets of results are shown.

The first graph shows the amount of copper taken up by shrimps over a range of conditions of acidity and alkalinity (pH). The units are very small, being billionths of a mol. of copper per gram of shrimp per minute!

Graph 1

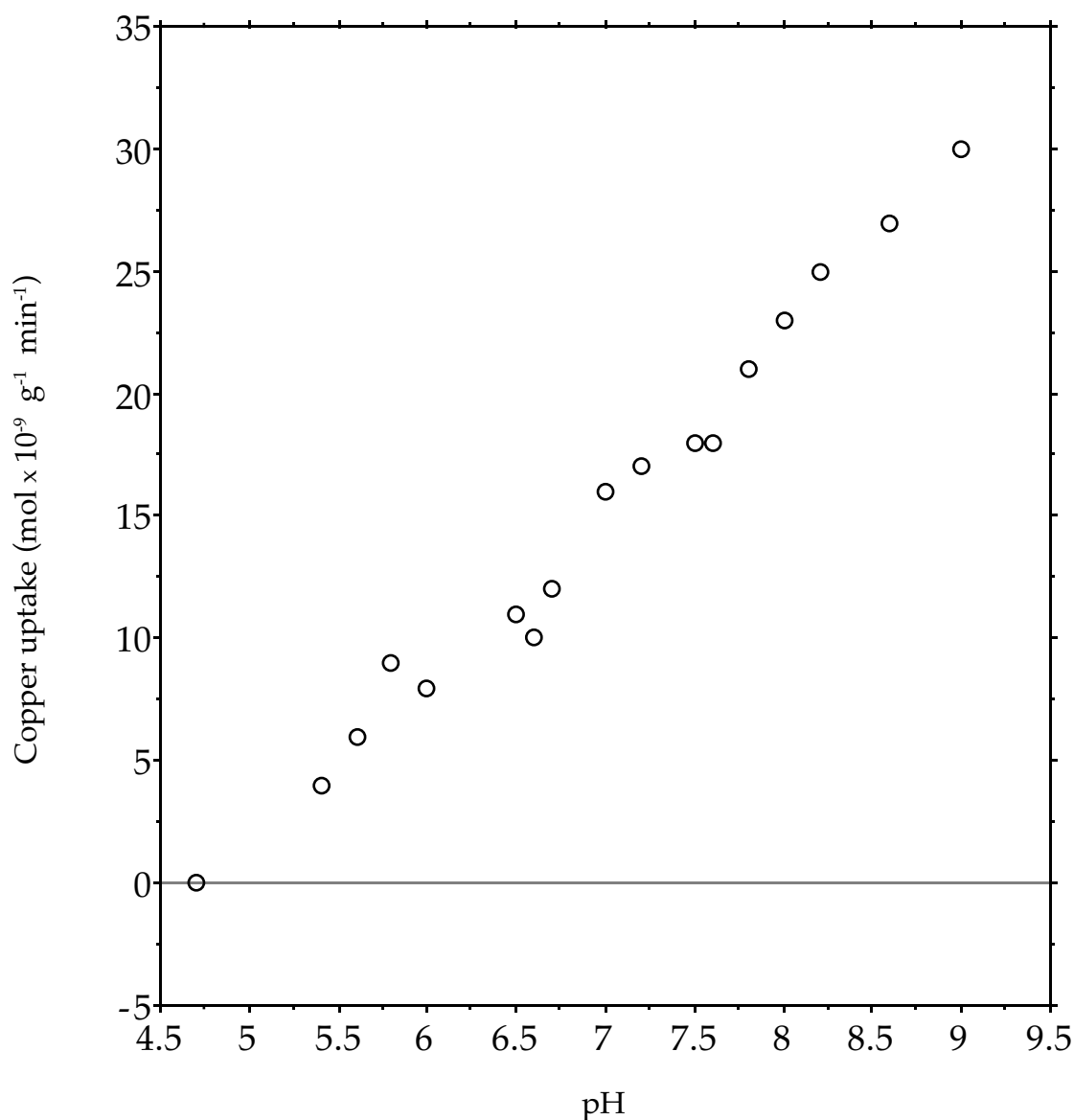

The second graph shows the rate at which copper accumulates in brine shrimps in copper polluted waters. The gut and the other body parts were separately analysed for the copper ions.

Graph 2

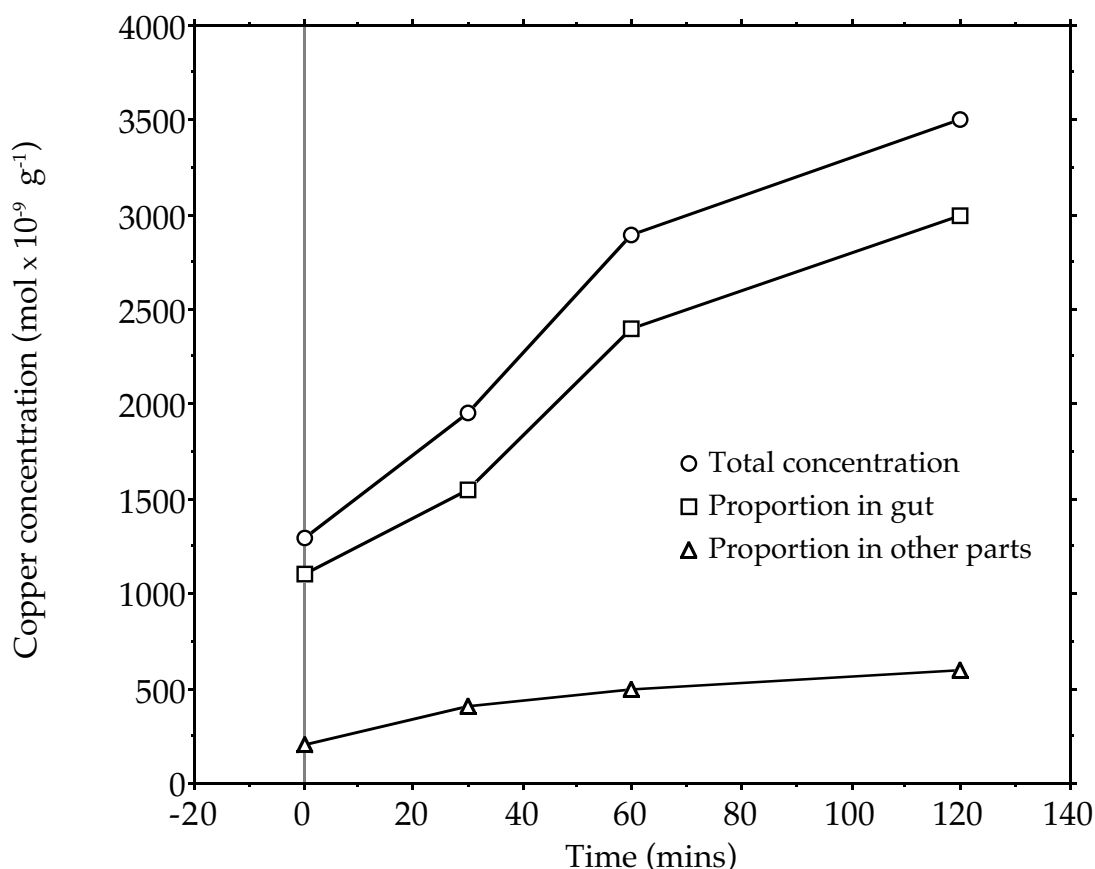

Copper ion is a large particle and does not easily diffuse into an animal's body. How does the copper enter? One suggestion is that shrimps filter feed and accumulate the copper from the food they eat.

Questions

1. From the first scatter diagram, say how the pH of the water affects the uptake of copper ions by the shrimps.
2. If there is copper polluting the water and a brine shrimp could choose between a neutral, acid or alkaline salt lake what would be its best and worst choice?
3. How does the second graph support the hypothesis that copper enters the shrimps' bodies with the food they eat?
4. In an investigation of the effect of copper ion on shrimps it was found that they were not poisoned if they were only in the polluted water for a few minutes, but after two days the animals had all died. Suggest why this is.
5. One pollution scientist said, "the harm from pollution is equivalent to dose times exposure". What did she mean?
6. There are many hazards in our environment, such as insecticide sprays, cigarette smoke, or ultra violet radiation. How do you control your own 'dose' and 'exposure' to any known environmental hazard?

7: BRINE SHRIMPS IN SPACE - Apollo 16

It is interesting to think about a bottle ecosystem surviving in space! The Earth is a much safer place for life than space. But brine shrimps have in fact been travelling in space for many years, having flown on some of the Apollo and Soyuz space missions, on the NASA space shuttle and recently on the Mir station.

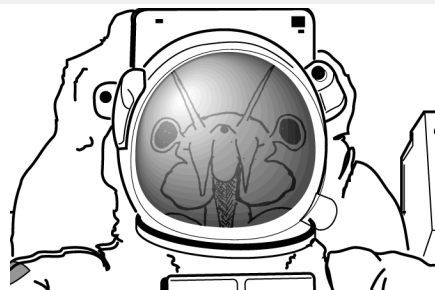

As there are **radiation hazards** in space, scientists are interested in how well shrimp eggs survive after a space journey. When brine shrimp egg cysts travelled on Apollo 16 they went round the moon and back! On the journey brine shrimp eggs were packed between layers of photographic film and placed in small black plastic boxes. If a **cosmic ray** (a kind of damaging radiation) passed through an egg this would be detected on the photographic film. In one experiment, some eggs were kept on Earth as 'controls' to ensure a fair test. These were packed in just the same way. Also, as the journey up in a rocket involves a lot of shaking and acceleration, one control group of egg cysts was accelerated to seven times the force of gravity and vibrated mechanically from side to side for several minutes so that they could experience the violence of a rocket take-off! (Planel *et al.* 1980).

When the brine shrimp egg cysts returned safely to Earth, the photographic film was carefully analysed to see if they had been hit by cosmic rays. The egg cysts that had been in space were divided into 'hit' and 'non-hit' eggs. The control groups of egg cysts left on Earth were unpacked in exactly the same way. None of these had been hit by cosmic rays. There were 400 eggs in each experimental group. All the egg cysts from the experiment were then placed in salt water to hatch under optimum conditions.

It was then recorded:-

- whether the egg cysts opened in the water (EMERGENCE)
- whether the larvae came out successfully and swam away (HATCHED)
- whether the nauplii were swimming at four days old (SWIMMING NAUPLII).

Study the table of results from Apollo 16 below:

	Earth controls (n=400)	Accelerated and vibrated Earth controls (n=400)	Experimental egg- cysts in flight not 'hit' by cosmic rays (n=400)	Experimental egg- cysts in flight but 'hit' by cosmic rays (n=400)
% emergence	66	57	30	10
% hatched	61	49	25	7
% swimming nauplii	60	48	22	5

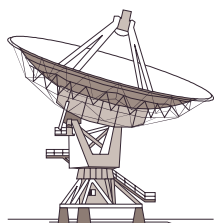

1. Present these results as a bar chart.
2. Write a report for the *National Space and Aeronautics Administration* (NASA) on your conclusions, explaining your control experiments very carefully.

ANSWERS TO DATA EXERCISES

Data sheet 1

Brine shrimps all around the world

This is a library search extension exercise.

Notes and answers to the questions

1. The subtropics generally have late winter/spring rains and long, very hot, dry summers.
2. Variable salinity is a feature of these environments (as opposed to the relative constancy of salt in sea water). Salinity in a salt lake is governed by precipitation and evaporation.
3. Salt is leached out of soils and from native rocks.
4. Some salt lakes are high in sodium carbonate (soda lakes), some have very high levels of particular mineral ions.
5. Rock salt deposits are thought to be mineralogical traps of salt from dried up seas or salt lakes. The Cheshire salt deposits were laid down under desert conditions.

Data sheet 2

Salt and survival

Using graphical and tabulated data to draw conclusions.

Notes and answers to the questions

1. The stronger the salt the less well they survive.
2. The stronger the salt the more slowly they grow.
3. The stronger the salt the longer it takes for females to breed, fewer females are able to produce eggs and the number of eggs that they have is less.
4. Strong salt solution will draw water out of the shrimps by osmosis.
5. Shrimps have to spend energy on dealing with the high levels of salt in the water (pumping ions out) and have less food resources for growth and reproduction, etc..

Data sheet 3

Temperature effects

This unit provides an opportunity for graphical and tabulated data interpretation, as well as computation from the data presented.

Notes and answers to the questions

1. Brine shrimps change their activity level soon after a temperature change. They are less active at lower temperatures (10° C) and more active at higher temperatures (30° C).
2. In the second experiment (Eziefula's experiment) the shrimps prefer 25° C.
3. Warm active shrimps that do swim into the cold cool down and are not active enough to get out again.
4. The shrimps hatch best at 28° C. The greatest percentage surviving were at 20-25° C.
5. 25° C is the best answer as, although the hatching success is lower than at 28° C, the survival is higher.

at 20° C, 35% of 95% = 33%

at 25° C, 41% of 95% = 39% * best answer

at 28° C, 45% of 78% = 35%

Data sheet 4

The daily cycle of chemical change

This unit provides opportunity for graphical data interpretation, as well as a chance to reason out an important ecological balance of the respiratory gases.

Notes and answers to the questions

1. Daylight is from 6 hrs to 18 hrs.
2. Oxygen levels rise on account of algal photosynthesis.
3. Oxygen is used up by respiring shrimps and algae.
4. Acidity and alkalinity.
5. Carbon dioxide.
6. It went down as the amount of acid carbon dioxide increased.
7. During the day the pH went up again due to the use of carbon dioxide by the photosynthesising algae.
8. (i) At midnight all the living things are respiring but there is no photosynthesis;
(ii) at midday all the living things are respiring but the green plants are photosynthesising at a high rate resulting in a net increase in oxygen and net fall in carbon dioxide;
(iii) at dawn and dusk, the dim light levels make the rate of photosynthesis balance out the rate of respiration (they compensate for each other) so that for this short time there is no net gaseous level change.

Data sheet 5

The brine shrimp sex balance

This exercise illustrates several points about sampling and data analysis. Good sample sizes are needed for confidence in data. The scatter diagram shows the value of combining data to find a trend which may not be immediately apparent.

Notes and answers to the questions

1. The assumption is made that the shrimps would not be present in the winter months.
2. A sample size of 1000 will give a more representative percentage.
3. The scatter diagram will show that the sex ratio is roughly equal until late July, when the males decline relatively and the females increase in proportion. The balance equalises again in September but after September the opposite is true, the males become greater in proportion in the autumn and the females less (see opposite page).
4. There are two obvious possibilities. There may be a bias in the second generation hatching out, the individuals being more likely to be female (or even parthenogenetic). Males may survive less well in the hotter months (there seems to be a differential mortality in the autumn, the females dying earlier than the males). The sex ratio at any time is likely to reflect selection acting on individuals to maximise their reproductive success.

Data sheet 6

Copper ion as a pollutant

The definition of a pollutant is that it is a substance which, in sufficient quantities, upsets the balance of an ecosystem and causes harm to the organisms within it. The idea that the harm is due to **both dose and exposure** emerges from this unit. Many 'pollutants' do not cause measurable harm because they are diluted below the level where they have any obvious effect or, although present in sufficient concentration to cause harm eventually, they may not do so because they are present for too short a time.

Notes and answers to the questions

1. As alkalinity increases so too does copper ion absorption.
2. Acid would be the best (least harmful) and alkaline the worst (most harmful) choice.
3. There is more copper in the gut than anywhere else.
4. Brine shrimps will accumulate the copper if it is present in their environment.
5. Harm done is proportional to how much of the pollutant is there and for how long its effect lasts.
6. Students may explore any of these areas and relate dose-exposure factors to their own lives. A good example is smoking cigarettes! Another good example is managing exposure to the sun's UV rays so that sunburn is avoided.

Data sheet 7

Brine shrimps in space

This is a challenging exercise in data evaluation with the added opportunity for some imaginative reporting.

Notes and answers to the questions

1. There will be twelve bars, but the bar chart may be presented as either three groups of four bars or, with equal validity, four groups of three bars. Either way the picture should be clear. Life in space is tougher than life on Earth!
2. The report should make the following points. There is a natural failure rate anyhow in emergence, hatching and survival to four days. Against this control physical exposure to the 'take-off' experience does have some measurable negative effect. But even if this is taken into account, egg cysts that are **not hit** by the gamma rays in space do seem to suffer some harm, as they develop half as well as the ones that had a simulated space journey. Cosmic rays are certainly additionally harmful. Arguably almost all 'hit' egg cysts do not develop well. Students might well make extrapolations as to the need for NASA to provide space suits for humans that resist the penetration of cosmic rays.

Scatter diagram for Data sheet 5

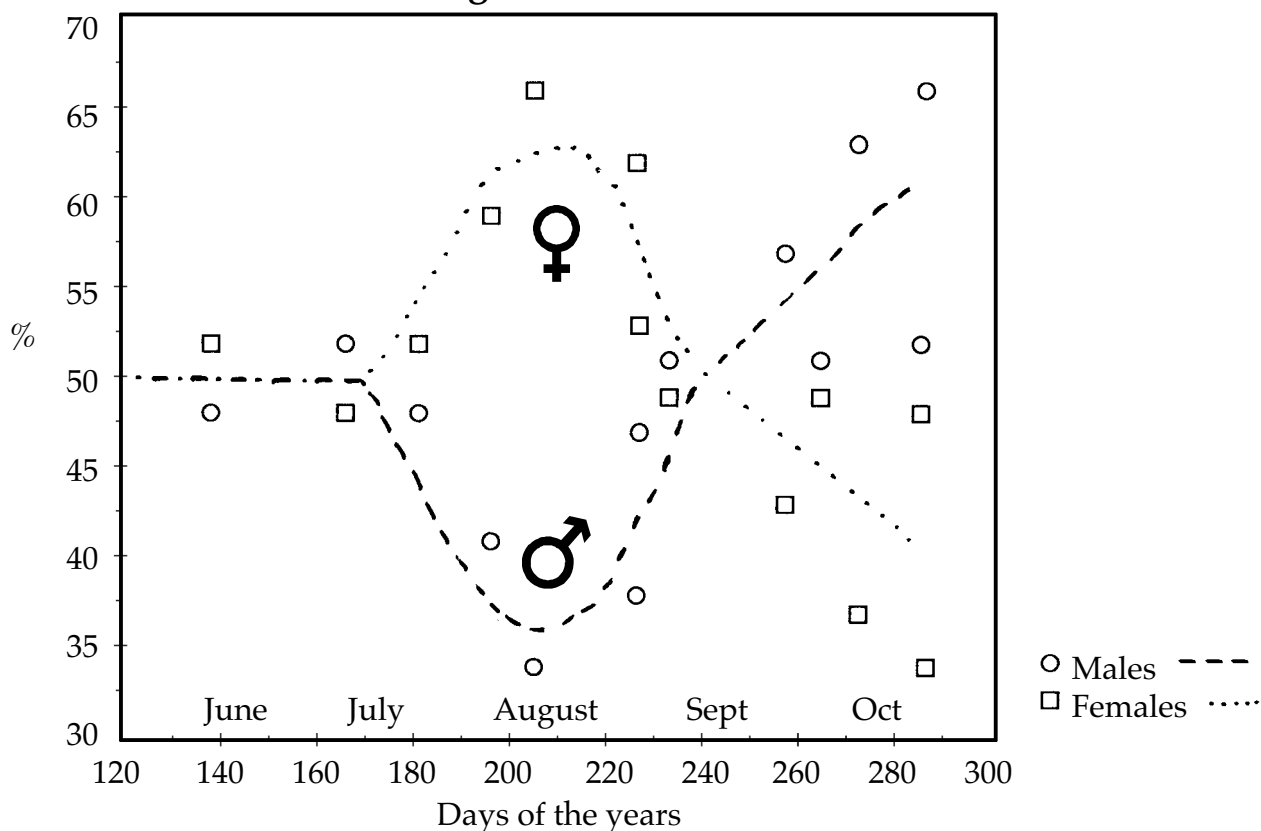

Section 4

Illustrations for photocopying

DRAWINGS OF BRINE SHRIMPS

The drawings

Refer to the labelled drawings on *Student Activity Sheet 1* (page 8) for the names of parts. The drawings which follow may be used by pupils for labelling or constructing their own life cycle and food web diagrams.

Adult male brine shrimp (*Artemia franciscana*). Note the large clasping antennae.

Adult female brine shrimp (*Artemia franciscana*). Note the brood-pouch.

Adult male brine shrimp mate-guarding a female. The female is clasped by the male, using the base of the antenna.

Embryonic stages prior to hatching and the hatching of the nauplius larva.

Growth stages of the brine shrimp (*Artemia franciscana*).

Organisms in the brine shrimp food web: algae; brine shrimps; avocet and greater flamingo; eagle.

The bottle ecosystem.

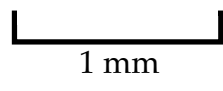
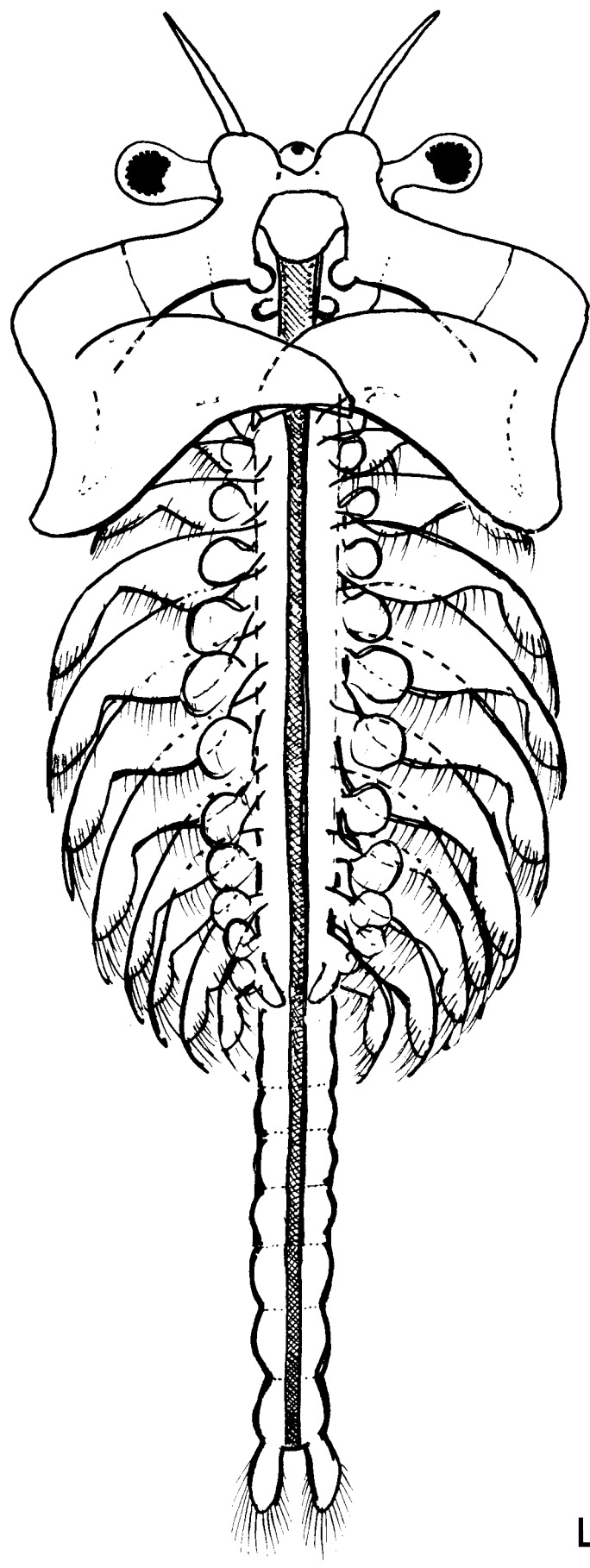

Adult male brine shrimp
Artemia franciscana

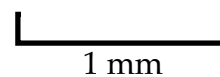
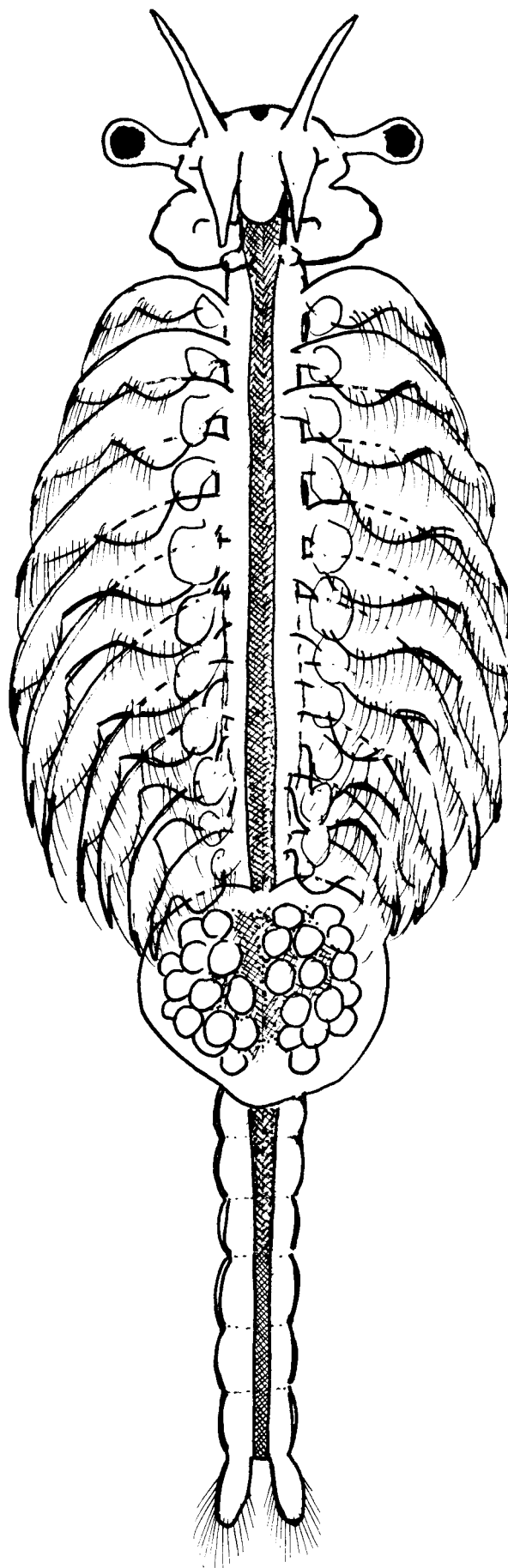

Adult female brine shrimp
Artemia franciscana

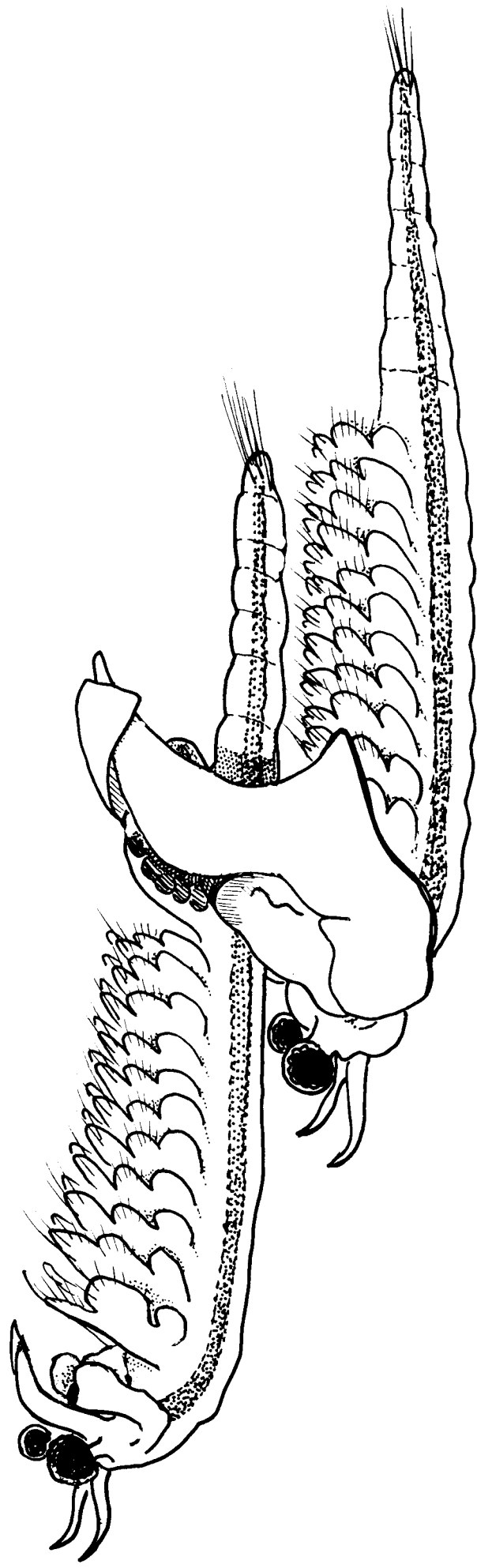

1 mm

Adult male and female brine shrimp
Mate-guarding

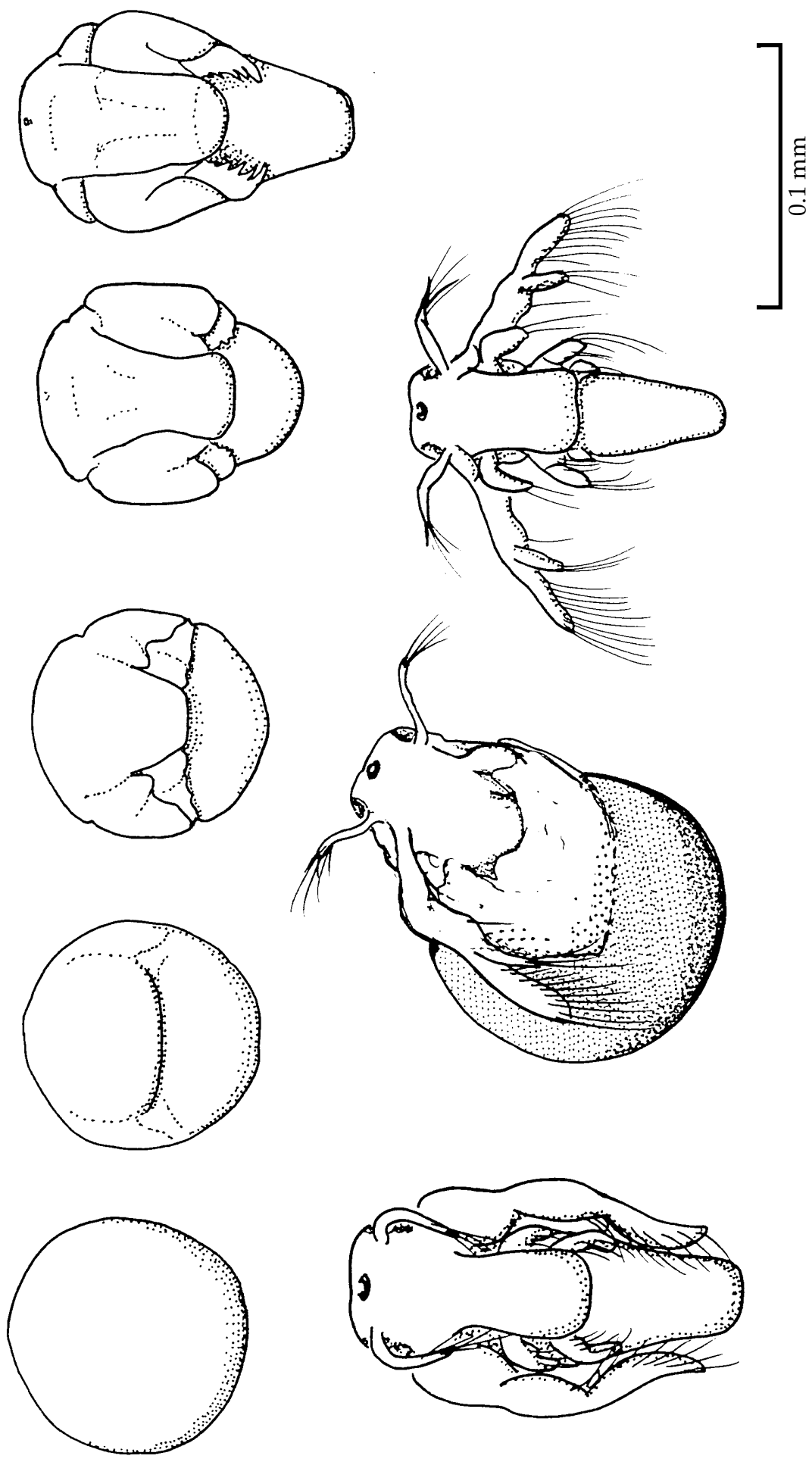

Top row: Embryonic stages, inside the egg cysts, prior to hatching
Bottom row: The nauplius larva before, during and after hatching

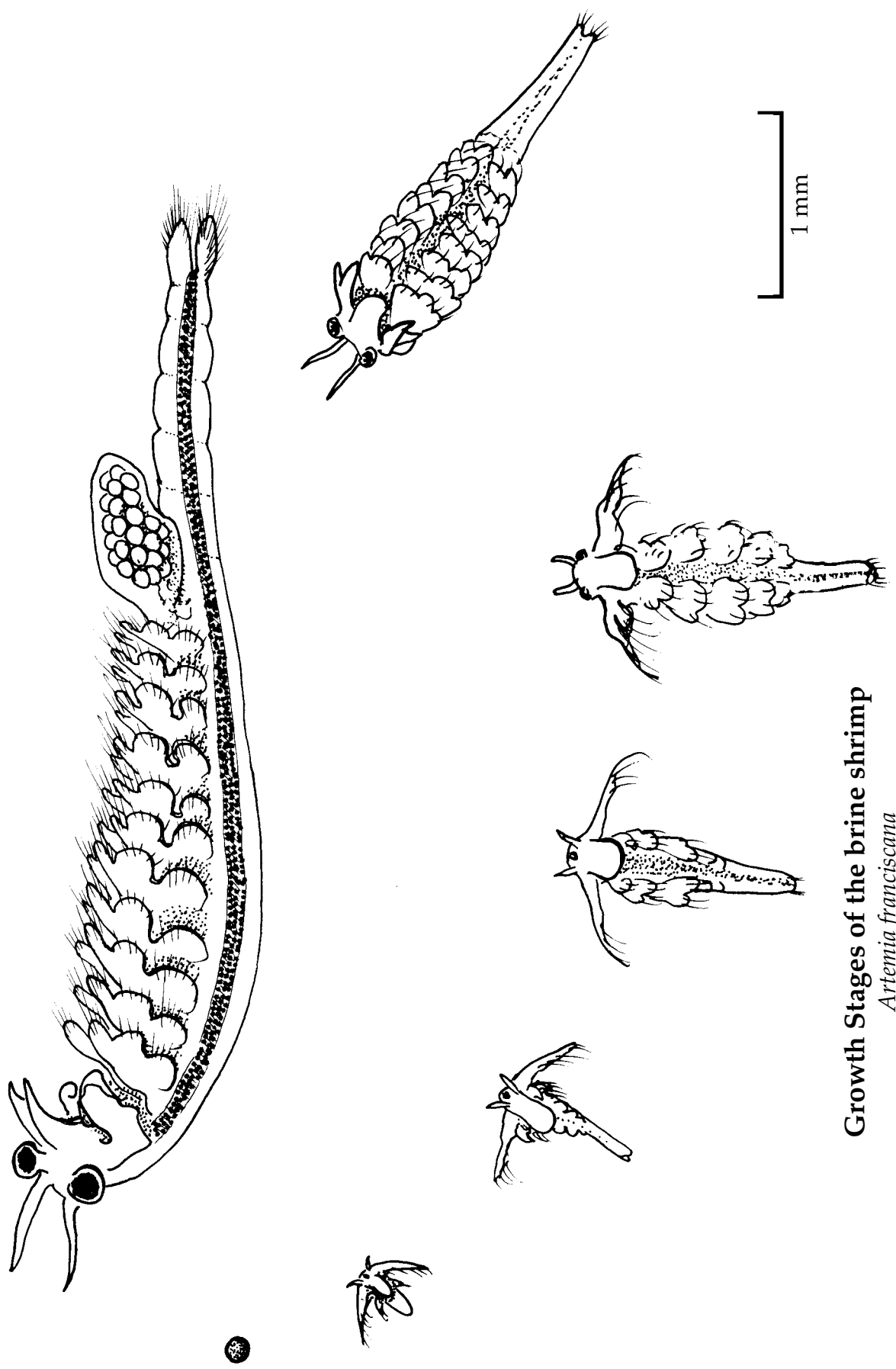

Growth Stages of the brine shrimp
Artemia franciscana

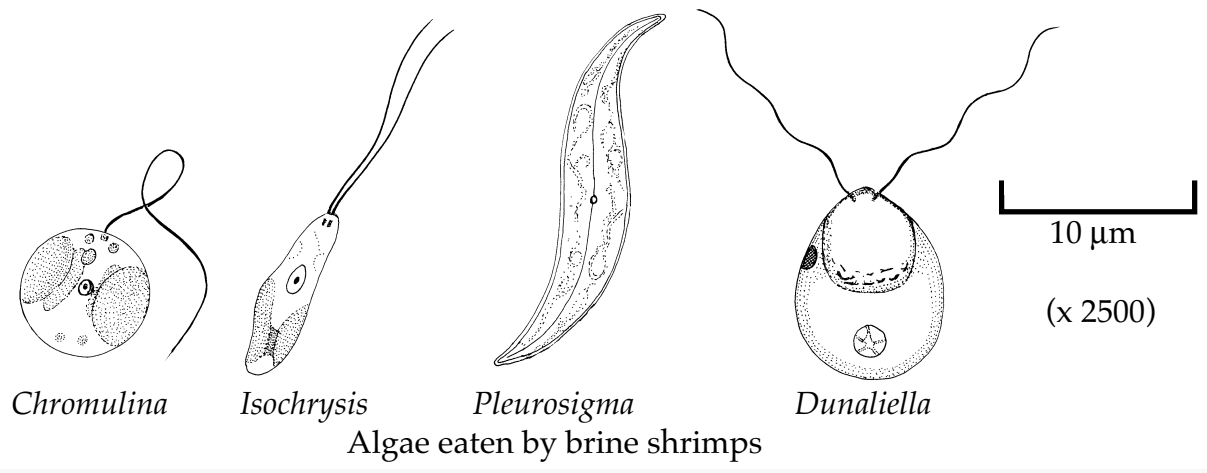
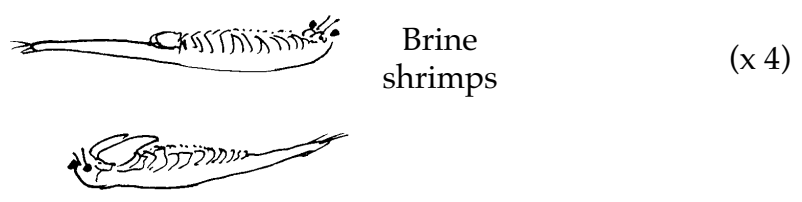
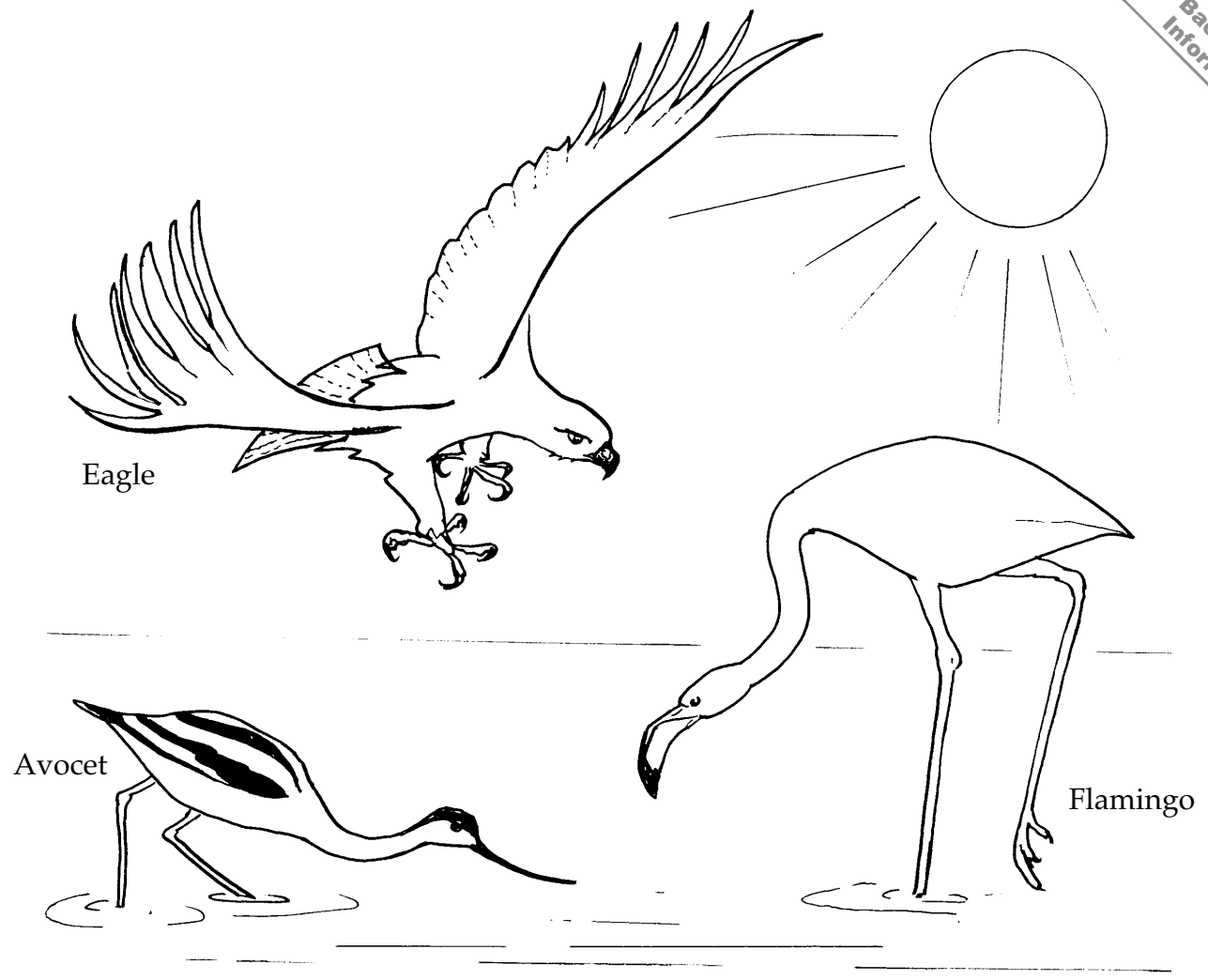

Organisms in the brine shrimp food web

Various types of algae; brine shrimps; avocet and greater flamingo; eagle

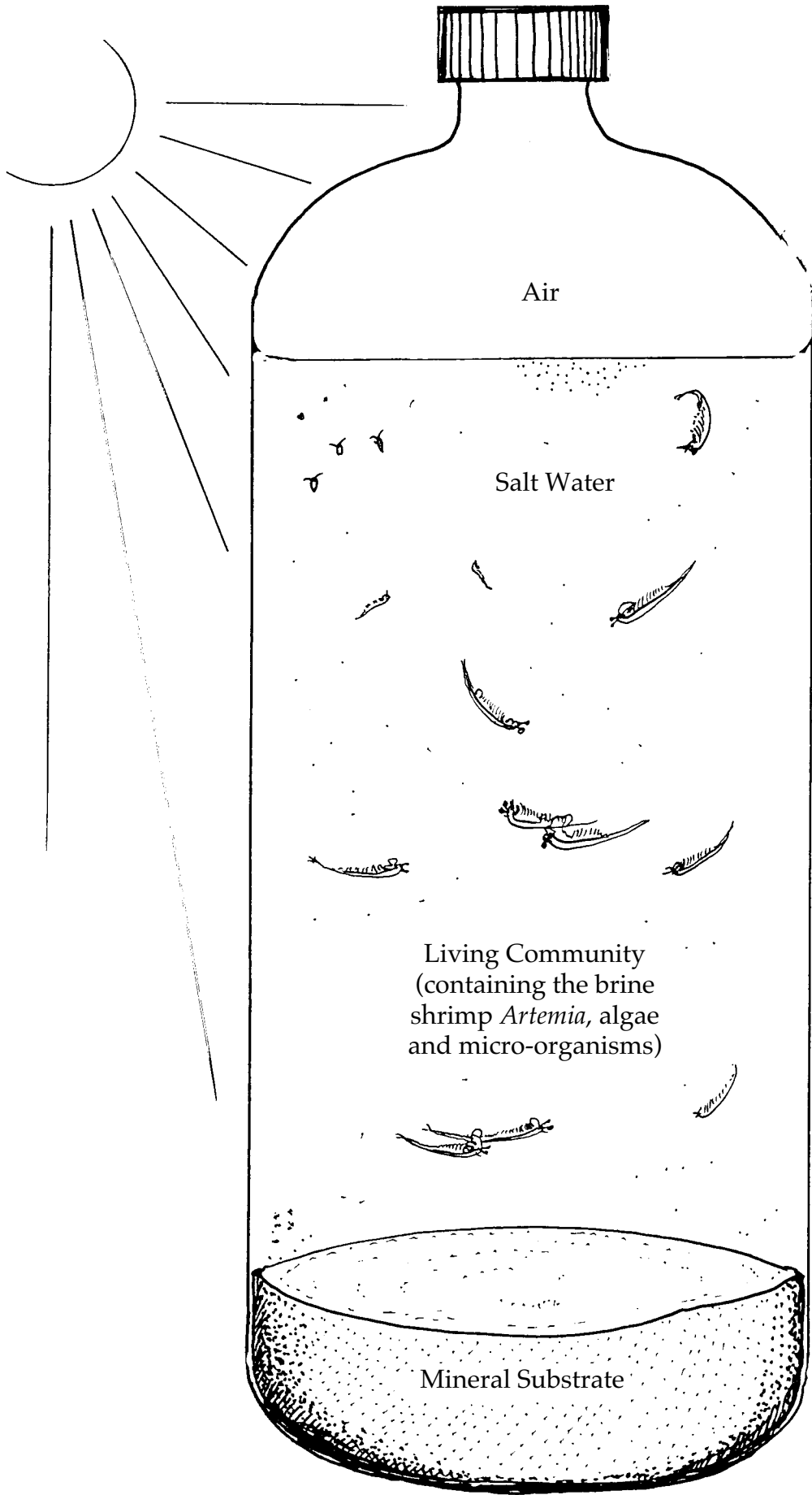

The brine shrimp bottle ecosystem

Section 5

The practical brine shrimp guide

HOW TO SET UP A BRINE SHRIMP CULTURE

Most of the shrimp eggs in commercial packs originally come from salt lakes, like Lake Utah in the USA. The species in these packs is *Artemia franciscana*. The microbial culture supplied has a mixed origin, but has been lab-based for a decade. Some of the microbes come into your tank on the dried surface of the egg cysts, others are descendants of microbial organisms in sea water. Important algae are species such as *Tetraselmis* and *Dunaliella*. The microbial ecosystem, once it establishes itself in a stable form, contains a community of bacteria and algae that fully supports the shrimps. The microbial community should grow and reproduce itself alongside the shrimps.

To get started

You need:

- (a) the **microbial culture** from an existing and successful tank of the brine shrimp ecosystem. See *Instructions*, below;
- (b) the dried **brine shrimp egg cysts** (dormant embryos). These look like finely ground pepper.

Apparatus needed for developing an initial small culture in a bottle

A brine shrimp culture has six requirements:

- (i) A clear plastic bottle of 1-3 litres, with a screw-cap (e.g. mineral water or drinks bottle), will suffice but a small aquarium tank is preferable.
- (ii) A south-facing window for a good supply of sunlight. Sunlight alone will do, especially in the summer months, but a supplementary light source, such as a bench lamp, will help with light and heat in the winter. Try to give brine shrimps at least a 12 hour 'day'.
- (iii) A temperature of more than 20 degrees Celsius is ideal for the development of shrimps. They need temperatures of 25° C for optimal hatching. Shrimps may survive easily at less than 20° C, but they will not hatch or breed if too cold. The light and warmth of a lamp will help to promote egg cyst hatching in the winter.
- (iv) Sea salt : either *Instant Ocean* for marine aquaria or a commercial cooking 'sea salt'.
- (v) A liquid fertiliser such as *Baby Bio*.
- (vi) Some washed quartz builders' sand (3 parts by weight) and crushed limestone or sea-shell (1 part) are required for the material at the bottom of the culture container. (Oyster shell grit is a useful shell material and is obtainable from poultry feed merchants or pet shops.)

Instructions on how to get your culture started

1. On arrival of the living material, open the container of **microbial culture** to the air and place it in the light.
2. Make up the desired volume of tap water and sea salt at a concentration of 35 g salt per litre (3.5%).
3. Set up the bottle container with 2-3 cm depth of washed sand and oyster shell. This will be the home for the ecosystem decomposers.
4. Test the pH to make sure it is alkaline. Sodium carbonate may need to be added to get the pH to the optimum of 8.5. Now add the culture to this solution and shake the bottle well. Leave the screw-cap off the bottle.
5. Add one **drop** only of liquid fertiliser (e.g. *Baby Bio*) per litre. Keep the culture well lit and warm, preferably up to about 25° C, for a week.
6. After one week, there should be signs of green algal growth. Now add a pinch of **brine shrimp egg cysts**. These keep indefinitely in a cool, dry environment and will hatch quickly in warm, salty water.
7. After 48 hours there will be many small shrimp larvae. These are called nauplii (pronounced 'nor-plee-ee'). These should grow to adulthood in as little as a fortnight, depending on the conditions.
8. Initially add one drop of fertiliser per litre per week. Fertiliser is used directly by the algae as a nutrient. The algae are eaten by the shrimps. The ecosystem should eventually support 12 adult shrimps to the litre. Once the full population has developed the addition of fertiliser should be reduced. Over-dosing with fertiliser will kill the algae. Try not to have too much algal growth visible.
9. Once a week put on the cap firmly and roll the bottle gently on its side. This helps mineral nutrient cycling and keeps the sides of the bottle clear of algae to allow in the light.

Setting up a larger culture

1. Obtain an aquarium that may be lit with a good light source and perhaps heated if the lab. is below 20° C. Compute the volume in litres (dm³) of the tank, e.g. a tank measuring 25 cm wide by 80 cm long with an inside depth of 25 cm = 50 000 cm³. i.e. 50 litres or dm³. Make up the volume with 35 g sea salt per litre of tap water (i.e. 3.5% salt solution). In the example above this would be 50 x 35 g = 1.75 kg of salt.
2. Add sand and shell to the bottom, add no more

- than one drop of liquid fertiliser per litre and then add to the tank the initial culture that has been built up in the plastic bottle.
3. Make a weekly addition of fertiliser (one drop per litre) until the brine shrimp community is fully established as breeding adults at this larger volume. The tank may support at least 12 adults to the litre.
 4. Stir the tank once per week and clean the glass with a suitable scraper.
 5. Temperatures for hatching should be 25° C, but the shrimps themselves will thrive at temperatures as low as 15° C. Temperatures up to blood heat are tolerated, but in a sun-lit greenhouse in midsummer cultures may be overheated. In this case the egg cysts will survive and the population re-establishes itself quite quickly.
 6. Light for algal growth is essential. A south facing window is sufficient except in winter, when additional lighting (and heating) is a help. A large 'grow-light' or light-bank will produce rapid algal growth and hence shrimp growth.
 7. Brine shrimp cultures may be kept indefinitely. If you want to run a culture down to a dormant state (e.g. over the summer holidays), merely allow the water to evaporate fully from July onwards. Even the microbes can survive in a very briny or dry dormant state.
 8. Generally adult shrimps will die in the container after some months. In this case their remains will decompose, be further decomposed by the bacteria and be returned to the ecosystem through plant cell uptake in fresh algal growth.
- See also pages 98 and 99**

BRINE SHRIMP LIFE HISTORY - background information

Brine shrimps are examples of invertebrates with jointed legs (arthropods) and are classified in the sub-Phylum Crustacea. There is a huge diversity in this group of animals, from barnacles to lobsters. Brine shrimps are amongst the most primitive and are classified with water-fleas as Branchiopods, having gills combined with their limbs. There are many species of brine shrimp, all in the genus *Artemia*, with a global distribution. As their common name implies they are found in salt lakes and brine ponds. These environments generally dry up completely in the hottest season. The ecological conditions in which these populations occur are often extreme (for example, the salinity of the water can exceed 280 g salts per litre - sea water is 35 g per litre), and thus only a small variety of algae and bacteria can survive. As a consequence, blooms of specific algal species occur and the more usually green water may occasionally appear red or blue. Very few invertebrates can tolerate these conditions but *Artemia* species have successfully adapted to such extreme environments. As a consequence, and because there are no fish predators, their numbers are often very high. The natural predators of the brine shrimp are birds like flamingoes and avocets that fly in to visit this environment when the shrimps are booming in numbers.

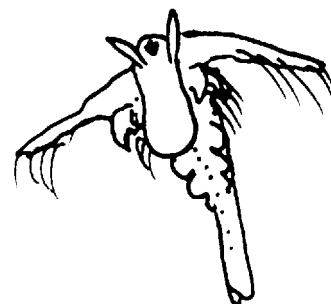

At the end of the year in the Great Salt Lake, Utah, U.S.A., the salt water takes on a brownish colour, due to very small brown particles appearing at the water surface. These small particles are the inactive dry egg cysts of *Artemia franciscana*. These egg cysts drift in the wind and waves to the shore in huge numbers and are collected from the lake shore commercially to provide the dried brine shrimp eggs that are sold in aquarists and pet shops in Britain. The egg cysts remain dormant as long as they are dry. They contain a protective polysaccharide called trehalose which preserves life in a desiccated state. Trehalose is also found in the seeds and tissues of desert plants resistant to severe drought. In the early spring the over-wintering egg cysts hatch at the first rains (April). The cyst hydrates and the shrimp embryo becomes active. Some hours later the cyst bursts and the embryo emerges, surrounded by only the hatching membrane. At this stage the single eye of the nauplius larva is visible. Within a few hours the antennae and mandibles start moving and then the nauplius begins swimming. This first stage larva is orange/brown in colour.

The larva goes through about 15 moults and as it does so the trunk and abdomen lengthen. At first,

the antennae collect food particles and at this stage lateral compound eyes first develop. Soon the middle instars begin feeding with their paired legs. Shrimps, from this stage on, swim on their backs with their legs on the uppermost side. The eleven pairs of legs are used for three purposes, namely, as filters, for locomotion and as gills. From the tenth instar on, significant sexual changes occur. The most marked of these is that the male antennae develop into large, hooked claspers which will be used to grab the female during the mate guarding phase of reproductive behaviour.

The adult animals are 8-10 mm long when fully grown. The males have a translucent body, large claspers and a paired penis may be seen in the posterior part of the trunk region. The females are brown/red in colour and have a brood-pouch (or uterus) which receives ripe oocytes from the ovaries via two oviducts. The sexes differ in colour, older females are darker brown whilst older males accumulate a blue-green pigment. The pre-copulation or guarding phase is initiated by the male who grasps the female with his claspers between the uterus and the last pair of thoracopods. In this 'riding position' the two animals can swim around for many hours, even days.

When copulation occurs it is a fast reflex. The male abdomen is bent forward and one of the pair of penises is inserted into the aperture of the uterus. The fertilised eggs develop in two possible ways. (1) The first generation of eggs (in the Great Salt Lake this is in May or June) often develop immediately into free-swimming nauplii when released by the female. This is termed ovoviviparous reproduction. (2) This May/June population goes on to produce a larger proportion of much browner eggs that do not hatch immediately. These brown egg cysts have a thick shell and are dormant until stimulated to continue development by a change in environmental conditions. Ovoviviparity (1) is common in booming populations, whilst a population in which nutrient levels or other necessary conditions are declining will produce more of the dormant egg cysts (2). There may be up to five generations in one year in the Great Salt Lake. Population densities in the wild may exceed 10 shrimps to the litre, levels that may easily be exceeded in laboratory culture.

Growth rates in the wild are affected by temperature and nutrition. At 25° C with optimal nutrients adults are sexually mature in 14 days and achieve full size in 26 days. As salinity increases growth rate and final size decrease. Brine shrimps will live in more than 20% salt but at 18% their growth rate is half that at 3.5%. This is due in part to the costs of salt secretion (see below). At low salinities, < 3.5% salt, *Artemia* grows well but competes less well with other more freshwater species and does not thrive as well as in a more salty environment.

Physiologically *Artemia* is a hypo-osmotic regulator in saline solutions (Croghan 1958). This means that the animal's blood is hypotonic to the medium outside (having less dissolved solutes) and that water is therefore lost by osmosis through the outer integument. To prevent desiccation the continual flow of ingested water through the gut is believed to be the source of water uptake but as this water is also salty, powerful salt secretion from the gill surfaces occurs at the same time to compensate for the salt inadvertently gained. The pumping of ions across membranes is energy demanding and hence although the saline environment is one where growth can be rapid there is a cost to living there if the medium becomes too salty.

Further reading:

Croghan, P.C. (1958). The osmotic and ionic regulation of *Artemia salina* (L). *J. Exp. Biol.* **35**, 219-233.

Cuellar, O. (1990). Ecology of Brine Shrimp from The Great Salt Lake, Utah, USA. *Crustaceana*, **59** (1). E.J.Brill, Leiden.

Persoone, G. & Sorgeloos, P. (1980). General aspects of the ecology and biogeography of *Artemia*. In Persoone, G. *et al.* The Brine Shrimp *Artemia*. Volume 3 Universa Press, Wetteren, Belgium.

Wear, R.G. *et al.* (1986). The effects of temperature and salinity on the biology of *Artemia* 2. Maturation, fecundity and generation times. *J. Exp. Mar. Biol. Eco.* **98**, 167-183.

Williams, W.D. (1995). Inland lakes of brine: living worlds within themselves. *The Biologist*, **42** (2), 57-60.

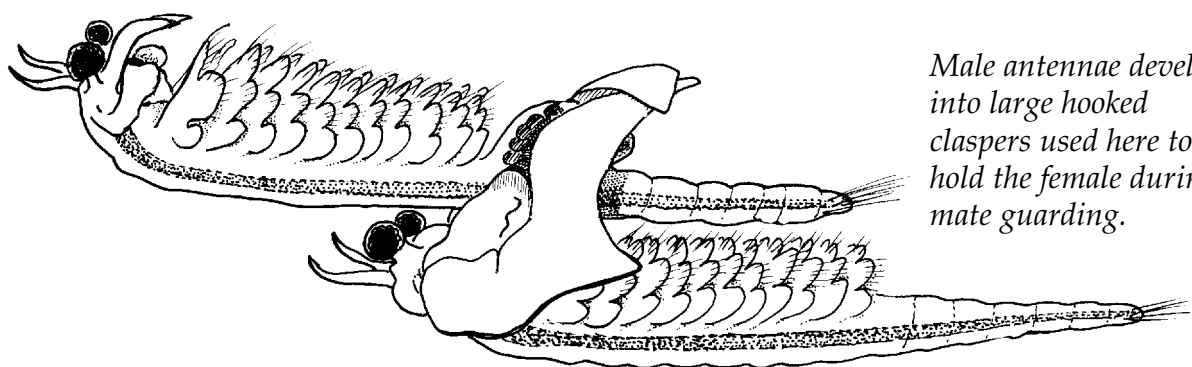

Male antennae develop into large hooked claspers used here to hold the female during mate guarding.

HANDLING BRINE SHRIMPS IN THE CLASSROOM - some practical tips and ethical issues

Brine shrimps are very delicate animals and one must take care not to harm them when they are handled. Refer to the student work sheet on *Handling and observing brine shrimps* (page 6).

Firstly, brine shrimps should always be in water of *at least* 10 g per litre salt (preferably 35 g per litre). Do not use fresh water or tap water - although they will survive for some days in these media. When in the salt solution and supported by the water they are resilient and quite hardy within their aquatic environment. For example, they are not harmed at all by gentle stirring of the environment or rolling of the culture bottle (or bottle ecosystem) to clean 'the windows'.

Teachers should be careful to engender a good ethical attitude towards these animals and not a totally instrumental one. Although they are simple organisms that may not 'suffer' in the same way as higher animals, they still demand respect. This is particularly true when experiments are set up to establish the parameters favoured by the shrimps, e.g. temperature preferences and pollution tolerance. Animals should go back into the holding tank after being examined. This engenders the ethics that are commensurate with field work where pond animals are returned to their habitat after observations have been made.

The best way to catch shrimps from a tank is to go fishing for them with a fine sieve. Shrimps may be lifted out easily for transfer to experimental vessels (using a tea-strainer is ideal). They should be lowered into a small beaker and allowed to swim free. Don't let them dry up in the sieve. A coarse sieve of 2-3 mm mesh will catch only adults.

If you pour water containing shrimps through a cotton pocket handkerchief that is supported by a

funnel, it will separate all the shrimps, larvae and eggs from the water. However as most of the algae will pass through a cotton handkerchief this is useful if you are wanting to culture the algae alone.

To pick up a shrimp from the water use a pipette. The most suitable pipettes are made of soft plastic with inside bore of at least 5 mm. Cut off the pointed end of the pipette so as to make a tube that is wide enough for the adults to enter when sucked. This should have a bore of 3-5 mm. When sucked up the shrimp will not be distressed and will not escape from the water. The animals are robust in water, but of course are not to be handled out of this medium.

To put a shrimp on a slide take a clean glass slide and gently rub it dry and shiny. Put just a few drops of water with the shrimp onto the slide. Suck up any extra water so that the shrimp is confined in a blob of water. Remember that water has a high surface tension. Shrimps may be restrained in a few drops of water by surface tension. Glassware that has detergent on it will therefore not behave in this way. The water must not dry up, so add just one drop of water every minute or two. A sheet of graph paper, with millimetre squares, photocopied onto a single overhead transparency acetate sheet, will provide a 'non-wettable' metricated surface ideal for shrimp observations.

If you place this slide or acetate sheet beneath a hand-lens (e.g. x 10) or under a low power microscope (e.g. x 40) you can observe much detail. **Always release the animals back into their tank after about five minutes.** Small shrimps, eggs and naupliar larvae may be suspended in a hanging drop on a cover-slip. Observation in the hanging drop may be made at up to 100x magnification, when this is placed above a clear plastic film can lid. Sustained observation here is possible without great evaporation of water from the hanging droplet.

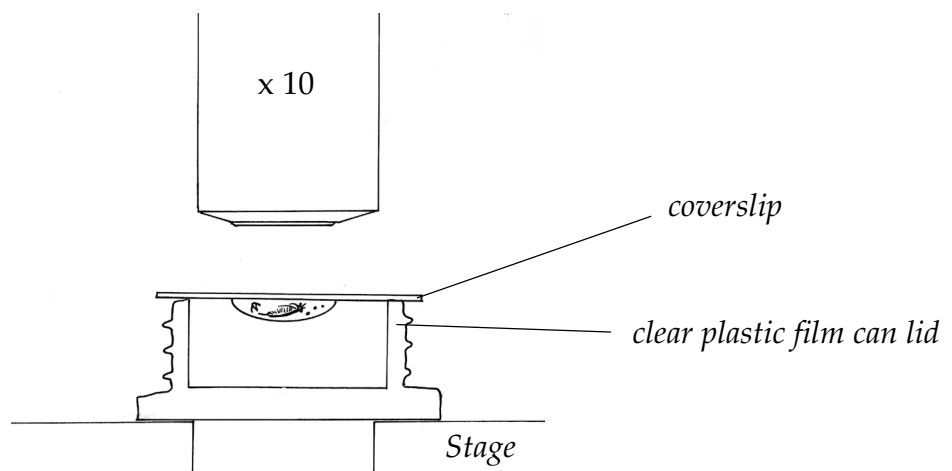

THE LABORATORY TECHNICIAN'S GUIDE

Technicians working to support class work with brine shrimps need to know how to culture stocks and to prepare materials for a class. It is suggested that before any teaching programme is set up the technicians satisfy themselves that they can grow cultures as and when they are wanted. It is important to understand the natural ecosystem, the way in which cultures are set up and the ways of handling the animals themselves. You should therefore read the three sections preceding this one in *The practical brine shrimp guide*.

Sea salt

Although sea salt is predominantly sodium chloride it also contains much smaller amounts of calcium, magnesium and potassium ions, as well as bicarbonate and sulphate ions. Any commercial sea salt (as sold in a supermarket store) is suitable for cultures, provided that a supply of trace elements is occasionally added. These are obtainable from shops supplying marine aquarists with sea salt. The commercial sea salt aquarists use is moderately expensive but has all these minor nutrients already added. *Instant Ocean* is a good commercial variety. It goes without saying that any school near the sea could use sea water without any problems provided that the water is unpolluted.

Deciding salt concentrations

Brine shrimps will thrive in salty water between 2% and 15% salt by weight. At low salt concentrations other organisms that are not adapted to the brine shrimp habitat may grow. It is therefore best to have the salt between 3 and 5% strength. Sea water is 3.5% salt and thus making up tank water with **35 grams to the litre** should be standard. At higher salinities than 5% there is a slow decrease in growth rates. Hatching is little affected by salinities as high as 18% but at this salinity the rate of growth of shrimps is much reduced and eventual body length (10 mm) is smaller.

To calculate **tank volumes** measure the inside dimensions. Compute the volume in litres (dm^3) of the tank e.g. a tank measuring 25 cm wide by 80 cm long with an inside depth of 25 cm deep = 50 000 cm^3 i.e. 50 litres (dm^3). Make up the volume with 35 g sea salt per litre of tap water (i.e. 3.5% salt solution). In the example above this would be $50 \times 35 \text{ g} = 1.75$ kilos of salt. Weigh out the needed salt and make it up with tap water. The chlorine in the **tap water** is not a problem as it will soon evaporate off. Tap water can be de-chlorinated by leaving it to stand for 48 hours.

Monitoring salt concentrations

As shrimps will be removed from the holding tank in the lab, and as the tank will occasionally need topping up, it is advisable to keep an eye on the **salinity**. This is best done with a hydrometer that measures the relative density (specific gravity). This is a piece of apparatus that may be in your Physics department. The relative density of distilled water at 20° C is 1.000. A hydrometer put into the tank will read off the density of the solution relative to the density of distilled water. A tank between 3.5% and 5% salt will have a relative density between 1.029 and 1.041. Aim therefore for an **RD of between 1.03 and 1.04**. If you want to calculate the percentage of salt from the relative density, then $(\text{RD} - 1) \times 120 = \%$ sea salt. At 20° C, saturated sea salt solutions, in which the salt is crystallising out, have a RD of 1.23 (i.e. 28%). Brine shrimps have difficulty in living in salt above 20% strength but even in a saturated brine tank there may be a few survivors living!

Sand and shell

The tank bottom should be covered with a fine sand. Washed builders sand is ideal. In order to buffer any acidity it is useful to include some shell in the tank. Crushed oyster shell, fine grade, is available from stockists of poultry food (it is used to help chickens make stronger egg shells). Mixing sand and shell 3:1 and then **washing it thoroughly** in several changes of tap water will give good results. A 2 cm depth of this substratum in a bottle or tank is ideal.

The microbial flora

The culture of brine shrimps, if it is to be achieved in a simulated ecosystem, is wholly dependent upon the microbial flora. This is supplied with cultures. This should be added to a bottle culture first. All being well the algae will begin to grow in a few days. Addition of no more than one drop of liquid manure per litre per week (e.g. *Baby-Bio*) will set the algal system going if it does not take off on its own. **Algae** need air (carbon dioxide and oxygen) supplies, mineral nutrients (NPK) and, of course, light to grow. They also need a suitable temperature. The algae will be of many species, but the most useful in saline tanks is undoubtedly *Dunaliella*. This looks ovoid and bright green down a microscope and jiggles about, as it swims with flagella. Blue green algae (cyanobacteria) may also be seen on the sides of the tank. Some of these species are nitrogen fixing. The culture will also contain true bacteria that will cause the decay of dead shrimps and any other dead plant or animal material. This is an important part of the ecosystem and **these bacteria**

do not present a health hazard. The tank may be stirred by hand without danger provided that hands are washed thoroughly afterwards.

Light

Direct sunlight is very valuable for algal growth. Because of cost and brightness it is much to be preferred to electric light. The Homerton cultures do well in a greenhouse in summer and in a tank lit by a Gro-light in winter. A south facing window-sill or lab bench by a south window is ideal. Algal cultures will not do well in a dark corner of the prep room. There is no upper limit to the brightness of the light (see heating). A long day is preferred i.e. 18 - 20 hours of 'daylight' if electric sources are to be used.

Heating

Direct sunlight is enough to heat a tank all summer at typical summer temperatures, but in winter growth will slow down if the tank falls below 20° C. In winter therefore an aquarium heater might be added. Shrimps will live but not mate or breed at 15° C.

Bottles and tanks

A good plastic bottle size for class work is 1.5 litres. Small bottles of 0.33 litres are ideal for short term experiments. Clear **soda water and Coke bottles** are ideal. Wash these thoroughly. Remove the labels by putting hot water, at about 60° C, into the bottle and gently peel off the label. **Early warning:** if students are going to keep their own shrimps then they should find their own bottle aquarium. Culture bottles should be left open to the air, with the cap lightly screwed on.

An aquarium tank of any size is better than a plastic bottle for longer term cultures. Two 25 litre tanks at different stages of development might provide more interest than one 50 litre tank. Glass tanks are less likely to become scratched by the sand than plastic ones. Plastic (perspex) tanks may have their scratches reduced by polishing with a metal polish (such as *Duraglit*).

Adding nutrients

This is the most difficult thing to get right. Slow release of mineral ions is optimal for algal growth. As with feeding a plant, little and often is likely to be more successful than too much nutrient given too infrequently. Some dead organic material in the tank is a good source of nutrient as this breaks down slowly and releases mineral nutrients into the tank. Do not give more than **one drop of liquid fertiliser per litre per week**.

Stirring the tanks or bottles

There are two reasons for stirring the tanks and bottles: cleaning algae off the tank walls and re-distributing nutrients. Algae will grow on the inside of the plastic bottle or glass. Brine shrimps cannot easily feed off a flat surface, like a browsing pond snail would, so you need therefore to re-suspend the algae in the water by cleaning the 'windows'. In a tank, a flat spatula scraper is ideal. Give the tank a firm stir of all the bottom substrate material. This will not harm the animals at all. For a bottle stir, screw on the cap tightly, tip the bottle on its side so that the sand is all along its length. Then roll the bottle gently to clean the sides. Turn the bottle upright and shake it a few times to dislodge sand from the top. The tank and bottle will also gain by stirring as this will raise nutrients from the bottom and shift them into suspension. This should provide resources for the algae to grow again. **Stir tanks and bottles once a week.**

Obtaining egg cysts

Brine shrimp egg cysts are supplied by most pet shops to provide aquarists with a suitable food for fish fry. They are relatively expensive for their weight but cost per shrimp is low as there are approximately 24 000 egg cysts per gram. This means that the smallest pinch of egg cysts will provide enough for a large tank to be colonised. A million eggs cost only a pound or two. **Sciento, King British, New Technology and Interpet** are trade name suppliers. Once a cycle of shrimp keeping has been carried out in a school, the dormant egg cysts may be collected from the sides of the aquarium tank where they adhere. If a completely dry tank is refilled with tap water to its former salt water level a successful hatching generally follows if other conditions are right.

Hatching shrimps

Brine shrimps will hatch optimally in brine which is 2 to 5% salt (optimum 2.8%), at pH 8.5, and at 25° to 30° C (optimum 28 C). There must be access to air (for oxygen) and light is an added but not essential factor promoting hatching. An open container, such as a small beaker, is ideal as a hatching container. Nauplii hatch out in 24 hours at optimal temperatures. They will immediately swim towards a light source and may be collected by pipette and placed into a larger container with algae. As larval mortality is high there is a commercial feed *Liquizell* which has proven qualities as an initial food. See *Student Activity 4*.

Data logging of the ecosystem

Collecting and storing data on brine shrimp communities may be done with some simple ICT support for classroom teaching. Probes may be placed in tanks or bottles without any harm to the organisms. Using a suitable probe (e.g. light, pH or oxygen) coupled to a data logger (e.g. LogIT Data Meter 1000), and a suitable generic software program, one may keep an eye on changes. For example, a pH rise and fall will take place in the 'day' and 'night' respectively. This observation of the fall and rise in carbon dioxide levels might be coupled to the light level. In the best systems the logger and software recognise the type of sensor attached to it and adjust the calibration of the display accordingly. LogIT has three data input channels for simultaneous use. The best data loggers can be used remotely from computers; these may be used in the field. Ideally they may also be coupled to pocket book computers.

Algicides

If using *Simazine* for pollution investigations, study the notes on pages 63 and 64. These cover the experimental background, risk assessment information and disposal. This chemical is not a hazard to human health in the form supplied by Homerton College but is hazardous to plants and the environment.

Brine shrimp helpline

Advice is often available on 01223 507175.

New algal / microbial cultures

Fresh cultures of the essential algae and microbial communities are obtainable from either **Blades Biological** or from the **Brine Shrimp Ecology Project**.

See Sources of supply on page 99.

Trouble shooting

Common causes of failure with a shrimp culture are:

- | | |
|---|---|
| <ul style="list-style-type: none"> • too cold Breeding will not occur readily below 25° C - warm it up. • too hot Shrimps will die if, for example, they are overheated in a greenhouse. • too little light Algae will not grow without illumination - add light, from perhaps a bench lamp or Gro-light. • too salty Shrimps grow slowly and are small - check with hydrometer and dilute. • too little salt Poor condition of shrimps - check with hydrometer and add more salt. | <ul style="list-style-type: none"> • too many nutrients Eutrophication has occurred. Oxygen levels may have fallen and high levels of nitrite may be present. It will help to oxygenate the water with an aquarium pump. • too few nutrients There are no mineral resources for algal growth. • too old Shrimp cultures 'boom and bust' . If there are large numbers of dormant egg cysts on the surface and the shrimps are dying off let the tank dry up and start a fresh culture in a second tank, with microbial culture from the first. Add a fresh hatch of shrimps. |
|---|---|

SOURCES OF SUPPLY FOR TEACHING MATERIALS

Brine shrimp egg cysts

These are supplied by most pet shops. **King British, New Technology** and **Interpet** are trade name suppliers. They may also be purchased from Sciento, 61 Old Bury Road, Whitefield, Manchester M45 6TB tel: 01617 736338

or

Blades Biological
Cowden
Eaden Bridge
Kent TN8 7DX

tel: 01342 850242 for information on cost and postage or see <http://www.blades-bio.co.uk/>

Once a cycle of shrimp keeping has been carried out, the dormant egg cysts may be collected from the sides of the aquarium tank where they adhere. If a completely dry tank is refilled with tap water to its former salt water level a successful hatching generally follows if other conditions are right.

Algal and microbial cultures

Fresh alga and microbial cultures are obtainable from:

Blades Biological
Cowden
Eaden Bridge
Kent TN8 7DX

tel: 01342 850242 for information on cost and postage or see <http://www.blades-bio.co.uk/>

or

The Brine Shrimp Ecology Project
Science Education laboratories
c/o Homerton College site
Cambridge
CB2 2PH

tel: 01223 507175 for
information on cost and postage

Fertilisers

Baby Bio is obtainable from most garden centres and from the manufacturer: Pan Britannic Industries Limited, Britannic House, Waltham Cross, Herts EN8 7DY.

Larval foods

Liquizell is obtainable from most aquarist and pet shops or from the manufacturer DOHSE AQUARISTIK, Auf der Kaiserfuhr 39, 5300 Bonn 1. Germany.

Algicides

Algomin is obtainable from most aquarist and pet shops or from the manufacturer Tetra. *Algomin* contains *Simazine*, a persistent algicide.

Simazine is available from the Brine Shrimp Ecology Project at 1% strength with health and safety data, approved by CLEAPSS.

Nitrate testing

Nitrate-test strips are obtainable from laboratory suppliers such as Griffin and Philip Harris or from the manufacturer E. Merck, 64271 Darmstadt, Germany. Tel: 0049 6151720.

Sea salt

Supermarkets and health food shops supply **sea salt** for human consumption. Some of these may lack trace elements important for shrimps in long term culture, so using a marine aquarist sea salt will fully guarantee good mineral nutrition. *Instant Ocean, Forty Fathoms, Kent Marine* and *Tropic Marin* are four varieties. These retail at £3 per kilo in bulk, i.e. about 10 pence per litre of shrimp brine. Ordinary sea salt is much cheaper.

Section 6

Additional notes in support of teaching and assessment

BRINE SHRIMPS AND SCIENCE 1 INVESTIGATIONS

This section is specifically targeted at the practical teacher-assessed component of the National Curriculum of England and Wales and is written mainly for the benefit of those already familiar with it. The specific details of the Programmes of Study and of the assessment criteria at the various levels have not been included because these are subject to change and up-to-date generic information will be readily available to teachers who need it. Even where criteria remain essentially the same, standardising material provided by examination boards may indicate changes in emphasis and minor adjustments from year to year. This book provides ideas, techniques and background information which provide a lot of scope for development by individual teachers in particular circumstances. For clarification of criteria and to resolve problems in marking specific GCSE assessment work, a teacher should consult his or her moderator.

The brine shrimp model ecosystem provides a means that lends itself to the introduction of ecology, as a motivating, investigative and predictive science, into the secondary school laboratory and classroom. Students can even extend their observations by taking their model ecosystems home. The materials and equipment are so inexpensive that it is possible to have large numbers of bottle ecosystems and for each student to have one or more bottles to work with. There are two ways in which **assessment of student learning** might be approached.

Whole investigation:

After attempting one or more of the activities designed in this book a student would be in a position to conduct a whole investigation with planning, observing, analysis and evaluation.

One, two or three skill assessment:

This may offer a lot of scope for creative use of assessment combined with simultaneous teaching of theory and techniques. An investigation might, for example, be initiated by the teacher helping the class to plan it and to collect data as a group activity whilst requiring the students to present and analyse the data and to evaluate the conclusions. Many of the activities in Section 2 could be used as starting points if presented in an open-ended way.

It should be noted that

- **Students sometimes have difficulty defining a hypothesis and justifying a prediction because they may not have acquired enough theoretical knowledge and understanding.** The 'let's see what happens if ...' approach can be an important

aspect of teaching science even if it does not necessarily fit the assessment criteria for every skill area. To deny this may stifle true scientific enquiry. Such an approach may get no more than a low level planning mark yet offer scope to achieve a higher standard in observation (carrying out), analysis and /or evaluation, and to learn some good science at the same time.

- **To analyse and evaluate data a student normally needs to have been directly involved in its collection** either working alone or in a group, whether or not observational skills are actually to be assessed.
- **Group work might invalidate assessment of observational/carrying out skills** because it is often (although not by any means always) impossible to judge the quality of the contribution by each individual. This would not, however, preclude the assessment of planning, analysis and evaluation. Despite the inexpensive nature of bottle ecosystems there could be logistic problems in providing each student in a class (or even year group) with six bottle ecosystems in order to work independently and to provide replication. In such cases a large amount of class data would provide the basis for high level analysis and evaluation but not necessarily planning and observation.

Exemplar assessment:

The Nitrate Question: fertiliser or pollutant?

Here we examine how the brine shrimp ecosystem can be used to investigate the effects of increasing fertiliser levels on the growth of algae and shrimps. This might be done in the learning context of the class studying the way that pollutants (farm slurry or arable fertiliser run-off) affect life in rivers and streams.

Could we use brine shrimps to see what effects fertilisers have? Here we employ them in a model of eutrophication (nutrient enrichment) of the environment.

A student working around levels 1 to 4

Student 1 needed a lot of help. He was interested in the idea that shrimps fed on algae and that algae were plants just as much as geraniums. Since fertiliser made geraniums grow then presumably they also made algae grow. He needed a lot of prompting to realise that more food should mean more brine shrimps and that therefore more fertiliser would mean more shrimps even though

shrimps weren't supposed to need fertiliser. With a little help from his teacher he devised an experiment with three small bottles of brine, one with one NPK fertiliser pellet, another with a huge (but uncounted) number and the third bottle without any pellets at all. He himself decided to put the same volume (50 cm³) of algae rich water and the same number of young shrimps (30) in each, although he had to be reminded to put the bottles on a sunny window sill because plants need light to grow.

Student 1 recorded in a simple table, which he made himself, the number of shrimps he counted in the three bottles. He did this faithfully twice a week for three weeks. The bottle with one fertiliser pellet added ended up with most shrimps. They were also slightly larger, but he did not record this although he had noticed it when asked. The third bottle went very green and not all the shrimps survived. He said he expected the brine shrimps in the bottle with some fertiliser in to grow better. Student 1 was puzzled by the third bottle and ignored it in his brief write-up.

Student 1 needed a lot of help yet he did manage to make a valid prediction (but not to justify it scientifically), to design a simple fair test and to select some apparatus and so he was awarded **P4** for planning. His observation was carried out conscientiously but there was not much to observe and he achieved **O2**. He needed a lot of help even to make a simple conclusion, **A2**, and made no effort at evaluation, **E0**.

A student working around levels 4 to 6

Student 2 was clear that the fertiliser added should make the algae grow. She decided that measuring the algae would be difficult but she was able to measure the brine shrimps. She made a prediction that the more fertiliser is added to the water the faster the shrimps would grow. She also recognised the importance of light and insisted that the light be controlled by having all the bottles in a row along the same window sill. She set up, with her group, a row of plastic bottles, cut into the shape of three tall beakers so that the brine shrimps might be removed easily and individually for measurement. Into each beaker she put the same amount of initial algal culture from the tank, the same amounts of salt water, but varied the amount of fertiliser pellets that were added. She had one control with none added and then a series with 1, 2, 4, 8 and 16 pellets added (her teacher advised on this scale). Initially her group carefully added about ten young shrimps (2 mm long) to each bottle. She did not take enough care with ensuring that the young shrimps were initially the same size. This was noted by the teacher when the experiment was set up. Twice a week for four weeks each member of the group sucked up,

one at a time, a total of five shrimps from each bottle and measured them to the nearest millimetre while the shrimp was inside the pipette. The resulting measurements were recorded systematically in a table. Although there were anomalies in some bottles, Student 2 drew a histogram, the trend of which was clear. She noticed that a few results did not fit the pattern but she did not attempt to explain these anomalies. She did, however, correctly conclude that fertiliser does encourage the growth of algae and also the growth of shrimps. She wrote about the implications of nutrient enrichment on the environment.

The nature of the group work and the fact that the class was a large one meant that it was not possible to award a mark for observation because the teacher was unable to assess the contribution of the individual students. **Student 2** did, however, design a fair test, made a prediction and justified it using her knowledge of plants, although she was unable to decide a suitable range without assistance. Thus she was awarded **P5** for planning. She drew a valid conclusion but the data were not sufficiently processed to achieve level 6 and she was awarded **A4**. The evaluation mark was **E3** because she had identified anomalous results but failed to suggest any possible sources of inaccuracy.

A student working around levels 5 to 7

Student 3 was quick to recognise that fertiliser was only one of many variables that were involved in this question. He considered that it was important to keep light and temperature constant. The student played a leading role in organising the group work and he collected a lot of the data himself. The teacher noted that he worked to a high degree of accuracy. He was the student who realised that the south facing window sill on which the groups bottles were placed had a radiator beneath part of it and he took steps to make sure that temperature was not an uncontrolled variable (he had several controls within a randomised arrangement). He also devised a simple scale of 'greenness' of the water using a colour chart. The group, very much under his leadership, decided to compare the effect of *Baby Bio* liquid fertiliser on the shrimp ecosystem with the NPK fertiliser pellets. They set up two parallel investigations on the effect of the fertilisers on (a) the greenness of the water and (b) the number of shrimps that there were in the bottle. Student 3 added 30 newly hatched shrimps to each bottle at the outset. Student 3 decided to add the graded amounts of fertiliser twice a week and not just at the outset. "Its like this," he had said, "fertiliser is continually leaking into the environment where they live, doing this will make the effect more like the

same conditions of real pollution". A careful attempt was made once a week to carry out a population count. This was fraught with obstacles to accurate counting but he carefully recorded the results in a table and plotted the numbers on a graph. There was a scatter of points about the best fit line. Student 3 correctly identified the main anomalies and considered them likely to be due to observation/miscounting and inconsistencies caused by several people having been involved in collecting the data. Although there were no replicates the results showed that the fertiliser pellets were more powerful in their effect than the *Baby Bio*, but there was no real equivalence between these two that could be identified. He very clearly linked fertiliser addition to the degree of green that was produced, but there was some lack of understanding that at high rates of addition the algae themselves might suffer and that this was the cause of the numbers of brine shrimps dwindling at the highest fertiliser concentrations.

Student 3's teacher considered awarding **P6** for planning mainly because he had not used enough science to justify his predictions beyond level 6, neither had he referred to secondary sources nor preliminary work. On the other hand his approach to the design of the investigation was very good and so the teacher considered level **P7**. His approach to observation and data collection was exceptionally good and even though the lack of replication and the use of a method which did not offer enough precision, the teacher considered **O7** or even **O8**. Student 3 processed the data, producing a best fit line and drawing a simple conclusion supported by some science. He was awarded **A6**: he had not appreciated how much could be gleaned from his data. In his evaluation he very competently recognised anomalies and appreciated the potential sources of error. He evaluated the data rather than the conclusions and clearly had achieved level **E4** but the teacher wondered whether it was really worth **E5**. The teacher sought the advice of her moderator before making a final decision. Many of his class mates achieved levels 5 or 6 for most skill areas although in many cases there was insufficient evidence to award an observation mark. Student 3 was an exceptionally good student from a practical point of view. It was his knowledge and understanding which limited his performance.

A student working at level 8

Student 4 already knew from the biology part of her science course that nitrates were absorbed by plants and used to make proteins so that the plant can

grow and this was why nitrates were one of the most important components in fertilisers. Student 4, like many secondary students, had to be reminded that algae are plants with similar needs to more familiar plants such as geraniums. She had also learnt that fertiliser run-off was often regarded as a kind of pollution because it could lead to algal blooms. Her teacher proposed that she might make a special study of actual nitrate levels and use nitrate test strips to monitor how the levels change over time. She predicted that as the nitrate concentration increased so would the algal density after a period of time but also that there would be a simultaneous decrease in the nitrate concentration. She expected a linear relationship except at higher concentrations where she predicted that there would be a point where further increase in nitrate would have less and less effect on the growth of algae due to the effects of over-crowding. She justified all the predictions with good scientific knowledge and understanding.

With some direction from the teacher, Student 4 made up 100 cm³ of a 1M solution of potassium nitrate (KNO₃). Using distilled water and measured drops of her solution, she established that three drops in a litre was equivalent to 10 ppm nitrate. With the help of some preliminary work she devised a way of measuring actual levels (Merkoquant test strip) as well as adding particular levels of nitrate to produce a predictable nitrate level in a volume of water. All the beakers had equal amounts of algal culture at the outset and were placed under fluorescent lights. She rightly suggested that the beaker positions be regularly changed to ensure even heating and lighting and that the ones without shrimps in be stirred with a glass rod (as the shrimps stir the algae). Recording of algal density was carried out using a colorimeter and again she did a little preliminary work. It was clear to her that this was more accurate than reading algal levels by eye alone and she discovered it to be a very quick method. She took three measures of algal density for each sample and used the mean value (percentage absorbency) in her table for her graphs. This work necessitated quite frequent measurements.

She discovered a positive linear relationship between initial nitrate concentration and algal growth rate and she expressed this relationship in her account of the investigation with a line of best fit. There was one recognised anomaly which she thought might have been due to an error with the colorimeter (a dirty cuvette). She concluded, finally, that the larger algal populations had used up the nitrates more quickly and she explained why this was so. The results supported her prediction except that she did not demonstrate the plateau at high concentration. In her evaluation she wondered whether a still higher concentration would be needed to show this. She also realised that her use of potassium nitrate meant that potassium was an

uncontrolled variable. In her write-up she commented that investigations carried out by other members of her class suggested that the visible population growth rates of algae were far faster in the absence of the shrimps and that without the shrimps as consumers the environment for the algae became different quite quickly. As a suggestion for further work Student 4 wrote that she would like to look at the relationship between growth of algae and brine shrimp populations in relation to nitrate concentration, using sodium rather than potassium nitrate. She would have liked to have used the internet to find how high concentrations of nitrate had to be before causing actual eutrophication problems in streams and rivers and she intended to use this information in designing a follow up investigation.

Student 4 was a very able and enthusiastic student and the teacher had no hesitation in awarding full marks for each skill area, P8, O8, A8 and E6. Her class mate, Student 5, did his investigation on the effect of nitrate on the growth of brine shrimp populations both directly and indirectly. His write-up was much shorter than Student 4's yet he still achieved O8, A8 and E6 for a good piece of work. The reason his achievement in planning was restricted to P6 was because he did not use enough science to justify his predictions and that a little preliminary work might have been appropriate in order to decide on the range of treatments to use.

ECOLOGY NOTES FOR SCIENCE TEACHERS

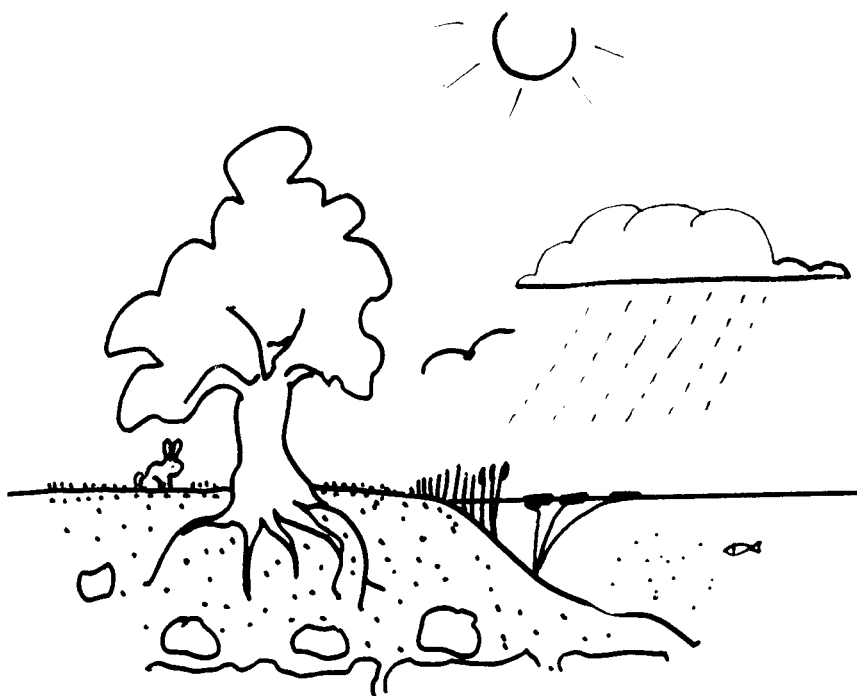

These notes should help teachers in their understanding of the science of ecology and work in support of teaching ecology to KS4. It also supports the use of the brine shrimp teaching material in this book. A bibliography (Section 5.3, pages 113-114) is appended to supply further study references on ecology and further detailed study of the brine shrimp *Artemia*.

- 1 Introducing ecosystems.
- 2 The brine shrimp ecosystem.
- 3 Energy flow, nutrient cycles and nutrient sinks.
- 4 Population ecology - boom and bust.
- 5 Pollution - water pollutants and harm to ecological systems.

1. Introducing ecosystems

Ecology is the study of the organisms in an area, together with the environmental influences that affect them. The physical and chemical properties of the deserts, mountains, forests, grasslands, lakes, rivers and seas vary. So too do the myriad of plants and animals that inhabit them. However, each local part of this planetary surface has an integration of its non-living and living things which together functions as an **ecosystem**.

The size of an ecosystem can vary, as will the components within it, yet each ecosystem has certain characteristics in common: the organisms interact with each other, energy flows through it and materials are cycled within it. Since the interactions

between the various elements in the ecosystem are very complex, those that have been investigated in detail have tended to be quite small.

Whatever the size of the ecosystem, it has three components:

- the green plants, algae or chemosynthetic prokaryotes, **the autotroph sub-system**, collectively called the primary producers
- the animals, and their parasites and predators, which feed on the autotrophs, **the heterotroph sub-system**, consisting of the primary consumers or herbivores and the secondary consumers or carnivores, etc.
- the organisms decomposing the remains of dead autotrophs and/or heterotrophs, **the decomposer sub-system**, commonly called scavengers, detritivores, or decomposers.

Ecosystems are self-sustaining, though they do require an input of **energy**. Green plants are able to utilise the energy of the Sun through **photosynthesis** and use it to synthesise complex organic compounds from simple inorganic substances. Green plants thus provide the energy which powers most ecosystems. The energy stored in the plant tissue is directly available for use by herbivores or, indirectly, by carnivores that eat herbivores. The total amount of plant material produced by autotrophs through photosynthesis is called **gross primary production**. However, a proportion of this is lost through plant respiration and so it is the remaining material, **the net primary production**, which is available to the heterotrophs. Net primary production varies widely from ecosystem to ecosystem, being low in deserts and tundra and highest in tropical rain forests and coral reefs.

In a terrestrial ecosystem, the plant material is available for **herbivores**, though of course much remains in storage in perennial plants and much dies to form the litter layer on the soil surface. The herbivores, in turn, are consumed by the **carnivores**. The herbivore and carnivore material will be available to **decomposers** and **detritivores**: the detritivores are heterotrophs that feed on decaying plant and animal material. Thus a one-way flow of energy moves through these feeding relationships. The quantity of available energy decreases along the chain from the plants to the decomposers (e.g. bacteria and fungi) and detritivores (e.g. earthworms and millipedes). As the amount of energy decreases, so does the number of organisms at each level in the chain. A diagram that is frequently used to show this numerical relationship is a **pyramid of numbers**. The pyramid usually has a broad base (the number of green plants), and then a declining number of, first herbivores and then carnivores. This is rather a simplified view, however, as it does not take into account the sizes of

the organisms. Thus a mature forest might have a relatively small number of primary producers (trees), whereas the same area of grassland would have a vast number of individual grass plants, yet the forest might support a larger number of herbivores and carnivores.

Apart from the energy, an ecosystem is sustained by **chemical elements**. These elements are in the soil, air, water and plant and animal tissues. These elements are the **mineral nutrients**. Unlike the energy flow, which is chain-like, the flow of nutrients is circular, being cycled around the various compartments in the ecosystem, over and over again. The nutrient reserves are mainly influenced by environmental inputs and by their re-cycling through the activities of decomposers and detritivores. Environmental inputs may enter an ecosystem from outside, through precipitation for example, or can be the product of rock weathering. Losses can also occur, for example, through leaching, evaporation or run-off. Environmental inputs are also influenced by human activity, e.g. through the application of fertilisers, pesticides and pollutants, and so the balance within an ecosystem can be upset.

2. The brine shrimp ecosystem

"I saw flamingoes here wading about in search of food - probably for worms - and these probably feed on infusoria and algae. Thus we have a little living world within itself, adapted to these inland lakes of brine".

Charles Darwin

from *The Journal of Researches* (1839) being Darwin's first observation of an Argentine salt lake, encountered by him, at the age of 24, during his formative 'Beagle' journey.

Brine shrimps are found throughout the warmer regions of the world, principally in the subtropics where seasonal salt pans occur. Such temporary lakes are often free of fish but do attract birds that feed on the zooplankton. Fish are very fond of brine shrimps if they can get them. The Great Salt Lake in Utah in the south west USA is one principal source of the *Artemia* used as commercial hatchery food in the culture of small fish. *Artemia* egg cysts collected from their dormant state on a dried salt pan are hatched and the nauplii (shrimp larvae) used to feed fish fry.

The classroom ecosystem which is being used in this project has its origins in one sample of sea water taken from a saltmarsh in Norfolk. Here the sea fills pools at the spring tides, which may not be re-filled for some time afterwards. For more than a decade this community of algae and micro-organisms has been used in tanks in the lab as a culture medium. This is probably not the only algal and microbial

source for the community. Brine shrimp egg cysts coming from Lake Utah, and purchased in any pet shop, also have a desiccated associated microflora attached to their surfaces. The eggs are thus not alone if introduced to a tank. In a medium of about 35 grams per litre sea salt this ecosystem has been found to function well and to be fully sustainable at minimal cost over a period of years.

High light intensity favours primary production. Tanks and bottles set up on window-sills thrive. The temperatures that are optimal for shrimps are sub-tropical, but although shrimps hatch best at 28° Celsius they will survive well at ten degrees less. In a warm and well lit classroom they may survive right through the year with no additional food input.

The algal producers in the tank ecosystem are of very many species. The most important prey of brine shrimps in their natural ecosystem are genera such as *Dunaliella*, *Tetraselmis* and *Isochrysis*. These are very small motile algae only a few micrometres in diameter. *Dunaliella* is probably the most common motile green alga, producing blooms of green unicells that swim to the light. This species goes an orange red colour (with β carotene) when the salt concentration gets high. Other algal producers are diatoms. Brine shrimps dislike the larger algal species with spiky silica skeletons. There are also nitrogen fixing cyanobacteria in cultures. All these algae respond by reproducing rapidly in raised levels of light, carbon dioxide and mineral nutrients. The latter may be added to the ecosystem with effect. Added nitrate at only a few parts per million or liquid fertiliser, such as that derived from large scale composting (e.g. *Baby Bio*), is found to have powerful effects. Doses of *Baby Bio* at one drop per litre per week will stimulate algal growth greatly provided that light levels allow for oxygenation of the water, through photosynthesis in the algae.

In a tank, with a bloom of algae followed by hatching of nauplii, there will be a rapid growth of the *Artemia* population. There is clear competition for food and the substantial net primary production of algae is rapidly passed on to the shrimps. So efficient are the shrimps at filter feeding the algae, that it is often unclear that the animals are removing primary producers from the water at a high rate.

In the natural ecosystem, the food resources from the algae are passed on through the shrimps to their predators. Because brine lakes and salt pans dry up totally on occasion they have no fish in them to be predators. Although fish will very readily eat brine shrimps, their natural predators are more likely to be birds, such as avocets and flamingoes.



In the tank ecosystem, as in the wild, shrimps invest enormously in egg cyst production. Released egg cysts collect at the surface and stick to the tank side. Individual shrimps die after some two months. They decay rapidly. Dead plant or animal material added to the tank also readily decays and so algal blooms may follow the death of shrimps. The microbial community of the ecosystem, consisting of aerobic and anaerobic bacteria, seems to be most important but it is difficult to study. Egg cyst hatching readily occurs in slightly alkaline, warm and oxygenated conditions. These correspond with fresh algal growth periods and so the population cycle resumes. Long term tanks of the shrimp ecosystem are best set up with an open top in a warm and well lit place. Keeping shrimps in the classroom has a proven attraction to students.

For school purposes many experiments may be done in discarded plastic drinks bottles. These are cheap and also water and gas tight. This keeps down the cost of experimental work.

Simulating a 'closed' ecosystem, along the lines of the US experimental 'BIOSPHERE 2', has its attraction to students also. If the brine shrimp ecosystem is totally closed in a plastic bottle it continues in good order for some months, provided it is lit. This illustrates the way in which respiratory gases and minerals are recycled.

After some months the bottle ecosystem, if closed to all outside influences but the light, slowly begins to run down. The atmosphere in the bottle seems to begin to build up organic gaseous components that are possibly toxic or nutrients go to a 'sink'. The algal regeneration slows, oxygen levels decline and the rate of microbial decay diminishes. Now, it may be observed that shrimp corpses fail to rot. Although egg cysts may hatch the algal system seems somehow unable to support them. The shrimps themselves seem tolerant of this pollution but the microbial system that supports them is not so resilient.

3. Energy flow, nutrient cycles and nutrient sinks

Energy and matter

Energy and matter are inextricably linked in ecology. In the *Introducing Ecosystems* notes (page 105) the key role of food chains was introduced. Food and respired oxygen are the vehicles through which energy and materials are brought to an animal. But we need to see more clearly how that energy and those elemental materials are functionally distinct from each other.

Energy enters ecosystems from the sunshine in the process of photosynthesis and is passed through food chains as material that is respired with oxygen. Energy cannot be created or destroyed but it may be transformed from one energy state into another. This is the **Law of Conservation of Energy**. Light energy becomes re-expressed as kinetic energy, potential energy, chemical bond energy, electrical energy, etc.. At every trophic (feeding) level, some of the energy transferred is put to some useful work by the organism but as this conversion happens much of the energy is not harnessed to do the required job but is dissipated in a more disordered and less useful form as heat. This is sometimes called the **Law of Entropy**. Every living thing gives off heat as it respire. So too do your brine shrimps, and their shrimp tank or bottle. The Earth itself is radiating back huge amounts of this more disordered heat energy into space.

A teacher of ecology needs to separate this energy transmission idea from the fact that the atoms themselves are not on such a one-way ticket but return again and again to different roles in metabolism. There is **cycling of elements**. Metabolism is the sum of building up (anabolic) reactions and breaking down (catabolic) reactions. We can follow the elemental cycles by looking at the source, routing, destination and final fate of each separate element. In developing this concept with students we are well advised to start this off with the **carbon cycle**, graduate to the **nitrogen cycle**, and then by extrapolation in student's minds see how the idea is extended to a generalisation. If you have

ever tried to draw an oxygen cycle you will know why it isn't in most text books!

Nutrient cycling in a shrimp bottle

If we partition the brine shrimp ecosystem into its smallest functional form we have a bottle ecosystem (see *Introduction* and *Student Activity 6*). This has all the elements of an ecosystem, **autotrophs**, **heterotrophs** and **decomposers** (see *Introducing ecosystems*, page 106).

The carbon cycle

Carbon dioxide is in the air of the bottle and dissolved as carbonic acid. Hydrogen carbonate ions are abundant in the water and are probably the form in which the algae will take up carbon. As light energy enters the bottle and the process of photosynthesis in the algae proceeds, carbohydrates such as sugars, starch and cellulose will be made, fats will also be synthesised. A typical alga can double its size and divide into two, about once a day. In this primary production, carbon is now fixed in a chemical molecular form by the autotrophic alga. The molecules are either structurally useful to the alga (cellulose or lipid membranes) or are stores of energy (starch and oil). Brine shrimps feed by filtering the water that they swim through, abstracting as many as half a million algal cells from about 100 cm³ of water each day. By digesting the algae, the molecules they contain are made small enough to enter their system and be utilised again, either as materials for building up the body or as energy stores that may be used to release energy for swimming and other activities. The shrimps respire much of the material that they eat and return carbon dioxide to the bottle. The carbon cycle here is short.

Students might be asked to imagine a shrimp bottle with no shrimps. If massive algal production takes place and the algae all die and fall to the bottom of the bottle one might see how under layers of sediment (and after millions of years of compression!) they might eventually form a fossil fuel such as oil.

The nitrogen cycle

The nitrogen cycle is more complex. Algae make use of nitrates in the water to synthesise nitrogen containing compounds in their cells. These are chemicals such as proteins, including all enzymes, and nucleic acids. Because, for an alga, these are such vital compounds, the growth of algae is often limited if a supply of nitrates is lacking. 'Available nitrogen', as it is often called, is frequently a limiting factor in algal growth. Nitrate levels in a shrimp tank may be assessed with nitrate testing strips (see page 99 of *The practical brine shrimp guide*). It will often be found that the nitrate levels are low. As soon as the algae are eaten, however, the algal proteins and DNA will be digested and reassembled into shrimp protein and DNA. Some of the algal

protein may be metabolised through deamination to release nitrogenous waste into the water. Here oxidative bacteria such as *Nitrosomonas* will convert the nitrites to nitrates and other bacteria such as *Nitrobacter* will oxidise these to nitrates. Once again the cycles here may be fast and short. In a brine shrimp ecosystem the animals will often become a population of large individuals within whose bodies many proteins are locked up. It is then not until these shrimps die and are fed upon by decomposers that their nitrogen is returned to the water. How then is there enough nitrogen? A steady source of decomposing plant or animal material is a good source, if small additions of nutrient fertiliser are not added on a regular basis. Blue-green coloured cyanobacteria are also present. These turn atmospheric nitrogen, also dissolved in the water, into ammonia and nitrates that algae can utilise. Although a bottle ecosystem is a tiny model it is undoubtedly most complex.

Other cycles and sinks

There are cycles for other important elements such as phosphorus (needed to make DNA and ATP), magnesium (needed to make chlorophyll), and sulphur (needed to make proteins). The bottle planet is too small to be sustainable for ever. This is illustrated by the fact that if you seal a bottle for some months and then re-open it the 'atmosphere', inside smells of sulphur containing gases. These gaseous sulphur compounds would, in the natural world, be broken down by the atmospheric radiation of ultra violet light and returned as sulphur dioxide in the rainfall. Where a mineral nutrient leaves the cycling process to become stationary for a long time between cycles we say that it is in a 'sink'. Phosphates are fairly insoluble and hence phosphorus is often adsorbed and

unavailable. Nitrogen has its sink in the atmosphere, where it is the most abundant gas. Carbon is, of course, well known to have its sink as fossil fuels. Removing carbon from this sink into the atmosphere as carbon dioxide is having an effect on the global ecosystem, as the gas itself stops that disordered heat energy from escaping into space.

Bottle ecosystems are intended as a beginner's guide to an understanding of ecosystem management!

4. Population ecology - boom and bust

A population is the group of organisms of a particular species that inhabit a geographical area at a particular time. One of the problems in identifying the bounds of a population is to determine the area that it covers. Sometimes this is fairly easy, for example, if the organisms are contained on an island or in woodland; but for some it is more difficult, for example, organisms in a river or a marine environment.

One of the characteristics of a population is that its size is subject to change, it is dynamic. Four variables cause the size of the population to vary: these are, for any one period of time, the number of births (**b**), deaths (**d**), the number emigrating (**e**) and the number immigrating (**i**).

Births and immigration cause the population to increase, deaths and emigration cause it to decrease. In a stable population, there is no population growth and $b + i = d + e$. If $b + i > d + e$ then the population increases; if $b + i < d + e$ the population decreases. For these equations to be meaningful, of course, these variables must be measured over the same period of time.

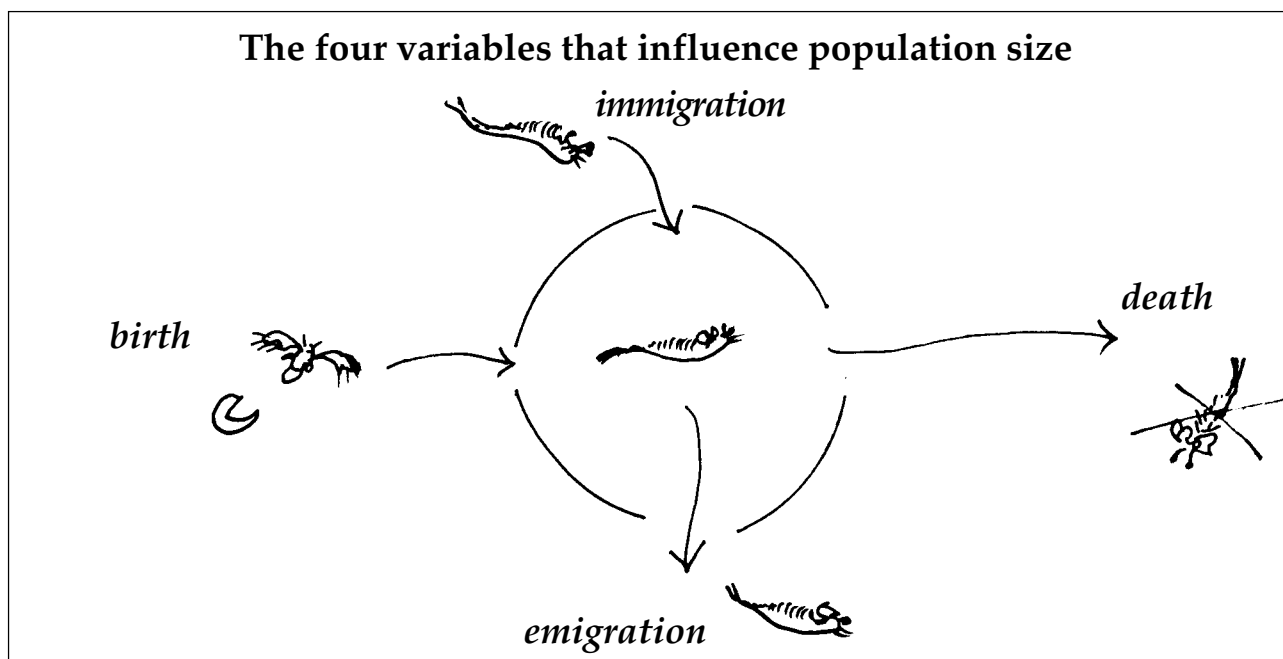

One way to try to visualise the effects that **b** and **d** have on a population is to construct a life table. The table indicates for a group of individuals produced at the same time (we call this the cohort) how many are alive at specific times in the future. From these data it is possible to construct survivorship curves. These curves indicate the number (or percentage) of surviving individuals of the original cohort over time. Such curves reveal the probability of dying. For many species there is usually a high mortality when the individuals are young, lower as they reach maturity, and then higher as the individuals age. Relative to mean life span, survivorship curves vary from species to species; that for a frog would be initially very steep, for a field mouse it would be initially less so.

For any population, there is potential for increase if the adults have the ability to produce offspring. If

rates of immigration and emigration are equal, growth rate depends on the initial population size, its age structure and the rate of reproduction. The lower the mortality and closer the initial population is to the age of maximum reproductive potential, the more rapid is the absolute growth. Under these circumstances, the birth rate is greater than the death rate: this difference is called the **rate of population increase (r)**. However, although such exponential growth may occur in the development of a population, it never continues for long because the requirements for growth begin to dwindle. One of the most obvious limitations on growth is food: as the available food diminishes, the growth in population levels off and, perhaps, eventually falls. For any particular environment, therefore, there is some upper limit to population growth, i.e. the environment can only support a certain number of

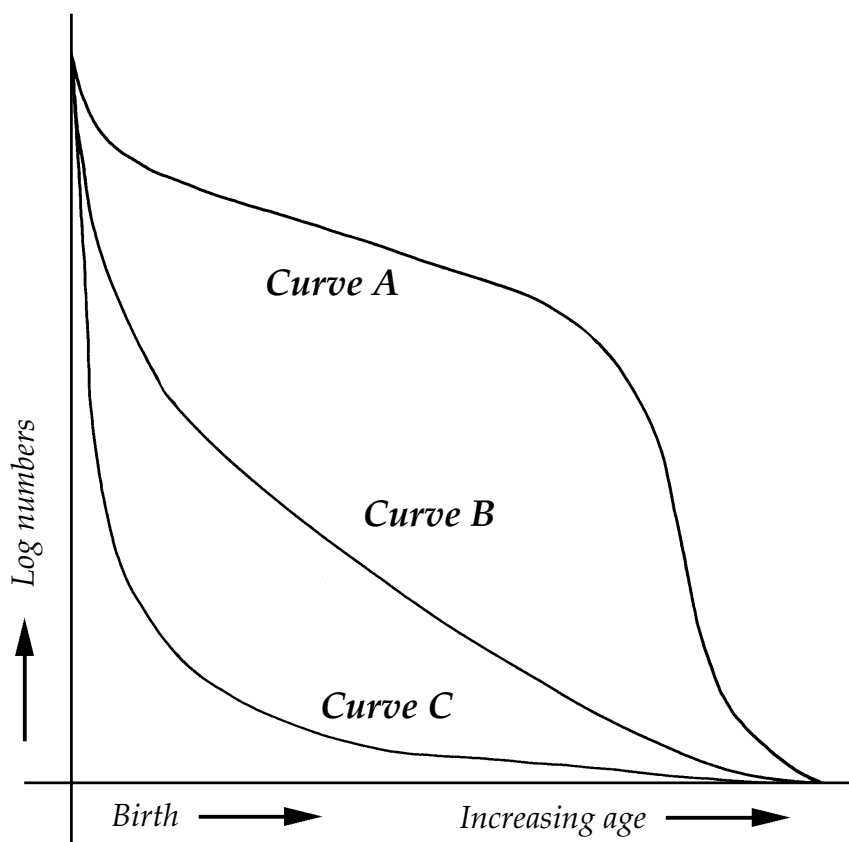

The three types of survivorship curve.

A Populations with curves like A have few offspring but those offspring that there are receive considerable parental care and have high survivorship throughout most of their life, though they have a high death rate in later years. This type of curve is typical of large mammals, such as ourselves.

B Populations with curves like B have a steady death rate throughout their life. This type of curve is typically found for small mammals, lizards and many birds, such as songbirds.

C Populations with curves like C have a high death rate in the early part of life which decreases with age. This type of curve is characteristic of invertebrates, fish and amphibians.

individuals. This number is termed the **carrying capacity (K)**. At the high population density, the carrying capacity sets limits by lowering the birth rate, by increasing the death rate or by increasing emigration or, of course, a combination of these. The carrying capacity is not constant but varies from year to year and from season to season.

Factors other than food also affect the carrying capacity of an environment. These can be water, space, pollution and the number of predators and parasites. Eventually one factor becomes limiting which checks population growth and acts to regulate the population. This does not mean that the population remains constant; typically it fluctuates around the carrying capacity. Occasionally, populations crash to very low numbers but rise again some time later to approach, and perhaps overshoot, the carrying capacity of the environment.

Three types of survivorship curve are generally found (see page 110). Organisms with survivorship curves like A produce only a few offspring at a time and the offspring are relatively large compared with the body mass of the parents, for example, cows and calves. Those animals with curves like C produce vast numbers of offspring at a time and the offspring are relatively small compared with the body mass of the adults, for example, cod. Survivorship curves are also influenced by the timing of reproduction and the number of offspring that the individuals produce at any time. Some organisms, for example Pacific salmon, reproduce very late in life and then die. Others, such as rabbits, reproduce at frequent intervals throughout their adult life.

The life history strategies that animals have evolved are often classified by ecologists as either **r-selected** or **K-selected**, where **r** is the rate of population increase and **K** is the carrying capacity of the environment.

r-selected organisms, such as frogs, can increase their population sizes very rapidly if conditions are favourable because they produce vast numbers of offspring. Sooner or later there will be severe mortality and often this is of the young (as in frog tadpoles). These organisms have survivorship curves like C.

K-selected organisms, such as eagles, are found in conditions that are relatively stable. They do not suffer from such high mortality as do r-selected populations. K-selected organisms have survivorship curves like A or B.

Although it is possible to envisage organisms as being r- or K-selected, in fact they are not discrete strategies, rather a spectrum of possibilities exists between the extremes of r and K. The former could be seen as going for quantity of offspring, rather than quality, whereas K-selected species opt for quality at the expense of quantity.

Brine shrimps are r-selected

Brine shrimps are found in regions of climatic variability. Furthermore, the variability is unpredictable. The checks on population growth are also not often density-dependent; thus if a lake dries out, all organisms are affected, irrespective of density. The size of a brine shrimp population is very variable and usually below the carrying capacity of the environment. The individuals are short-lived, living for weeks rather than months. The availability of food is unpredictable but when it is available food is usually abundant and hence competition for it will be weak. As with all r-selected species, brine shrimp individuals are small, reproduce when relatively young and have a great many offspring. The adults show no social grouping and do not display any parental care.

5. Pollution - water pollutants and harm to ecological systems

What is pollution?

Pollution occurs when a substance is introduced into an ecosystem in sufficient quantities to upset its balance and cause harm to the organisms within it. Of course, there are naturally occurring substances that are harmful - sulphur from volcanoes, for example, and the concentrations may be so high that plants are unable to grow. [Some sulphur, of course, is essential for plants and other organisms.] However, plants and animals which are tolerant of the particular harmful substance are often found near such a hazard and have adapted to it.

When we talk of pollution it is essentially a human activity. Humans are primarily responsible for adding many toxic substances to an ecosystem. The problems arise because not only are the concentrations of the pollutant too high for the ecosystem to absorb but the pollutant also tends to be introduced suddenly.

Domestic waste is rarely poisonous but industrial waste can be. Some waste products are harmful to aquatic organisms; some can be lethal to humans. An example of the latter was the Minimata Bay episode that occurred in Japan in the 1950s. Methyl mercury was part of the effluent discharged into the bay from an industrial plant and this led to the build up of mercury in fish living in the bay. Fish was an important part of the diet of the local people. It was not long before the effects of mercury poisoning were evident. In all, 62 human deaths were recorded.

There are a great many harmful substances that can be introduced into bodies of water. Aquatic organisms vary in their response to the pollutant. Algae are susceptible to copper and so copper can reduce the algal blooms that sometimes occur in

lakes, reservoirs and rivers. However, the major problem with such discharges is that the effects of the residues are cumulative. If an organism repeatedly eats affected animals the poisons can be concentrated in its tissues. If that organism, in turn, is eaten by another, then the concentrations can build up to levels which, if not lethal, can be harmful. The effects of DDT, an agricultural pesticide, have been well-documented and illustrate how these residues can build up in the food chain. If a particular example would be useful to use then the data in the study of DDT by Woodwell *et al.* (1967) illustrates the process particularly well (quoted in Anderson [1981] and other school texts). The consequences of such concentrations in the upper levels of food chains mean that top predators, such as birds of prey, may be killed or lay eggs with very thin shells. In the UK the decline of the peregrine falcon in the 1950s was attributed to the use of pesticides such as DDT and Dieldrin. Fortunately, the use of such pesticides is now severely restricted and the number of peregrines has risen to a level close to that of a century ago.

Animal waste from farms can be a problem in aquatic ecosystems. Animal excrement has the same effect on water as human excrement. Recent legislation has reduced the impact of animal excrement on rivers but it can still have an important, if local, effect on the water. This results in the deoxygenation of the water and in faunal changes. The sewage, on entering the water, stimulates bacterial and fungal growth and since these organisms require oxygen they deoxygenate it. [Of course, exactly the same effects, and problems, would occur with human sewage.]

Agricultural practices can also affect oxygen levels in water. The use of fertilisers on arable fields leads to phosphates and nitrates finding their way into the rivers through leaching from the soil and by surface run-off. The sudden increase in phosphate and nitrate in the water is termed eutrophication. Eutrophication affects the flora and fauna of the river. Perhaps the most obvious effect is an algal bloom. The algae and bacteria involved may colour the water, lead to the development of dense mats at the surface, which can smother the larger bottom-rooted plants, and deoxygenate the water. If the levels of phosphates and nitrates are limited then the grazing animals in the water, such as *Daphnia*, can keep the algae in check.

Effects of pollution on the brine shrimp ecosystem in the tank or bottle

In pollution research *Artemia*, the brine shrimp, has had extensive use as a test organism and is an acceptable alternative to the toxicity testing of mammals in the laboratory (Persoone and Wells 1987; Lewan, *et al.* 1992). The fact that millions of brine shrimps are so easily reared has been an

important help in assessing the effects of a large number of environmental pollutants on the shrimps under well controlled experimental conditions. Whilst not suggesting that such experiments are necessary or desirable in school biology they might be usefully discussed by students with their teachers (see *Data exercise 6*). They are one of the ways in which we can make predictions about the likely outcomes of environmental abuses.

Among the pollutants that have been researched are anti-fouling paints, used to coat the bottoms of boats to prevent another crustacean, the barnacle, from settling there. Anti-fouling paints contain the metal tin in an organic paint form as TBT (tri-butyl tin). Unfortunately persistent anti-fouling paints of this sort have been found to affect the sex ratios of some molluscs, such as whelks. Other heavy metals may have powerful environmental effects. Cadmium is one of these. Here only a few parts per billion (nanogrammes per litre) will have toxic effects. Interestingly, in this and other experiments with brine shrimps, a slow introductory exposure to the pollutant makes it easier for the animals to adapt to subsequently higher doses. Cadmium inhibits hatching but if removed allows development to proceed normally. It is not just the concentration of a pollutant that is important in assessing its effects but how slowly it is introduced to the environment and for how long it lasts. Algicides and aquatic herbicides have also been researched, and some of these have less toxic effects on the shrimps than upon the algae which support them.

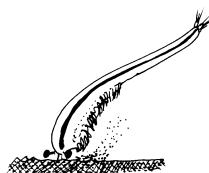

BIBLIOGRAPHY

GENERAL REFERENCES ON ECOLOGY

- Anderson, J. M. (1981) *Ecology for Environmental Sciences: Biosphere, Ecosystems and Man*. Edward Arnold, London.
- Chapman, J. L. and Reiss, M. J. (1998) *Ecology: Principles and Applications*. Cambridge University Press, Cambridge.
- Krebs, J. R. and Davies, N. B. (1997) *An Introduction to Behavioural Ecology (4th Edition)*. Blackwell, Oxford.
- Orton, R., Bebbington, A. and Bebbington, J. (1995) *Freshwater Invertebrates: a key to the invertebrates of ponds and streams*. Field Studies Council, Shrewsbury.

SELECTED REFERENCES TO RESEARCH PAPERS AND PUBLICATIONS ON THE ECOLOGY OF THE BRINE SHRIMP, *ARTEMIA*¹

There is a huge literature on *Artemia* on account of its commercial importance to the fish and larger shrimp rearing industries and the fact that *Artemia* is a major biological research animal. Much work centres on the Laboratory of Aquaculture & the *Artemia* Reference Center, at the University of Ghent, Rozier 44, B-9000 Ghent, Belgium, from which major publications have arisen e.g. Persoone (1980) 3 vols. and Sorgeloos (1987) 3 vols. The most recent major publication is Browne (1991).

- Amat, F. *et al.* Life history of an experimental Great Salt Lake *Artemia* population kept in outdoor culture. in Sorgeloos, P. *et al.* (1987) *Artemia Research and its Applications* Vol. 3. Universa Press, Wetteren, Belgium.
- Basil, J.A. *et al.* (1987) Preliminary studies on the culture of *Artemia* using renewable organic wastes. in Sorgeloos, P. *et al.* (1987) *Artemia Research and its Applications* Vol. 3. Universa Press, Wetteren, Belgium.
- Bradley, D.J. and Forward, R.B.Jr. (1984) Phototaxis of adult brine shrimp, *Artemia salina*. *Canadian Journal of Zoology*, **56**, 708-711.
- Browne, R. A. (1982) The costs of reproduction in brine shrimp. *Ecology*, **63** (1), 43-47.
- Browne, R.A. (1991) *Artemia Biology*. CRC Press Inc. Boca Raton, Florida, USA.
- Blust, R. A. *et al.* (1988) The effect of pH on the biological availability of copper to the brine shrimp *Artemia franciscana*. *Marine Biology*, **98**, 31-38.
- Cuellar, O. (1990) The ecology of brine shrimp from the Great Salt Lake Utah, USA. Branchiopoda, Anostraca. *Crustaceana*, **59**, 25-34.
- Cuellar, O. (1990) Some notes on the effects of low salinity on brine shrimp *Artemia salina* from Great Salt Lake Utah, USA. Branchiopoda, Anostraca. *Crustaceana*, **59**, 218-219.
- Cuellar, O. (1992) Some notes on the effects of high salinity on brine shrimp *Artemia salina* from Great Salt Lake Utah, USA. Branchiopoda, Anostraca. *Crustaceana*, **63**, 214-215.
- Dana, Gayle, L. *et al.* (1986) The effects of an increasing salinity on an *Artemia* population from Mono Lake, California. *Oecologia* (Berlin), **68**, 1428-436.
- Dana, Gayle, L. *et al.* (1993) Relationships between *Artemia monica* life history characteristics and salinity. *Hydrobiologia*, **263**, 129-143.

¹ Footnote on the classification of *Artemia*.

Artemia salina L. (as first described by Linnaeus in *Systema Naturae* in 1758) is the commonly used brine shrimp scientific name. However, the specific name *salina* is now widely regarded as being too generalised for accurate classification, for there are many different true species and races. Which species one has in culture depends upon the original salt lake source of egg cysts. Traditionally this has been from Lake Utah, but there are now other commercial sources of brine shrimp coming to Europe for the fish fry feeding trade. All *Artemia* are now regarded by taxonomists as one super-species within the one genus. There are five global groups of more closely related local

species. The *Artemia franciscana* group is found in the New World (Americas); this group includes *Artemia monica*, from Lake Mono, as well as *A. franciscana* from the Great Salt Lake, Utah. These New World forms are predominantly sexual and not parthenogenetic. The *Artemia tunisiana* group is found in Africa and the Mediterranean fringes of Europe. Some of these races are parthenogenetic, producing few males and numerous females that yield fertile eggs without mating. Three other species groups are found in the Middle East, *Artemia urmiana*, Eastern Asia, *Artemia sinica* and another group from Australia. For a recent taxonomic review see Browne and Bowen (1991) in Browne (1991) above.

- Eziefula, U. (1997) *pers. comm.* Undergraduate Special Study. Homerton College, Cambridge.
- Grosch, D.S. (1980) Alterations to the performance of *Artemia* caused by anti-fouling paints, algicides and an aquatic herbicide. in Persoone, G. *et al.* (1980) *The Brine shrimp Artemia*. Universa Press, Wetteren, Belgium.
- Herbst, D.B. and Dana, G.L. (1980) Environmental physiology of salt tolerance in an alkaline salt lake population of *Artemia* from Mono Lake, California, USA. in Persoone, G. *et al.* (1980) *The Brine shrimp Artemia*, Vol. 2. Universa Press, Wetteren, Belgium.
- Jenkin, P. (1957) The filter feeding and food of flamingoes. *Philosophical Transactions of the Royal Society B.*, **240**, 401-493.
- Lavens, P. and Sorgeloos, P. (1987) Design, operation and potential of a culture system for the continuous production of *Artemia* nauplii. in Sorgeloos, P. *et al.* (1987) *Artemia Research and its Applications*, Vol. 3. Universa Press, Wetteren, Belgium.
- Lewan, L., Andersson, M. and Moralesgomez P. (1992) The use of *Artemia salina* in toxicity testing. *Alternatives to Laboratory Animals*, **20**, 297-301.
- Lenz, P.H. (1987) Ecological studies on *Artemia*: a review. in Sorgeloos, P. *et al.* (1987) *Artemia Research and its Applications*, Vols. 1-3. Universa Press, Wetteren, Belgium.
- Leonhard, S.L. and Lawrence, S.G. (1980) The brine shrimp as a laboratory bioassay organism. 1. The effects of heavy metal cadmium on reproduction (abstract). 223-224. in Persoone, G. *et al.* (1980) *The Brine shrimp Artemia*. Universa Press, Wetteren, Belgium.
- Persoone, G. & Wells, P. G. (1987) *Artemia* in aquatic toxicology : a review in Sorgeloos, P. *et al.* *Artemia Research and its Applications*, Vol. 1. Universa Press, Wetteren, Belgium.
- Persoone, G. *et al.* (1980) *The brine shrimp Artemia* (Proceedings of the International Symposium on the brine shrimp *Artemia salina* in Texas in 1979), 3 Vols. Universa Press, Wetteren, Belgium.
- Planel, H., Gaubin, Y., Kaiser, R. and Pianezzi, B. (1980) *The effects of cosmic rays on Artemia egg cysts: Report for National Aeronautics and Space Administration*. Laboratoire Medicale, Faculté de Médecine, Toulouse, France.
- Schrehardt, A. (1987) A scanning electron microscope study of the post embryonic development of *Artemia* in Sorgeloos, P. *et al.* (1987) *Artemia Research and its Applications*, Vol. 1, Universa Press, Wetteren, Belgium.
- Simon, S.A. (1983) Locomotory activity of the brine shrimp *Artemia*. *Comp. Biochem. Physiol.* Vol. 75A, No 2, 193-199.
- Sorgeloos, P. *et al.* (1987) *Artemia Research and its Applications*, Vols. 1-3, Universa Press, Wetteren, Belgium.
- Triantaphyllidis, G.V. *et al.* (1995) Salinity effects on the survival, maturity, growth, biometrics, reproductive and lifespan characteristics of a bisexual and a parthenogenetic population of *Artemia*. *Hydrobiologia*, **302**, 215-227.
- Trieff, N.M. (1980) Toxicity of heavy metals, oils and other organics on *Artemia*, 253-262 in Persoone, G. *et al.* (1980) *The brine shrimp Artemia*. Universa Press, Wetteren, Belgium.
- Ward-Booth, K. and Reiss, M. (1988) *Artemia salina*: an easily cultured invertebrate ideally suited for ecological studies. *Journal of Biological Education*, **22**(4), 247-251.
- Williams, W.D. (1995) Inland lakes of brine: worlds within themselves. *Biologist*, **42**, 57-60.
- Wolfe, A.F. (1973) Observations on the clasping behaviour of *Artemia salina*. *Amer. Zool.*, **13**, 472.
- Wurtsbaugh, W.A. (1992) Food-web modification by an invertebrate predator in the Great Salt Lake, USA. *Oecologia*, **89**, 168-175.

REFERENCES TO WORLD WIDE WEB SITES

- | | |
|---|---|
| Photos and life history of <i>Artemia</i> | http://allserv.rug.ac.be/~booghe/james/courses/artemia/arc.htm |
| Laboratory of Aquaculture University of Ghent | http://www.rug.ac.be/aquaculture |
| <i>Artemia</i> WebGlimpse Search | http://allserv.rug.ac.be/~booghe/search.htm |
| Brine shrimp and ecology of the Great Salt Lake | http://www.dutslc.wr.usgs.gov/shrimp/shrimp.html |
| Commercial rearing of <i>Artemia</i> | http://www.aqualink.com/marine/z-atemia.html |
| Biosphere 2 - closed ecosystem research | http://www.colombia.edu/~alt12/Bio/bio2.html |