

IB Chemistry DP

15. HL Energetics / Thermochemistry

CONTENTS

15.1 Energy Cycles

15.1.1 Key Enthalpy Terms

15.1.2 Born-Haber Cycles

15.1.3 Born-Haber Cycle Calculations

15.1.4 Dissolution Energy Cycles

15.1.5 Energy Changes in Aqueous Solutions

15.2 Entropy & Spontaneity

15.2.1 Entropy

15.2.2 Calculating Entropy Change

15.2.3 Gibbs Free Energy

15.2.4 Spontaneous Reactions

15.2.5 Free Energy & Equilibrium

YOUR NOTES



15.1 Energy Cycles

15.1.1 Key Enthalpy Terms

YOUR NOTES



Key Enthalpy Terms

Ionisation energy

- The **ionisation energy** (ΔH_{IE}^{\ominus}) is the standard enthalpy change that occurs on the removal of 1 mole of electrons from 1 mole of gaseous atoms or positively charged ions
- Ionisation energy is always endothermic as energy is needed to overcome the attraction between an electron and the nucleus
- The **first ionisation energy** (ΔH_{IE1}^{\ominus}) is the energy required to remove one mole of electrons from 1 mole of gaseous atoms of an element to form 1 mole of 1+ ions in the gaseous phase



- The **second ionisation energy** (ΔH_{IE2}^{\ominus}) is the energy required to remove 1 mole of electrons from 1 mole of gaseous 1+ ions to form 1 mole of 2+ ions in the gaseous phase



Enthalpy of Atomisation

- The **enthalpy of atomisation** (ΔH_{at}^{\ominus}) is the standard enthalpy change that occurs on the formation of 1 mole of separate gaseous atoms from an element in its standard state
- The ΔH_{at}^{\ominus} is always **endothermic** as energy is always required to **break** any bonds between the atoms in the element or to break the element into its gaseous atoms
 - Since this is always an endothermic process, the enthalpy change will always have a **positive** value



Electron Affinity

- The **electron affinity** (ΔH_{EA}^{\ominus}) of an element is the energy change when 1 mole of electrons is gained by 1 mole of gaseous atoms of an element to form 1 mole of gaseous ions under standard conditions
- For example, the first electron affinity of chlorine is:



- The **first electron affinity** is always **exothermic** as energy is released when electrons are attracted to the atoms
- However, the **second electron affinity** of an element can be **endothermic** as illustrated by oxygen:



- This is because a large force of **repulsion** must be overcome between the negatively charged ion and the second electron requiring a large input of energy



Lattice Enthalpy

- The **lattice enthalpy** (ΔH_{lat}^{\ominus}) is defined as the standard enthalpy change that occurs on the formation of 1 mole of gaseous ions from the solid lattice
- The ΔH_{lat}^{\ominus} is always **endothermic** as energy is always required to **break** any bonds between the ions in the lattice
 - Since this is always an endothermic process, the enthalpy change will always have a **positive** value



Enthalpy of Solution

- The **standard enthalpy change of solution** (ΔH_{sol}^{\ominus}) is the enthalpy change when 1 mole of an ionic substance **dissolves** in sufficient water to form an **infinitely dilute solution**
- The symbol **(aq)** is used to show that the solid is dissolved in **sufficient water**
- ΔH_{sol}^{\ominus} can be **exothermic** (negative) or **endothermic** (positive)



Enthalpy of Hydration

- The **standard enthalpy change of hydration** (ΔH_{hyd}^{\ominus}) is the enthalpy change when 1 mole of a specified **gaseous ion** dissolves in sufficient water to form an infinitely dilute **solution**



- Hydration enthalpies are the measure of the energy that is released when there is an attraction formed between the ions and water molecules
- Hydration enthalpies are **exothermic**
- The term **solvation** is used in place of hydration if water has been replaced by another solvent
- When an **ionic solid** dissolves in water, positive and negative ions are formed
- Water is a **polar** molecule with a δ^- - oxygen (O) atom and δ^+ hydrogen (H) atoms which will form **ion-dipole attractions** with the ions present in the solution
- The oxygen atom in water will be attracted to the **positive ions** and the hydrogen atoms will be attracted to the **negative ions**

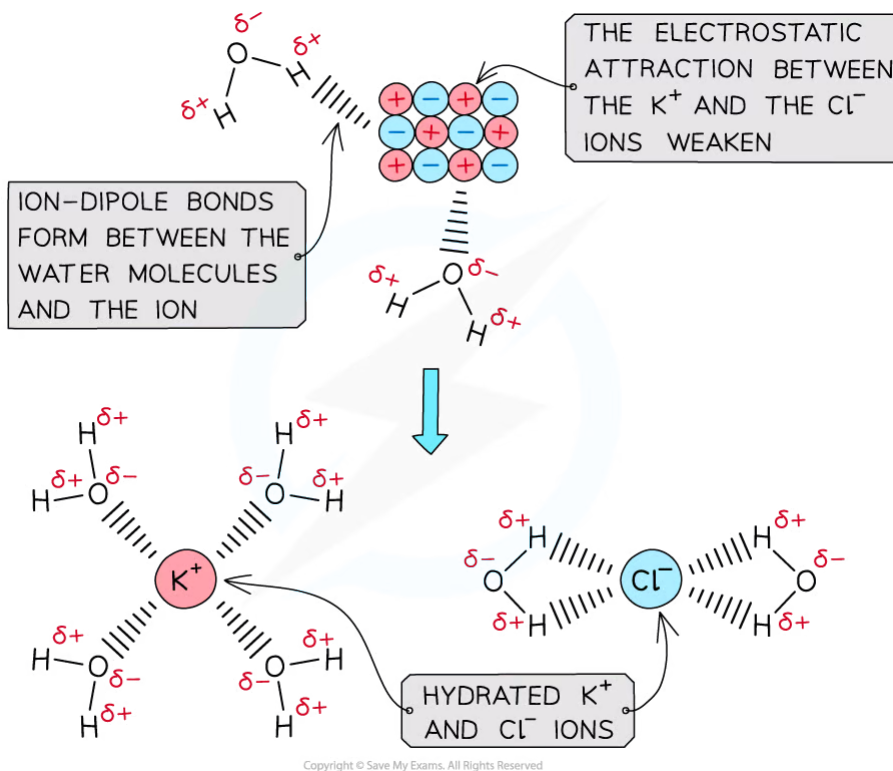

The polar water molecules will form ion-dipole bonds with the ions in solution causing the ions to become hydrated

YOUR NOTES



15.1.2 Born-Haber Cycles

YOUR NOTES



Constructing Born-Haber Cycles

- A **Born-Haber cycle** is a specific application of **Hess's Law** for ionic compounds and enables us to calculate lattice enthalpy, which cannot be found by experiment
- The basic principle of drawing the cycle is to construct a diagram in which energy increases going up the diagram

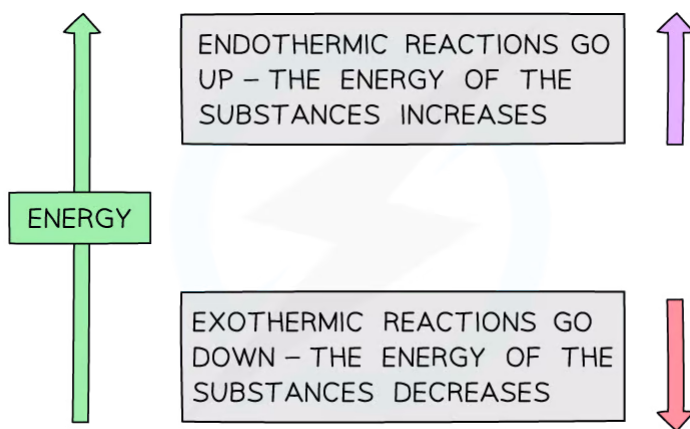

The basic principle of a Born-Haber cycle

- The cycle shows all the steps needed to turn atoms into gaseous ions and from gaseous ions into the ionic lattice
- The alternative route to the ionic lattice begins from the enthalpy of formation of the elements in their standard states

Drawing the cycle for sodium chloride

- A good starting point is to draw the elements with their state symbols about a third of the way up the diagram
- This is shown as the left hand side of the equation for the process indicated
- The location is marked by drawing a horizontal bar or line which represents the starting energy level

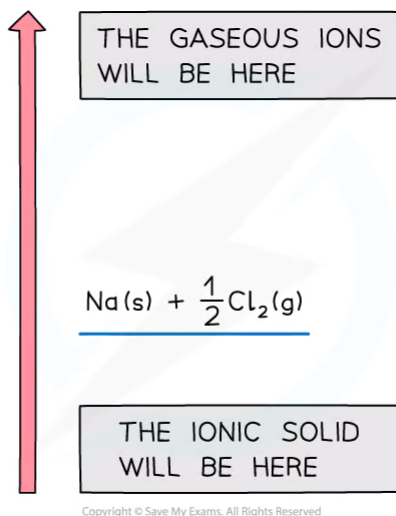

Drawing a Born-Haber cycle step 1

- Next, we need to create the gaseous ions
- This is a two step process of first creating the gaseous atoms and then turning them into ions
- Creating gaseous atoms is a bond breaking process, so arrows must be drawn upwards
- It doesn't matter whether you start with sodium or chlorine
- The enthalpy of atomisation of sodium is



- The enthalpy of atomisation of chlorine is



- We can show the products of the process on the horizontal lines and the energy value against a vertical arrow connecting the energy levels

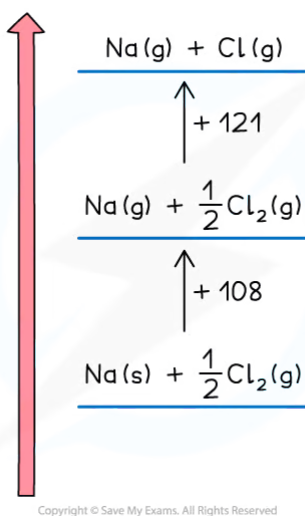

Drawing a Born-Haber cycle step 2 – creating the gaseous atoms



- Now that the ions are created:
- The sodium ion loses an electron, so this energy change is the first ionisation energy for sodium



- The change is endothermic so the direction continues upwards
- The chlorine atom gains an electron, so this is electron affinity



- The exothermic change means this is downwards
- The change is displaced to the right to make the diagram easier to read

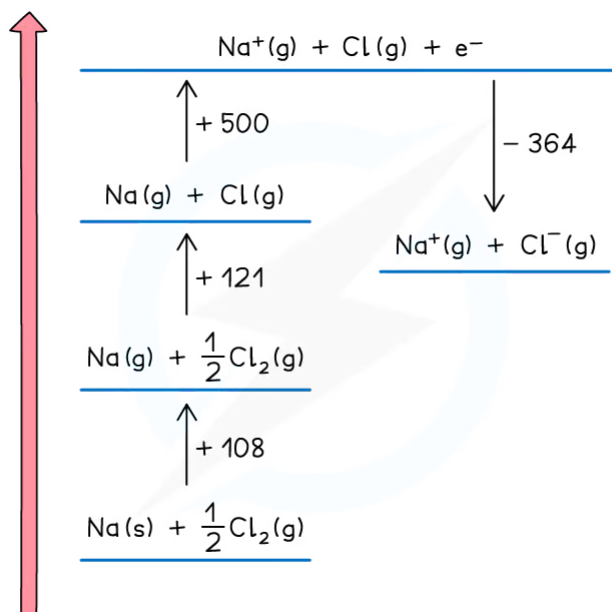

Drawing a Born-Haber cycle step 3 – creating the gaseous ions

- The two remaining parts of the cycle can now be completed
- The enthalpy of formation of sodium chloride is added at the bottom of the diagram

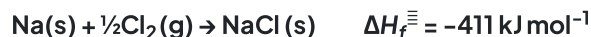

- This is an exothermic change for sodium chloride so the arrow points downwards
- Enthalpy of formation can be exothermic or endothermic, so you may need to show it above the elements (and displaced to the right) for an endothermic change
- The final change is lattice enthalpy, which is usually shown as formation. For sodium chloride, the equation is

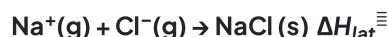

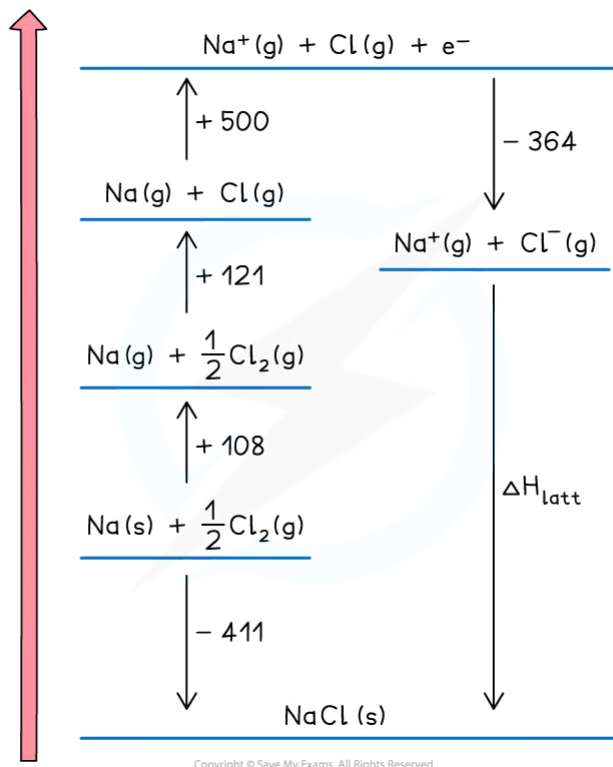

Drawing a Born-Haber cycle step 4 – completing the cycle

- The cycle is now complete
- The cycle is usually used to calculate the lattice enthalpy of an ionic solid, but can be used to find other enthalpy changes if you are given the lattice enthalpy

YOUR NOTES





Worked Example

Constructing a Born-Haber cycle for KCl Construct a Born-Haber Cycle which can be used to calculate the lattice energy of potassium chloride.

Step	Equation	Enthalpy Change
Convert K(s) atoms into K(g) atoms	$\text{K(s)} \longrightarrow \text{K(g)}$	$\Delta H_{\text{at}}^{\ominus}$
Convert K(g) atoms into K ⁺ (g) ions	$\text{K(g)} \longrightarrow \text{K}^{+}(\text{g}) + \text{e}^{-}$	IE_1
Convert Cl ₂ (g) molecules into Cl(g) atoms	$\frac{1}{2} \text{Cl}_2(\text{g}) \longrightarrow \text{Cl(g)}$	$\Delta H_{\text{at}}^{\ominus}$
Convert Cl(g) atoms into Cl ⁻ (g) ions	$\text{Cl(g)} + \text{e}^{-} \longrightarrow \text{Cl}^{-}(\text{g})$	EA_1
Add up all values to get ΔH_1^{\ominus}		ΔH_1^{\ominus}
Apply Hess's Law to find $\Delta H_{\text{latt}}^{\ominus}$		$\Delta H_{\text{latt}}^{\ominus}$

Copyright © Save My Exams. All Rights Reserved

Answer

YOUR NOTES

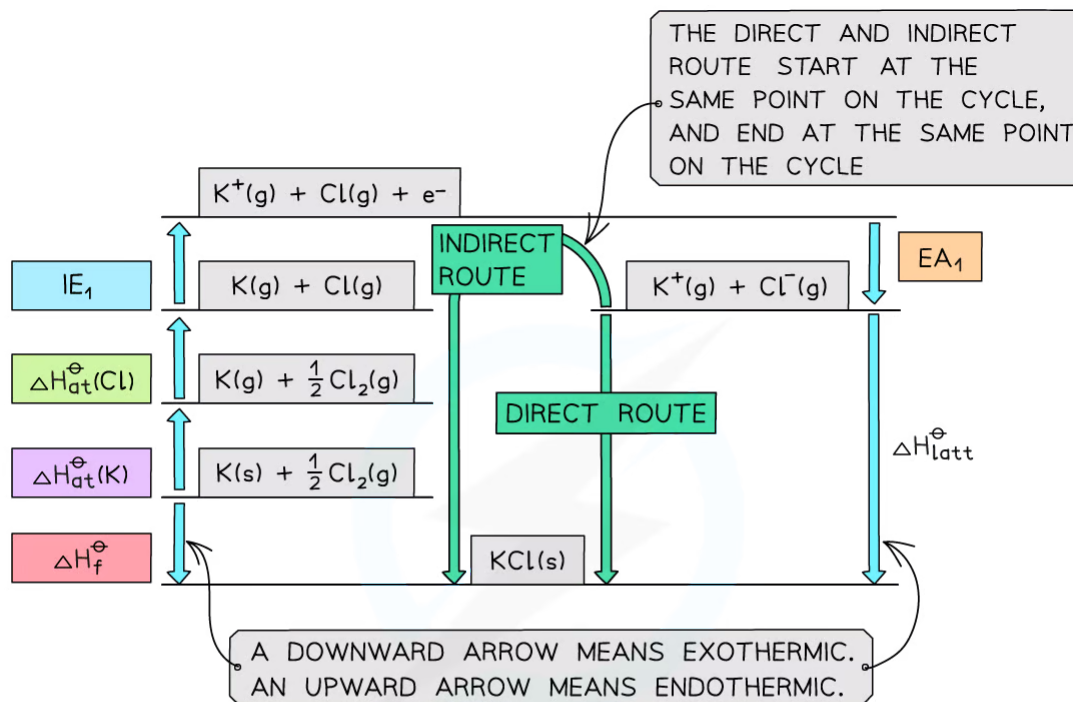

$$\Delta H_f^\ominus = (\Delta H_{\text{at}}^\ominus(\text{K})) + (\Delta H_{\text{at}}^\ominus(\text{Cl})) + (\text{IE}_1) + (\text{EA}_1) + (\Delta H_{\text{latt}}^\ominus)$$

$$\therefore \Delta H_{\text{latt}}^\ominus = (\Delta H_f^\ominus) - (\text{EA}_1) - (\text{IE}_1) - (\Delta H_{\text{at}}^\ominus(\text{Cl})) - (\Delta H_{\text{at}}^\ominus(\text{K}))$$

ΔH_1^\ominus

Copyright © Save My Exams. All Rights Reserved



Worked Example

Constructing a Born-Haber cycle for MgO Construct a Born-Haber Cycle which can be used to calculate the lattice energy of magnesium oxide.

Step	Equation	Enthalpy Change
Convert Mg(s) atoms into Mg(g) atoms	$\text{Mg(s)} \longrightarrow \text{Mg(g)}$	$\Delta H_{\text{at}}^{\ominus}$
Convert Mg(g) atoms into Mg ⁺ (g) ions	$\text{Mg(g)} \longrightarrow \text{Mg}^{\text{+}}(\text{g}) + \text{e}^{-}$	IE_1
Convert Mg ⁺ (g) ions into Mg ²⁺ (g) ions	$\text{Mg}^{\text{+}}(\text{g}) \longrightarrow \text{Mg}^{\text{2+}}(\text{g}) + \text{e}^{-}$	IE_2
Convert O ₂ (g) molecules into O(g) atoms	$\frac{1}{2}\text{O}_2(\text{g}) \longrightarrow \text{O(g)}$	$\Delta H_{\text{at}}^{\ominus}$
Convert O(g) atoms into O ⁻ (g) ions	$\text{O(g)} + \text{e}^{-} \longrightarrow \text{O}^{-}(\text{g})$	EA_1
Convert O ⁻ (g) ions into O ²⁻ (g) ions	$\text{O}^{-}(\text{g}) + \text{e}^{-} \longrightarrow \text{O}^{\text{2-}}(\text{g})$	EA_2
Add up all values to get ΔH_1^{\ominus}		ΔH_1^{\ominus}
Apply Hess's Law to find $\Delta H_{\text{latt}}^{\ominus}$		$\Delta H_{\text{latt}}^{\ominus}$

Copyright © Save My Exams. All Rights Reserved

Answer

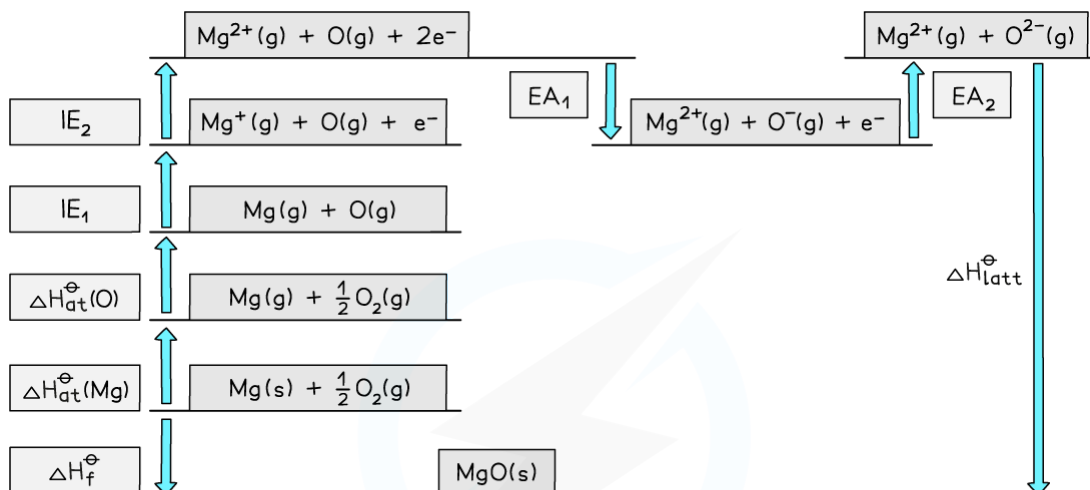

YOUR NOTES



$$\Delta H_f^\ominus = \left(\Delta H_{\text{at}}^\ominus(\text{Mg}) \right) + \left(\Delta H_{\text{at}}^\ominus(\text{O}) \right) + \left(\text{IE}_1 \right) + \left(\text{IE}_2 \right) + \left(\text{EA}_1 \right) + \left(\text{EA}_2 \right) + \left(\Delta H_{\text{latt}}^\ominus \right)$$

$$\therefore \Delta H_{\text{latt}}^\ominus = \left(\Delta H_f^\ominus \right) - \underbrace{\left(\text{EA}_1 \right) - \left(\text{EA}_2 \right) - \left(\text{IE}_1 \right) - \left(\text{IE}_2 \right) - \left(\Delta H_{\text{at}}^\ominus(\text{Mg}) \right) - \left(\Delta H_{\text{at}}^\ominus(\text{O}) \right)}_{\Delta H_1^\ominus}$$

Copyright © Save My Exams. All Rights Reserved



Exam Tip

When constructing Born-Haber cycles, the direction of the changes is important, but the relative size of the steps does not matter so don't worry if the steps don't correspond to the magnitude of the energy changes. You don't need to show the energy axis in a Born-Haber cycle, but you do need to show the electron(s) in the ionisation step otherwise you might lose marks in an exam.

15.1.3 Born-Haber Cycle Calculations

YOUR NOTES



Born-Haber Cycle Calculations

- Once a Born-Haber cycle has been constructed, it is possible to calculate the lattice energy (ΔH_{lat}^{\ominus}) by applying Hess's law and rearranging:

$$\Delta H_f^{\ominus} = \Delta H_{at}^{\ominus} + \Delta H_{at}^{\ominus} + IE + EA + \Delta H_{lat}^{\ominus}$$

- If we simplify this into three terms, this makes the equation easier to see:
 - ΔH_{lat}^{\ominus}
 - ΔH_f^{\ominus}
 - ΔH_1^{\ominus} (the sum of all of the various enthalpy changes necessary to convert the elements in their standard states to gaseous ions)
- The simplified equation becomes:

$$\Delta H_f^{\ominus} = \Delta H_1^{\ominus} + \Delta H_{lat}^{\ominus}$$

- So, if we rearrange to calculate the lattice energy, the equation becomes

$$\Delta H_{lat}^{\ominus} = \Delta H_f^{\ominus} - \Delta H_1^{\ominus}$$

- When calculating the ΔH_{lat}^{\ominus} , all other necessary values will be given in the question
- A Born-Haber cycle could be used to calculate any stage in the cycle
 - For example, you could be given the lattice energy and asked to calculate the enthalpy change of formation of the ionic compound
 - The principle would be exactly the same
 - Work out the **direct** and **indirect route** of the cycle (the stage that you are being asked to calculate will always be the direct route)
 - Write out the equation in terms of enthalpy changes and rearrange if necessary to calculate the required value
- Remember:** sometimes a value may need to be doubled or halved, depending on the ionic solid involved
 - For example, with MgCl_2 the value for the first electron affinity of chlorine would need to be doubled in the calculation, because there are two moles of chlorine atoms
 - Therefore, you are adding **2 moles** of electrons to **2 moles** of chlorine atoms, to form **2 moles** of chloride ions, i.e. 2Cl^-



Worked Example

Calculating the lattice energy of KCl Given the data below, calculate the ΔH_{lat}^{\ominus} of potassium chloride (KCl)

	ΔH_{at}^{\ominus} (kJ mol ⁻¹)	IE/EA (kJ mol ⁻¹)
K	+90	+418
Cl	+122	-349
ΔH_f^{\ominus} (kJ mol ⁻¹)		
KCl	-437	

Copyright © Save My Exams. All Rights Reserved

YOUR NOTES



Answer

Step 1: Construct the Born-Haber cycle

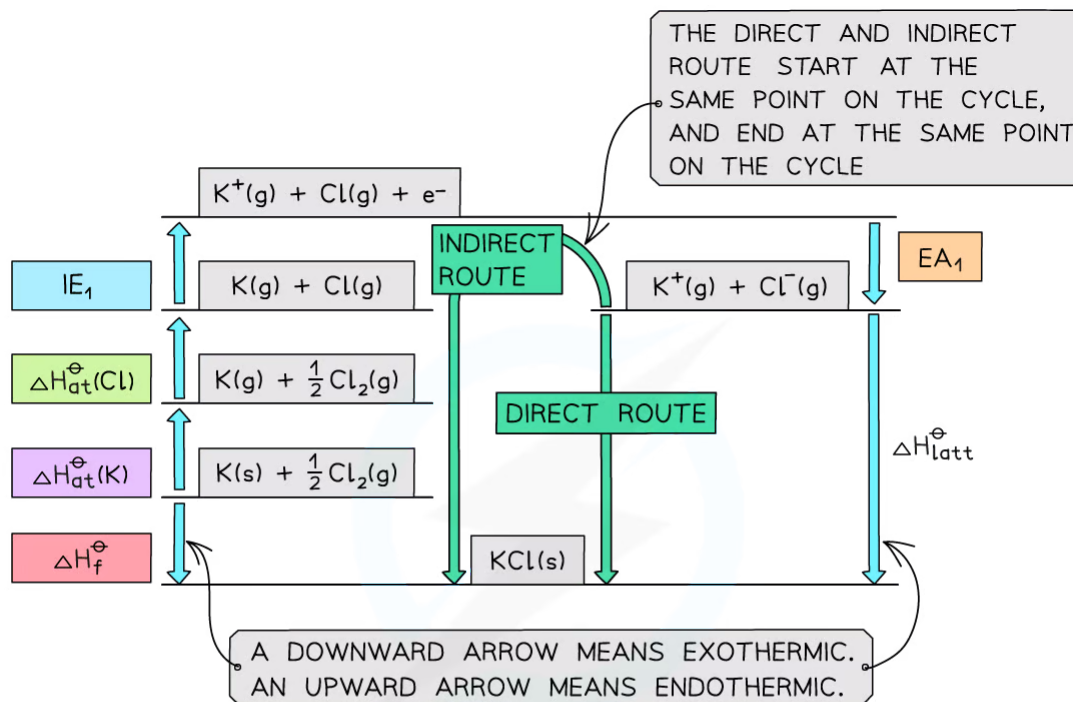

$$\Delta H_f^\ominus = (\Delta H_{at}^\ominus(K)) + (\Delta H_{at}^\ominus(Cl)) + (IE_1) + (EA_1) + (\Delta H_{latt}^\ominus)$$

$$\therefore \Delta H_{latt}^\ominus = (\Delta H_f^\ominus) - \underbrace{[(EA_1) + (IE_1) + (\Delta H_{at}^\ominus(Cl)) + (\Delta H_{at}^\ominus(K))]}_{\Delta H_1^\ominus}$$

Copyright © Save My Exams. All Rights Reserved

Step 2: Applying Hess' law, the lattice energy of KCl is:

$$\Delta H_{lat}^{\ominus} = \Delta H_f^{\ominus} - \Delta H_1^{\ominus}$$

$$\Delta H_{latt}^{\ominus} = \Delta H_f^{\ominus} - [(\Delta H_{at}^{\ominus} K) + (\Delta H_{at}^{\ominus} Cl) + (IE_1 K) + (EA_1 Cl)]$$

Step 3: Substitute in the numbers:

$$\Delta H_{lat}^{\ominus} = (-437) - [(+90) + (+122) + (+418) + (-349)] = -718 \text{ kJ mol}^{-1}$$



? Worked Example

Calculating the lattice energy of MgO Given the data below, calculate the ΔH_{lat}^{\ominus} of magnesium oxide (MgO)

	ΔH_{at}^{\ominus} (kJ mol ⁻¹)	IE_1/EA_1 (kJ mol ⁻¹)	IE_2/EA_2 (kJ mol ⁻¹)
Mg	+148	+736	+1450
O	+248	-142	+770
ΔH_f^{\ominus} (kJ mol ⁻¹)			
MgO	-602		

Copyright © Save My Exams. All Rights Reserved

Answer

Step 1: Construct the Born-Haber cycle

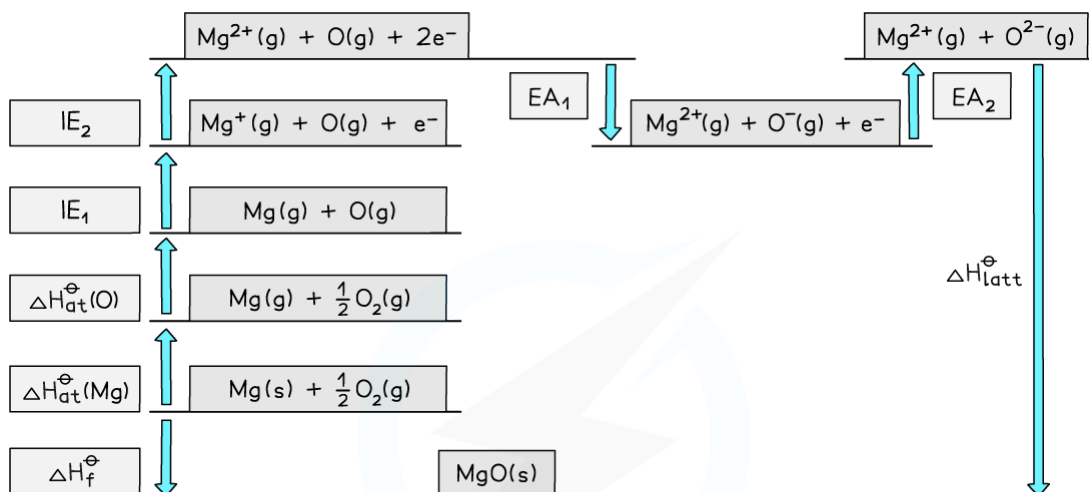

$$\Delta H_f^{\ominus} = (\Delta H_{at}^{\ominus}(\text{Mg})) + (\Delta H_{at}^{\ominus}(\text{O})) + (IE_1) + (IE_2) + (EA_1) + (EA_2) + (\Delta H_{latt}^{\ominus})$$

$$\therefore \Delta H_{latt}^{\ominus} = (\Delta H_f^{\ominus}) - \underbrace{(EA_1) - (EA_2) - (IE_1) - (IE_2) - (\Delta H_{at}^{\ominus}(\text{Mg})) - (\Delta H_{at}^{\ominus}(\text{O}))}_{\Delta H_1^{\ominus}}$$

Copyright © Save My Exams. All Rights Reserved

Step 2: Applying Hess' law, the lattice energy of MgO is:

$$\Delta H_{latt}^{\ominus} = \Delta H_f^{\ominus} - \Delta H_1^{\ominus}$$

$$\Delta H_{latt}^{\ominus} = \Delta H_f^{\ominus} - [(\Delta H_{at}^{\ominus} \text{ Mg}) + (\Delta H_{at}^{\ominus} \text{ O}) + (IE_1 \text{ Mg}) + (IE_2 \text{ Mg}) + (EA_1 \text{ O}) + (EA_2 \text{ O})]$$

Step 3: Substitute in the numbers:

$$\begin{aligned}\Delta H_{\text{lat}}^{\ominus} &= (-602) - [(+148) + (+248) + (+736) + (+1450) + (-142) + (+770)] \\ &= -3812 \text{ kJ mol}^{-1}\end{aligned}$$

YOUR NOTES



Size & Charge of Ions & Lattice Enthalpy

YOUR NOTES



Factors affecting lattice enthalpy

- The two key factors which affect lattice energy, ΔH_{lat}^{\ominus} , are the **ionic charge** and **ionic radii** of the ions that make up the **crystalline lattice**

Ionic Radius

- The radius of the anion increases as you move down a group
- As the distance between the bonded ions increases, the strength of the electrostatic attraction decreases
- This is reflected by a decrease in the lattice enthalpy
- The lattice enthalpy becomes **more negative** or **more exothermic** as the ionic radius of the ions increases
- This is because the charge on the ions is more spread out over the ion when the ions are larger
- The ions are also further apart from each other in the lattice
 - The attraction between ions is between the centres of the ions involved, so the bigger the ions the bigger the distance between the centre of the ions
- Therefore, the **electrostatic forces of attraction** between the oppositely charged ions in the lattice are weaker
- For example, down group 17, the ionic radii increases which directly influences the lattice enthalpy

Lattice enthalpies of sodium halides

Sodium Halide	Theoretical value ΔH_{lat}^{\ominus} (kJ mol^{-1})
NaF	930
NaCl	790
NaBr	754
NaI	705

Copyright © Save My Exams. All Rights Reserved

Ionic Charge

- Increasing the ionic charge will result in an increased attraction between oppositely charged ions
- This will increase the energy required to break the lattice apart, and therefore increase the lattice enthalpy (becomes **more positive** or **more endothermic**)
- The greater the ionic charge, the higher the charge density
- This results in **stronger electrostatic attraction** between the oppositely charged ions in the lattice
- As a result, the lattice enthalpy is more endothermic
 - For example, the lattice energy of calcium oxide (CaO) is more endothermic than the lattice energy of potassium chloride (KCl)

Lattice enthalpies with varying ionic charges and radii

Compound	Theoretical value $\Delta H_{\text{lat}}^{\ominus}$ (kJ mol^{-1})	Variation
KI	650	Increase in ionic radius
NaCl	790	–
CaO	3401	Increase in ionic charge

Copyright © Save My Exams. All Rights Reserved

Exam Tip

The answers for these calculations are given as negative values, which shows they are exothermic. We discussed earlier that values for lattice enthalpy are positive values as the lattice is being broken. Essentially this is lattice dissociation enthalpy and is an endothermic process. Lattice formation enthalpy will give a negative value which has been calculated using the Born-Haber cycles. This gives us the energy released when a lattice is formed from its scattered gaseous ions.

YOUR NOTES



15.1.4 Dissolution Energy Cycles

YOUR NOTES



Dissolution Energy Cycles

How are enthalpy of solution and hydration enthalpies related?

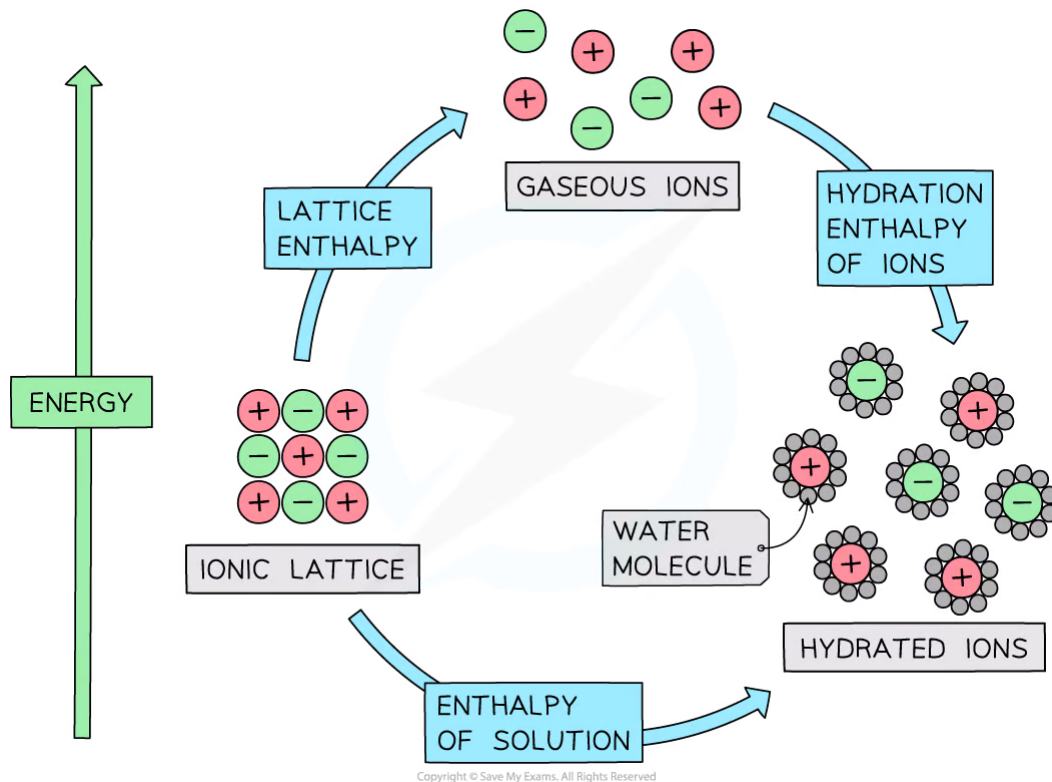

The relationship between lattice enthalpy, hydration enthalpies and enthalpy of solution

- From the diagram we can see that the relationship is

$$\text{Enthalpy of solution} = \text{lattice enthalpy} + \text{hydration enthalpy}$$

- The hydration enthalpy is the **sum** of the hydration enthalpies of each ion
- If there is more than one cation or anion, such as in MgCl_2 , then you must multiply by the appropriate coefficient for that ion

Calculations from Dissolution Cycles

- In order to calculate either $\Delta H_{\text{sol}}^{\ominus}$, $\Delta H_{\text{lat}}^{\ominus}$ or $\Delta H_{\text{hyd}}^{\ominus}$ from given data we must apply **Hess's Law**

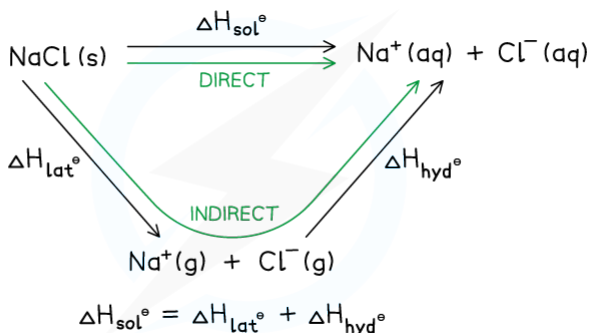

Copyright © Save My Exams. All Rights Reserved

Energy cycle showing the application of Hess's Law to sodium chloride

- The energy cycle shows that there are two routes to go from the gaseous ions to the ions in an aqueous solution:
 - Route 1:** going from ionic solid → ions in the gaseous phase → ions in aqueous solution (this is the **indirect route**)
 - Route 2:** going from ionic solid → ions in aqueous solution (this is the **direct route**)
- According to Hess's law, the enthalpy change for both routes is the same, such that:

$$\Delta H_{\text{sol}}^{\ominus} = \Delta H_{\text{lat}}^{\ominus} + \Delta H_{\text{hyd}}^{\ominus}$$

- Each ion will have its own enthalpy change of hydration, $\Delta H_{\text{hyd}}^{\ominus}$, which will need to be taken into account during calculations
 - The hydration enthalpy is the **sum** of the hydration enthalpies of each ion
 - The total $\Delta H_{\text{hyd}}^{\ominus}$ is found by adding the $\Delta H_{\text{hyd}}^{\ominus}$ values of both anions and cations together
 - If there is more than one cation or anion, such as in MgCl_2 , then you must multiply by the appropriate coefficient for that ion
- This can also be represented as a **Born-Haber** cycle with the same direct and indirect route

YOUR NOTES



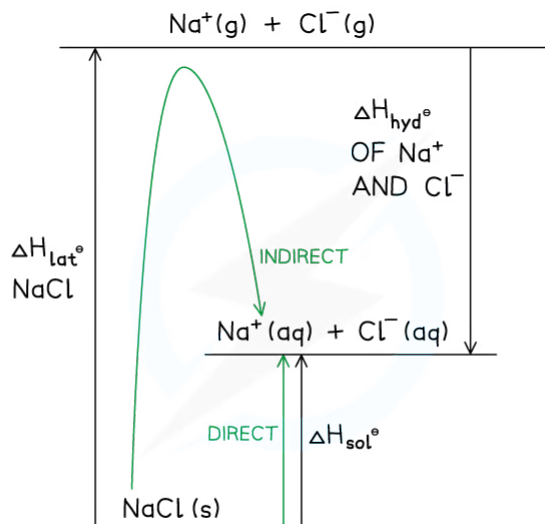

$$\Delta H_{\text{sol}}^\circ = \Delta H_{\text{lat}}^\circ + \Delta H_{\text{hyd}}^\circ$$

Copyright © Save My Exams. All Rights Reserved

Born-Haber cycle for sodium chloride

? Worked Example

Calculate the enthalpy change of solution $\Delta H_{\text{sol}}^\circ$ of calcium fluoride, CaF_2 using the following data:

- $\Delta H_{\text{lat}}^\circ \text{CaF}_2 = +2651 \text{ kJ mol}^{-1}$
- $\Delta H_{\text{hyd}}^\circ \text{Ca}^{2+} = -1616 \text{ kJ mol}^{-1}$
- $\Delta H_{\text{hyd}}^\circ \text{F}^- = -504 \text{ kJ mol}^{-1}$

Answer:

Option 1 - Drawn as a Hess's Law cycle:

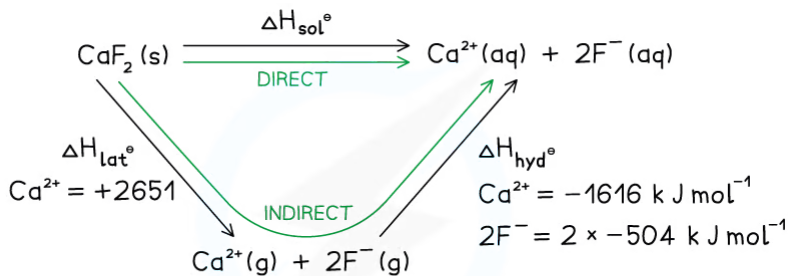

$$\begin{aligned} \Delta H_{\text{sol}}^\circ &= \Delta H_{\text{lat}}^\circ + \Delta H_{\text{hyd}}^\circ \\ &= +2651 + (-1616) + (2 \times -504) \\ &= +27 \text{ kJ mol}^{-1} \end{aligned}$$

Copyright © Save My Exams. All Rights Reserved

CaF₂ Hess's Law Cycle



It is possible to complete this question by drawing a Born-Haber cycle, but examiners see mistakes more often on hydration and solution enthalpy questions when they are completed using a Born-Haber cycle.

Option 2 – Drawn as a Born-Haber cycle:

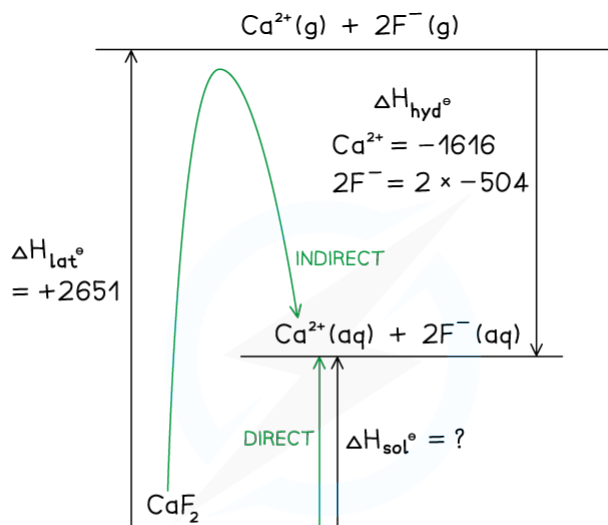

$$\begin{aligned} \Delta H_{\text{sol}}^{\circ} &= \Delta H_{\text{lat}}^{\circ} + \Delta H_{\text{hyd}}^{\circ} \\ &= +2651 + (-1616) + (2 \times -504) \\ &= +27 \text{ kJ mol}^{-1} \end{aligned}$$

Copyright © Save My Exams. All Rights Reserved

CaF₂ B-H cycle



Worked Example

Calculate the value of the enthalpy of hydration, $\Delta H_{\text{hyd}}^{\ominus}$, for the NH_4^+ ion using the following data:

- $\Delta H_{\text{lat}}^{\ominus} \text{NH}_4\text{Cl} = +705 \text{ kJ mol}^{-1}$
- $\Delta H_{\text{sol}}^{\ominus} \text{NH}_4\text{Cl} = +14.78 \text{ kJ mol}^{-1}$
- $\Delta H_{\text{hyd}}^{\ominus} \text{Cl}^{-} = -359 \text{ kJ mol}^{-1}$

Answer:

Drawn as a Hess's Law cycle:

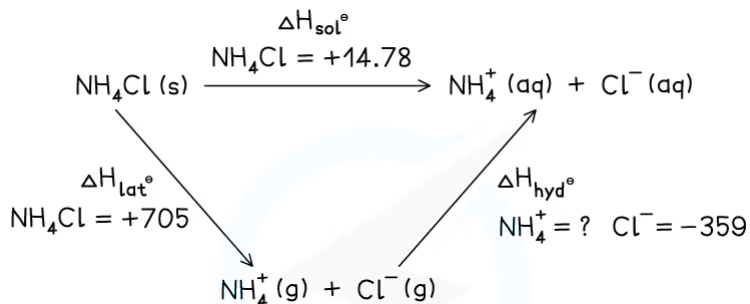

$$\Delta H_{\text{sol}}^{\circ} = \Delta H_{\text{lat}}^{\circ} + \Delta H_{\text{hyd}}^{\circ}$$

$$\Delta H_{\text{sol}}^{\circ} = \Delta H_{\text{lat}}^{\circ} + \Delta H_{\text{hyd}}^{\circ} \text{NH}_4^+ + \Delta H_{\text{hyd}}^{\circ} \text{Cl}^-$$

$$\Delta H_{\text{hyd}}^{\circ} \text{NH}_4^+ = \Delta H_{\text{sol}}^{\circ} - \Delta H_{\text{lat}}^{\circ} - \Delta H_{\text{hyd}}^{\circ} \text{Cl}^-$$

$$\begin{aligned}
 \Delta H_{\text{hyd}}^{\circ} \text{NH}_4^+ &= 14.78 - 705 - (-359) \\
 &= -331.22 \text{ k J mol}^{-1}
 \end{aligned}$$

Copyright © Save My Exams. All Rights Reserved

YOUR NOTES



Exam Tip

Exam problems in this topic often show diagrams with missing labels which you have to complete and find unknown values. The key to success in energy cycle calculations is not to panic, but have a careful step-by-step approach, show your workings and use brackets to separate mathematical operations from the enthalpy changes.

Size & Charge of Ions & Hydration Enthalpy

YOUR NOTES



- Hydration enthalpies are always **negative** values (exothermic)
- When an ionic solid dissolves in water, positive and negative ions are formed
- Water is a **polar** molecule with a δ^- oxygen (O) atom and δ^+ hydrogen (H) atoms which will form **ion-dipole attractions** with the ions present in the solution
- The oxygen atom in water will be attracted to the positive ions and the hydrogen atoms will be attracted to the negative ions

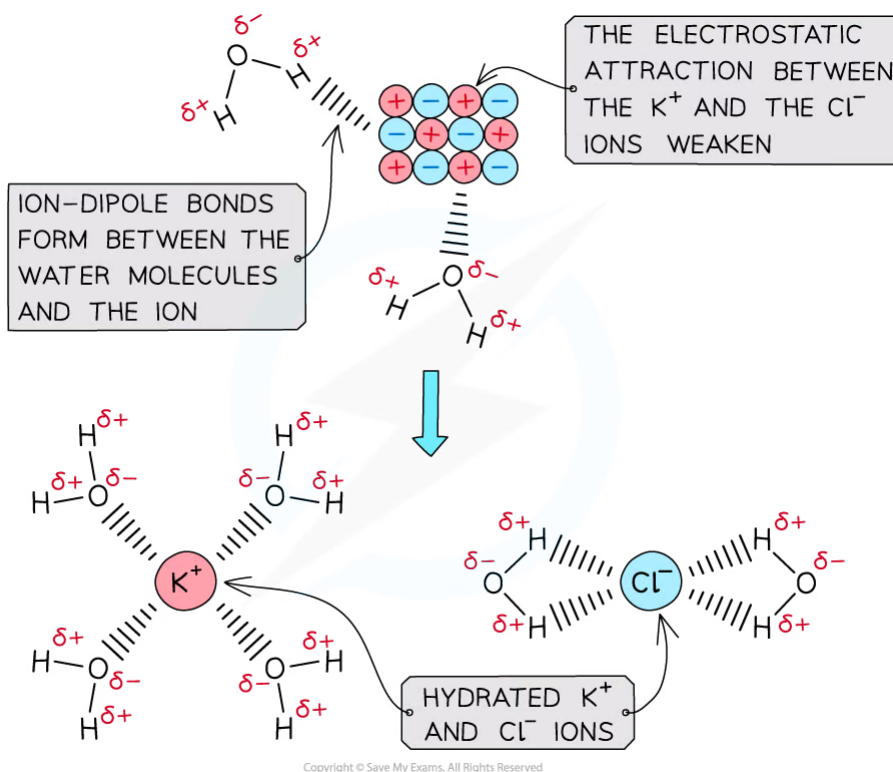

The polar water molecules will form ion-dipole bonds with the ions in solution causing the ions to become hydrated

- The size of the hydration enthalpy is governed by the amount of attraction between the ions and the water molecules
- The smaller the ion, the stronger the attraction between the ions and the water molecules
 - As you go down a group, the ionic radius increases so attraction decreases and the hydration enthalpy will become less exothermic
 - Overall, a smaller ion gives a more exothermic hydration enthalpy
- The more highly charged the ion; the stronger the attraction
 - The hydration enthalpies of 2+ ions in group 2 are much more exothermic than those of 1+ ions in group 1 as the attraction between the 2+ ions and the water molecules is stronger
 - Overall, a greater charge on the ion gives a more exothermic hydration enthalpy

Hydration enthalpies of group 1 and group 2 ions

Ion	$\Delta H_{\text{hyd}}^{\ominus}$ (kJ mol ⁻¹)	Ion	$\Delta H_{\text{hyd}}^{\ominus}$ (kJ mol ⁻¹)
Li ⁺	-538	Be ²⁺	-2524
Na ⁺	-424	Mg ²⁺	-1963
K ⁺	-340	Ca ²⁺	-1616
Rb ⁺	-315	Sr ²⁺	-1483
Cs ⁺	-291	Ba ²⁺	-1346

Copyright © Save My Exams. All Rights Reserved

YOUR NOTES



15.1.5 Energy Changes in Aqueous Solutions

YOUR NOTES



Measuring Energy Changes in the Lab

Enthalpies of Solution

- Calorimetry can be used to find the energy change in chemical reactions.
- This is much easier to carry out in aqueous solutions
- We can take different ionic compounds in the solid phase and dissolve them in water to determine lattice enthalpy
- We must know:
 - The mass of water used
 - The mass of solid used, so recording the mass of the weighing vessel should be taken before and after
- The temperature of the water should be recorded for a minimum period of 2 minutes before the solid is added
- Once the solid is added then the temperature can be recorded every 30 seconds for 10 minutes
 - If the reaction is exothermic, the temperature will increase
 - If the reaction is endothermic, the temperature will decrease
- The highest or lowest temperature recorded will be used to measure the difference in temperature
 - For example, if the initial temperature of the water is 22.4 °C and the lowest temperature recorded was 12.6 °C the temperature change would be 9.8 °C

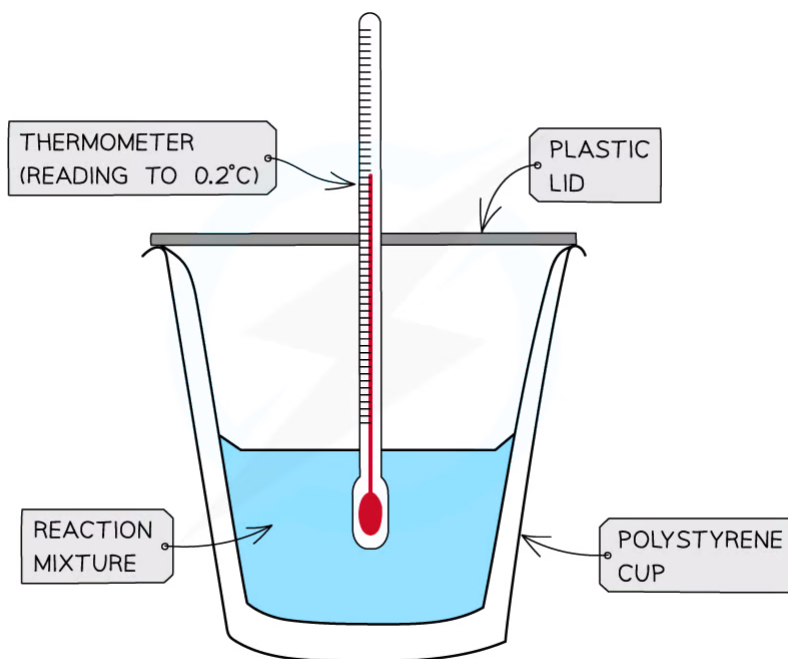

Copyright © Save My Exams. All Rights Reserved

- The energy needed to increase the temperature of 1 g of a substance by 1 °C is called the **specific heat capacity** (c) of the liquid
- The specific heat capacity of water is given in the data booklet as $4.18 \text{ J g}^{-1} \text{ K}^{-1}$

- The energy transferred as heat can be calculated by:

$$Q = m \times c \times \Delta T$$

Q = ENERGY CHANGE (J)

m = MASS OF SOLUTION (g)

c = SPECIFIC HEAT CAPACITY OF WATER

ΔT = TEMPERATURE CHANGE (EITHER °C OR K)

Copyright © Save My Exams. All Rights Reserved

Equation for calculating energy transferred in a calorimeter

- Once we know Q from the above equation, we can calculate the enthalpy change for the reaction
- Enthalpy of solution can be calculated by working out the energy change per mole of compound
- Remember, in the equation temperature change is required, i.e. the difference between the first reading and the highest / lowest reading
 - Therefore, the units for temperature do not matter as the change will still be the same in °C or K

Experiment 1: Addition of Ammonium Chloride and Sodium Iodide

	NH ₄ Cl	NaI
Temperature Change / °C	-13.8	-2.0
Heat Change / J	-5768	-836
Mass of Solid / g	20.05	19.94
Molar Mass / g mol ⁻¹	53.50	149.89
Amount of Solid / mol	0.3832	0.133
Enthalpy of Solution / kJ mol ⁻¹	+15.05	+6.28

Copyright © Save My Exams. All Rights Reserved

Sample data for the reaction of ammonium chloride, NH₄Cl, and sodium iodide, NaI, with water

To calculate an experimental value for enthalpy change of the reaction, ΔH , we can follow the same basic steps:

- Step 1: Compile the relevant important information:
 - Mass of water used in experiment = 100 g
 - Temperature change = 13.8 °C (endothermic reaction)
 - Mass of NH₄Cl = 20.05 g
 - Molar mass of NH₄Cl = 53.50 g mol⁻¹

YOUR NOTES





- Step 2: Calculate the energy change for the reaction:
 - $Q = mc\Delta T$
 - $Q = 100 \times 4.18 \times 13.8$
 - $Q = 5768 \text{ J}$
- Step 3: Calculate the number of moles of NH_4Cl
 - Moles = mass / molar mass
 - Moles of $\text{NH}_4\text{Cl} = 20.05 / 53.50$
 - Moles of $\text{NH}_4\text{Cl} = 0.3747 \text{ moles}$
- Step 4: Calculate the energy change per mole of compound:
 - $\Delta H = Q / \text{moles}$
 - $\Delta H = 5768 / 0.3747$
 - $\Delta H = 15390.9226 \text{ J mol}^{-1}$
- Therefore, in kJ mol^{-1} , the enthalpy change, ΔH , is **+15.39 kJ mol^{-1}**
- The data book value for the enthalpy of solution, $\Delta H_{\text{sol}}^\ominus$ of NH_4Cl is **+14.78 kJ mol^{-1}**
- The same calculations can be done for sodium iodide

Errors in this method

- Errors in the method will lead to a difference in the data book value and the experimental value
- For this method, some of these errors are:
 - Energy transfer to the surroundings (usually loss)
 - This is the largest and most obvious error
 - Approximation in specific heat capacity of water
 - This method assumes all solutions have the heat capacity of water
 - Neglecting the specific heat capacity of the calorimeter
 - The method ignores that the apparatus will absorb energy
 - An incomplete or slow reaction
 - Density of the solution is taken to be the same as water
- A data logger could be used in this method to record the temperature for this method which would considerably reduce the source of uncertainty
- Some solids also will absorb moisture from the atmosphere
 - This partly hydrates the solid and also effects the molar mass of the compound
- Data book values will refer to 'infinite dilution' whereas the solutions produced in this method are quite concentrated

Experiment 2: Addition of Zinc Powder to Copper(II) Sulfate

- The same calorimetry method can be used to record the temperature changes and therefore the ΔH for the reaction
- A known mass of zinc, Zn, is added to 50 cm^3 of 1.00 mol dm^{-3} copper(II) sulfate solution, $\text{CuSO}_4(\text{aq})$, and the temperature is recorded every 30 seconds for at least 10 minutes
- A graph can be drawn from the data which shows a maximum recorded temperature of $\Delta T = 35.2^\circ\text{C}$

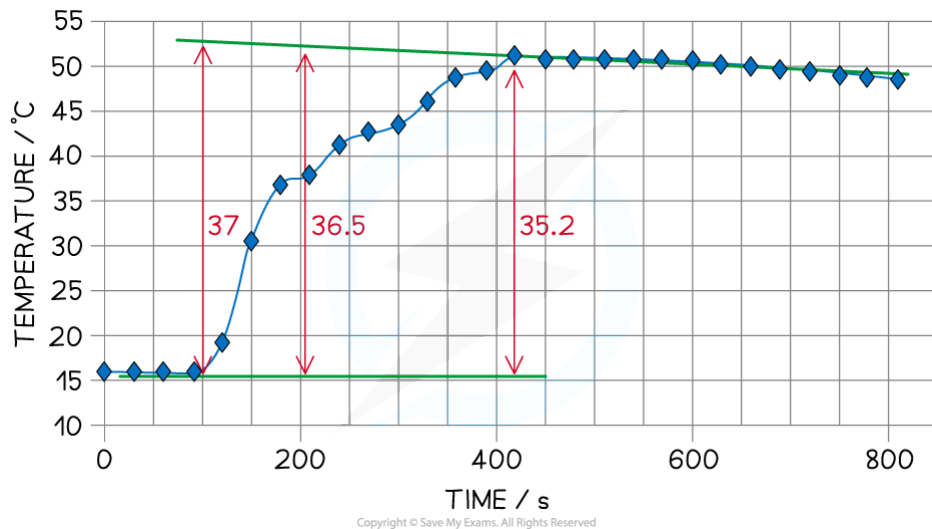

Temperature change for the reaction of zinc with copper(II) sulfate

- However, we need to extrapolate the graph to when the zinc was added which gives ΔT as roughly 37°C
- Important information
 - Volume of $1.00\text{ mol dm}^{-3}\text{ CuSO}_4$ used in experiment = 50 cm^3
 - Temperature change = 37°C (exothermic reaction)
 - Mass of weighing bottle and Zn = 6.087 g
 - Mass of weighing bottle after emptying = 1.064 g
 - Molar mass of Zn = 65.38 g mol^{-1}
- For this experiment, it is slightly different as there must be a limiting reagent
- In order to identify this, we must calculate the number of moles of Zn and CuSO_4
 - Moles = mass / molar mass
 - Moles of Zn = $5.023 / 65.38$
 - Moles of Zn = **0.0768 moles**
 - Moles = concentration x volume (dm^3)
 - Moles of CuSO_4 = 1.00×0.050
 - Moles of CuSO_4 = **0.050 moles**
- Therefore, the CuSO_4 is the limiting reagent and should be used to calculate ΔH for the reaction
- Calculate the energy change, Q:
 - $Q = mc\Delta T$
 - $Q = 50 \times 4.18 \times 37$
 - $Q = \mathbf{7733\text{ J}}$
- Calculate ΔH :
 - $\Delta H = -Q / \text{moles of CuSO}_4$, using $-Q$ as it is an exothermic reaction
 - $\Delta H = -7733 / 0.050$
 - $\Delta H = -154660\text{ J mol}^{-1}$
 - $\Delta H = \mathbf{-154.6\text{ kJ mol}^{-1}}$

YOUR NOTES





Worked Example

Calculate the energy change per mole for a reaction where 25 cm³ of 2.00 mol dm⁻³ hydrochloric acid was neutralised by 25 cm³ of 2.00 mol dm⁻³ sodium hydroxide. The temperature increased by 13.5 °C.

YOUR NOTES

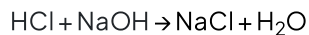
**Answer:****Step 1:** Write an equation for the reaction occurring**Step 2:** Calculate the energy change for the amount of reactants in the reaction vessel (remember that the mass equals the mass of acid and alkali)

- $Q = mc\Delta T$
 - $Q = 50 \times 4.18 \times 13.5$
 - $Q = 2821.5 \text{ J}$

Step 3: Calculate the number of moles of HCl (remember that neutralisation has occurred)

- Moles of HCl = concentration \times volume (dm³)
 - moles of HCl = 2×0.025
 - moles of HCl = 0.05 moles

Step 4: Calculate ΔH , using $-Q$ as it is an exothermic reaction

- $\Delta H = -Q / \text{moles of HCl}$
 - $\Delta H = -2821.5 / 0.05$
 - $\Delta H = -56430 \text{ J mol}^{-1}$
 - $\Delta H = -56.4 \text{ kJ mol}^{-1}$

15.2 Entropy & Spontaneity

15.2.1 Entropy

Entropy

Entropy

- You may have wondered why it is that endothermic reactions occur at all, after all, what can be the driving force behind endothermic reactions if the products end up in a less stable, higher energy state?
- Although the majority of chemical reactions we experience everyday are exothermic, ΔH^\ddagger alone is not enough to explain why endothermic reactions occur

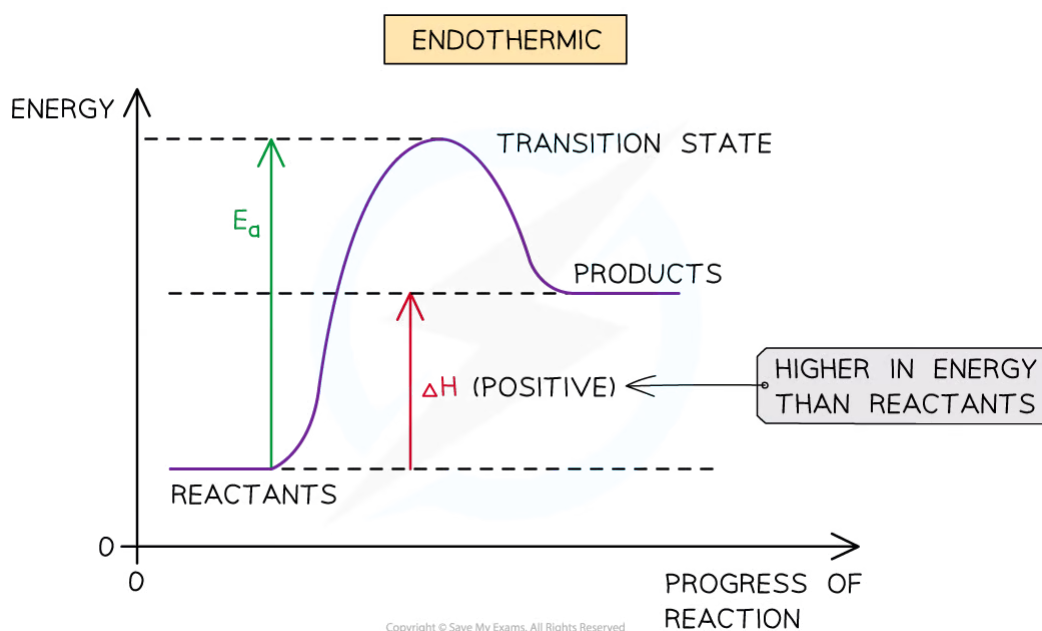

The driving force behind chemical reactions cannot be explained by enthalpy changes alone as it does not sense for chemical to end up in a less stable higher energy state in endothermic reactions

- The answer is entropy

YOUR NOTES



Predicting Entropy Changes

YOUR NOTES



Chaos in the universe

- The **entropy (S)** of a given system is the number of possible arrangements of the particles and their energy in a given system
 - In other words, it is a measure of how **disordered** or **chaotic** a system is
- When a system becomes more disordered, its entropy will increase
- An increase in entropy means that the system becomes **energetically more stable**
- For example, during the thermal decomposition of calcium carbonate (CaCO_3) the entropy of the system increases:



- In this decomposition reaction, a gas molecule (CO_2) is formed
- The CO_2 gas molecule is more disordered than the solid reactant (CaCO_3), as it is constantly moving around
- As a result, the system has become more disordered and there is an increase in entropy
- Another typical example of a system that becomes more disordered is when a solid melts
 - For example, melting ice to form liquid water:

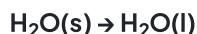

- The water molecules in ice are in fixed positions and can only vibrate about those positions
- In the liquid state, the particles are still quite close together but are arranged more randomly, in that they can move around each other
- Water molecules in the liquid state are therefore more disordered
- Thus, for a given substance, the entropy increases when its solid form melts into a liquid
- In both examples, the system with the **higher entropy** will be **energetically favourable** (as the energy of the system is more spread out when it is in a disordered state)

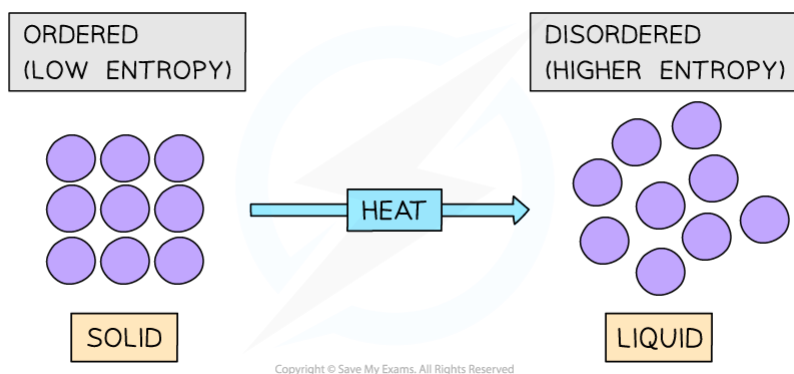

Melting a solid will cause the particles to become more disordered resulting in a higher entropy state

15.2.2 Calculating Entropy Change

Calculating Standard Entropy Change

- The standard molar enthalpy values, S^{\ominus} , relate to standard conditions of temperature and pressure
- The entropy change, ΔS^{\ominus} , can be calculated from thermodynamic data using the following equation:

$$\Delta S^{\ominus}_{298}(\text{reaction}) = \Sigma S^{\ominus}_{298}(\text{products}) - \Sigma S^{\ominus}_{298}(\text{reactants})$$

- This equation is provided in the data booklet
- The units of $\Delta S_{\text{system}}^{\ominus}$ are in $\text{JK}^{-1}\text{mol}^{-1}$
- Entropy will change depending on the state of the matter
- Taking water as an example the values for S^{\ominus} will be different for the liquid and gaseous phases
 - $S^{\ominus}_{298}(\text{H}_2\text{O}(\text{l})) = 70.0 \text{ JK}^{-1}\text{mol}^{-1}$
 - $S^{\ominus}_{298}(\text{H}_2\text{O}(\text{g})) = 188.8 \text{ JK}^{-1}\text{mol}^{-1}$
- When calculating ΔS^{\ominus} , the coefficients used to balance the equation must be applied when calculating the overall entropy change
- For example, when calculating the ΔS^{\ominus} for the reaction below we need to double the value for $S^{\ominus}(\text{NO}(\text{g}))$
 - $\text{N}_2\text{O}_4(\text{g}) \rightarrow 2\text{NO}_2(\text{g})$
 - $\Delta S^{\ominus}_{298}(\text{reaction}) = \Sigma S^{\ominus}_{298}(\text{products}) - \Sigma S^{\ominus}_{298}(\text{reactants})$
 - $\Delta S^{\ominus} = [(2 \times S^{\ominus}_{298}(\text{NO}_2))] - S^{\ominus}_{298}(\text{N}_2\text{O}_4)$



Worked Example

What is the entropy change when calcium carbonate decomposes?



- $S^{\ominus}_{298}(\text{CaCO}_3(\text{s})) = 92.9 \text{ JK}^{-1}\text{mol}^{-1}$
- $S^{\ominus}_{298}(\text{CaO}(\text{s})) = 39.7 \text{ JK}^{-1}\text{mol}^{-1}$
- $S^{\ominus}_{298}(\text{CO}_2(\text{g})) = 213.6 \text{ JK}^{-1}\text{mol}^{-1}$

Answer:

Step 1: Write out equation to calculate $\Delta S^{\ominus}_{298}(\text{reaction})$

$$\Delta S^{\ominus}_{298}(\text{reaction}) = \Sigma S^{\ominus}_{298}(\text{products}) - \Sigma S^{\ominus}_{298}(\text{reactants})$$

Step 2: Substitute in formulas and then values for S^{\ominus}

- $\Delta S^{\ominus}_{298}(\text{reaction}) = [S^{\ominus}_{298}(\text{CaO}) + S^{\ominus}_{298}(\text{CO}_2)] - S^{\ominus}_{298}(\text{CaCO}_3)$
- $\Delta S^{\ominus}(\text{reaction}) = (39.7 + 213.6) - 92.9$
- $\Delta S^{\ominus}(\text{reaction}) = +160.4 \text{ JK}^{-1}\text{mol}^{-1}$

YOUR NOTES





Worked Example

What is the entropy change when ammonia is formed **from** nitrogen and hydrogen?



- $S_{298}^{\ominus}(\text{N}_2(\text{g})) = 191.6 \text{ J K}^{-1} \text{ mol}^{-1}$
- $S_{298}^{\ominus}(\text{H}_2(\text{g})) = 131 \text{ J K}^{-1} \text{ mol}^{-1}$
- $S_{298}^{\ominus}(\text{NH}_3) = 192.3 \text{ J K}^{-1} \text{ mol}^{-1}$

Answer:

Step 1: Write out equation to calculate $\Delta S_{298}^{\ominus}(\text{reaction})$

$$\Delta S_{298}^{\ominus}(\text{reaction}) = \Sigma S_{298}^{\ominus}(\text{products}) - \Sigma S_{298}^{\ominus}(\text{reactants})$$

Step 2: Substitute in formulas and then values for S^{\ominus} taking into account the coefficients

- $\Delta S_{298}^{\ominus}(\text{reaction}) = [2 \times S_{298}^{\ominus}(\text{NH}_3)] - [S_{298}^{\ominus}(\text{N}_2) + (3 \times S_{298}^{\ominus}(\text{H}_2))]$
- $\Delta S_{298}^{\ominus}(\text{reaction}) = [2 \times 192.3] - [191.6 + (3 \times 131)]$
- $\Delta S_{298}^{\ominus}(\text{reaction}) = 384.6 - 584.6$
- $\Delta S_{298}^{\ominus}(\text{reaction}) = -200 \text{ J K}^{-1} \text{ mol}^{-1}$

YOUR NOTES



15.2.3 Gibbs Free Energy

YOUR NOTES



Gibbs Free Energy Change

Gibbs free energy

- The feasibility of a reaction is determined by two factors, the enthalpy change and the [popover id="F7rfknVfbfcSJVkN" label='entropy change']
- The two factors come together in a fundamental thermodynamic concept called the **Gibbs free energy (G)**
- The Gibbs equation is:

$$\Delta G^{\ominus} = \Delta H_{\text{reaction}}^{\ominus} - T\Delta S_{\text{system}}^{\ominus}$$

- The units of ΔG^{\ominus} are in kJ mol^{-1}
- The units of $\Delta H_{\text{reaction}}^{\ominus}$ are in kJ mol^{-1}
- The units of T are in K
- The units of $\Delta S_{\text{system}}^{\ominus}$ are in $\text{J K}^{-1} \text{mol}^{-1}$ (and must therefore be converted to $\text{kJ K}^{-1} \text{mol}^{-1}$ by dividing by 1000)

Calculating ΔG^{\ominus}

- There are two ways you can calculate the value of ΔG^{\ominus}
 - From the Gibbs equation, using enthalpy change, ΔH^{\ominus} , and entropy change, ΔS^{\ominus} , values
 - From ΔG^{\ominus} values of all the substances present

Calculating ΔG^{\ominus} from the Gibbs Equation



Worked Example

ΔG^{\ominus} from ΔH^{\ominus} and ΔS^{\ominus} values Calculate the free energy change for the following reaction:

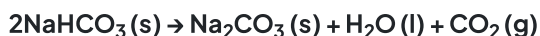

- $\Delta H^{\ominus} = +135 \text{ kJ mol}^{-1}$
- $\Delta S^{\ominus} = +344 \text{ J K}^{-1} \text{mol}^{-1}$

Answer:

Step 1: Convert the entropy value in kilojoules

$$\Delta S^{\ominus} = +344 \text{ J K}^{-1} \text{mol}^{-1} \div 1000 = +0.344 \text{ kJ K}^{-1} \text{mol}^{-1}$$

Step 2: Substitute the terms into the Gibbs Equation

$$\begin{aligned} \Delta G^{\ominus} &= \Delta H_{\text{reaction}}^{\ominus} - T\Delta S_{\text{system}}^{\ominus} \\ &= +135 - (298 \times 0.344) \\ &= +\mathbf{32.49 \text{ kJ mol}^{-1}} \end{aligned}$$

The temperature is 298 K since standard values are quoted in the question

Calculating ΔG^\ominus from ΔG^\ominus Formation

YOUR NOTES



Worked Example

ΔG^\ominus from other ΔG^\ominus values What is the standard free energy change, ΔG^\ominus , for the following reaction?

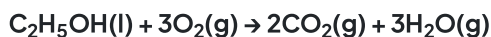

Substance	$\Delta G^\ominus \text{ kJ mol}^{-1}$
$\text{C}_2\text{H}_5\text{OH}(\text{l})$	-175
$\text{O}_2(\text{g})$	0
$\text{CO}_2(\text{g})$	-394
$\text{H}_2\text{O}(\text{g})$	-229

Copyright © Save My Exams. All Rights Reserved

Answer:

- This can be calculated in the same way as you complete enthalpy calculations
- $\Delta G^\ominus = \sum \Delta G_{\text{products}}^\ominus - \sum \Delta G_{\text{reactants}}^\ominus$
 - $\Delta G^\ominus = [(2 \times \text{CO}_2) + (3 \times \text{H}_2\text{O})] - [(\text{C}_2\text{H}_5\text{OH}) + (3 \times \text{O}_2)]$
 - $\Delta G^\ominus = [(2 \times -394) + (3 \times -229)] - [-175 + 0]$
 - $\Delta G^\ominus = -1300 \text{ kJ mol}^{-1}$
- This can also be done by drawing a Hess cycle - find the way that is best for you

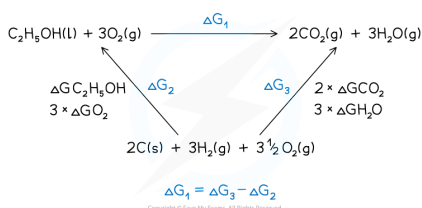

Exam Tip

The idea of free energy is what's 'leftover' to do useful work when you've carried out the reaction. The enthalpy change is the difference between the energy you put in to break the chemical bonds and the energy out when making new bonds. The entropy change is the 'cost' of carrying out the reaction, so free energy is what you are left with!

15.2.4 Spontaneous Reactions

YOUR NOTES



Spontaneous Reactions

- Gibbs free energy provides an effective way of focusing on a reaction system at constant temperature and pressure to determine its spontaneity
- For a reaction to be spontaneous, Gibbs free energy must be have a **negative** value ($\Delta G^\ddagger \leq 0$)
- We can use the Gibbs equation to calculate whether a reaction is **spontaneous** / feasible or not

$$\Delta G^\ddagger = \Delta H_{\text{reaction}}^\ddagger - T\Delta S_{\text{system}}^\ddagger$$

- When ΔG^\ddagger is **negative**, the reaction is **spontaneous / feasible** and likely to occur
- When ΔG^\ddagger is **positive**, the reaction is **not spontaneous / feasible** and unlikely to occur
- We can also look at the the values for enthalpy change, ΔH , and entropy change, ΔS
 - Depending on the value for ΔH and ΔS we can determine whether the reaction is spontaneous at a given temperature (T)

If $\Delta H...$	And if $\Delta S...$	Then ΔG is...	Spontaneous...	Because
Is negative < 0 exothermic	Is positive > 0 More disorder	Always negative < 0	Always	Forward reaction spontaneous at any T
Is positive > 0 endothermic	Is negative < 0 More order	Always positive > 0	Never	Reverse reaction spontaneous at any T
Is negative < 0 exothermic	Is negative < 0 More order	Negative at low T Positive at high T	Depending on T	Spontaneous only at low T $T\Delta S < H$
Is positive > 0 endothermic	Is positive > 0 More disorder	Negative at high T Positive at low T	Depending on T	Spontaneous only at high T $T\Delta S > H$

Factors affecting ΔG and the spontaneity / feasibility of a reaction



Worked Example

Determining if a reaction is feasible / spontaneous

- Calculate the Gibbs free energy change for the following reaction at 298 K
- Determine whether the reaction is feasible.



- $S^\ddagger[\text{Ca(s)}] = 41.00 \text{ J K}^{-1} \text{ mol}^{-1}$
- $S^\ddagger[\text{O}_2\text{(g)}] = 205.0 \text{ J K}^{-1} \text{ mol}^{-1}$
- $S^\ddagger[\text{CaO(s)}] = 40.00 \text{ J K}^{-1} \text{ mol}^{-1}$

Answers:

Answer 1:

Step 1: Calculate $\Delta S_{\text{system}}^\ddagger$



$$\begin{aligned} \Delta S_{\text{system}}^{\ominus} &= \Sigma \Delta S_{\text{products}}^{\ominus} - \Sigma \Delta S_{\text{reactants}}^{\ominus} \\ \Delta S_{\text{system}}^{\ominus} &= (2 \times \Delta S^{\ominus}[\text{CaO(s)}]) - (2 \times \Delta S^{\ominus}[\text{Ca(s)}] + \Delta S^{\ominus}[\text{O}_2(\text{g})]) \\ &= (2 \times 40.00) - (2 \times 41.00 + 205.0) \\ &= -207.0 \text{ J K}^{-1} \text{ mol}^{-1} \end{aligned}$$

Step 2: Convert ΔS^{\ominus} to $\text{kJ K}^{-1} \text{ mol}^{-1}$

$$\Delta S_{\text{system}}^{\ominus} = -207.0 \text{ J K}^{-1} \text{ mol}^{-1} \div 1000 = -0.207 \text{ kJ mol}^{-1}$$

Step 3: Calculate ΔG^{\ominus}

$$\begin{aligned} \Delta G^{\ominus} &= \Delta H_{\text{reaction}}^{\ominus} - T \Delta S_{\text{system}}^{\ominus} \\ \Delta G^{\ominus} &= -635.5 - (298 \times -0.207) \\ &= -573.8 \text{ kJ mol}^{-1} \end{aligned}$$

Answer 2:

- Since ΔG^{\ominus} is **negative**, the reaction is **feasible**

Factors affecting ΔG and the spontaneity / feasibility of a reaction

- We can also look at the the values for ΔH and ΔS to determine whether the reaction is spontaneous / feasible at a given temperature (T)
- The Gibbs equation will be used to explain what will affect the spontaneity / feasibility of a reaction for exothermic and endothermic reactions

$$\Delta G = \underbrace{\Delta H_{\text{reaction}}}_{\text{FIRST TERM}} - \underbrace{T \Delta S_{\text{system}}}_{\text{SECOND TERM}}$$

Copyright © Save My Exams. All Rights Reserved

Exothermic reactions

- In exothermic reactions, $\Delta H_{\text{reaction}}^{\ominus}$ is **negative**
- If the $\Delta S_{\text{system}}^{\ominus}$ is **positive**:
 - Both the first and second term will be **negative**
 - Resulting in a **negative** ΔG^{\ominus} so the reaction is **feasible**
 - Therefore, regardless of the temperature, an exothermic reaction with a positive $\Delta S_{\text{system}}^{\ominus}$ will **always be feasible**
- If the $\Delta S_{\text{system}}^{\ominus}$ is **negative**:
 - The first term is **negative** and the second term is **positive**
 - At very high temperatures, the $-T \Delta S_{\text{system}}^{\ominus}$ will be very **large** and **positive** and will overcome $\Delta H_{\text{reaction}}^{\ominus}$
 - Therefore, at high temperatures ΔG^{\ominus} is **positive** and the reaction is **not feasible**
- Since the relative size of an entropy change is much smaller than an enthalpy change, it is unlikely that $T \Delta S > \Delta H$ as temperature increases
- These reactions are therefore usually spontaneous at normal conditions

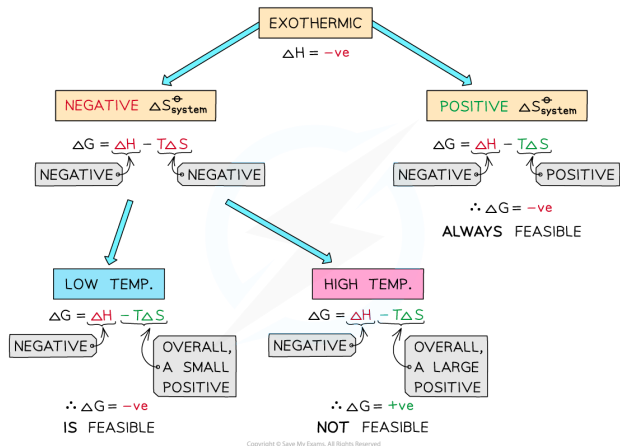

The diagram shows under which conditions exothermic reactions are feasible

Endothermic reactions

- In endothermic reactions, $\Delta H_{\text{reaction}}$ is **positive**
- If the ΔS_{system} is **negative**:
 - Both the first and second term will be **positive**
 - Resulting in a **positive** ΔG so the reaction is **not feasible**
 - Therefore, regardless of the temperature, endothermic with a negative ΔS_{system} will **never be feasible**
- If the ΔS_{system} is **positive**:
 - The first term is **positive** and the second term is **negative**
 - At low temperatures, the $-T\Delta S_{\text{system}}$ will be **small** and **negative** and will not overcome the larger $\Delta H_{\text{reaction}}$
 - Therefore, at low temperatures ΔG is **positive** and the reaction is not feasible
 - The reaction is **more feasible** at **high temperatures** as the second term will become negative enough to overcome the $\Delta H_{\text{reaction}}$ resulting in a negative ΔG
- This tells us that for certain reactions which are not feasible at room temperature, they can become feasible at higher temperatures
 - An example of this is found in metal extractions, such as the extraction of iron in the blast furnace, which will be unsuccessful at low temperatures but can occur at higher temperatures (~1500 °C in the case of iron)

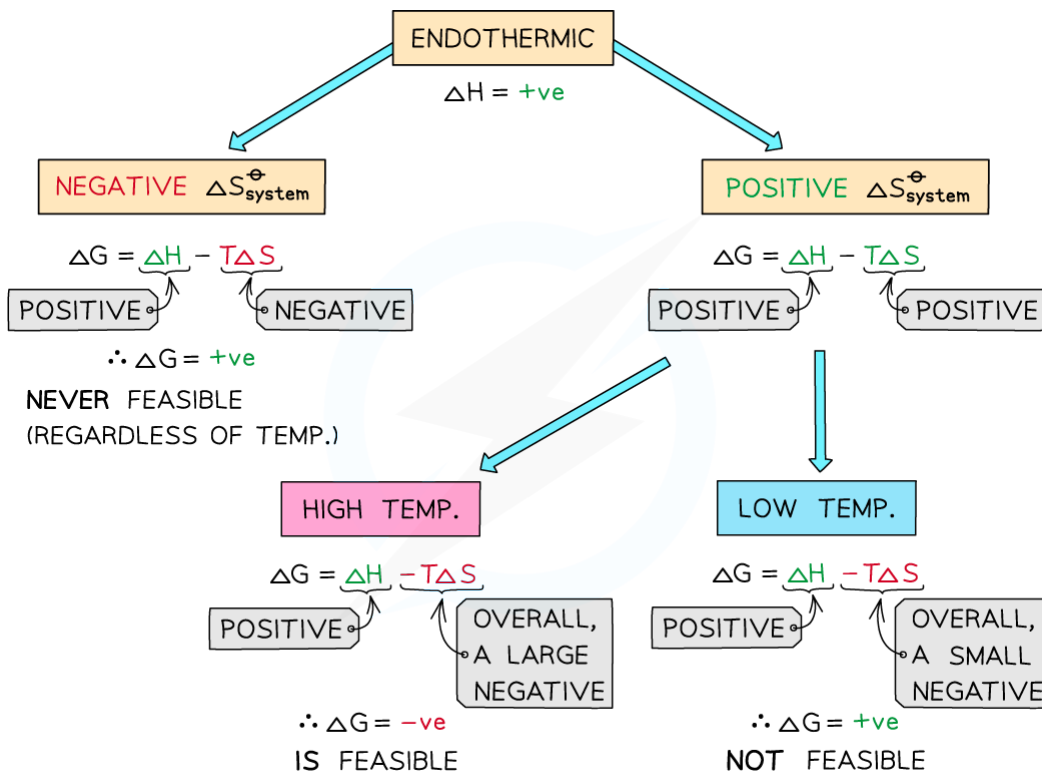

Copyright © Save My Exams. All Rights Reserved

The diagram shows under which conditions endothermic reactions are feasible

Summary of factors affecting Gibbs free energy

If $\Delta H...$	And if $\Delta S...$	Then ΔG is...	Spontaneous...	Because
Is negative < 0 exothermic	Is positive > 0 More disorder	Always negative < 0	Always	Forward reaction spontaneous at any T
Is positive > 0 endothermic	Is negative < 0 More order	Always positive > 0	Never	Reverse reaction spontaneous at any T
Is negative < 0 exothermic	Is negative < 0 More order	Negative at low T Positive at high T	Depending on T	Spontaneous only at low T $T\Delta S < H$
Is positive > 0 endothermic	Is positive > 0 More disorder	Negative at high T Positive at low T	Depending on T	Spontaneous only at high T $T\Delta S > H$

Copyright © Save My Exams. All Rights Reserved

15.2.5 Free Energy & Equilibrium

YOUR NOTES



Free Energy & Equilibrium

- When $\Delta G < 0$ for a reaction at constant temperature and pressure, the reaction is spontaneous
- When a reversible reaction reaches equilibrium, the Gibbs free energy is changing as the ratio of reactants to products changes
- For non-reversible reactions:
 - As the amount of products increases, the reaction moves towards completion
 - This leads to a decrease in Gibbs free energy
- For reversible reactions:
 - As the amount of products increases, the reaction moves towards equilibrium
 - This causes a decrease in Gibbs free energy
- At the point of equilibrium, Gibbs free energy is at its lowest as shown on the graph:

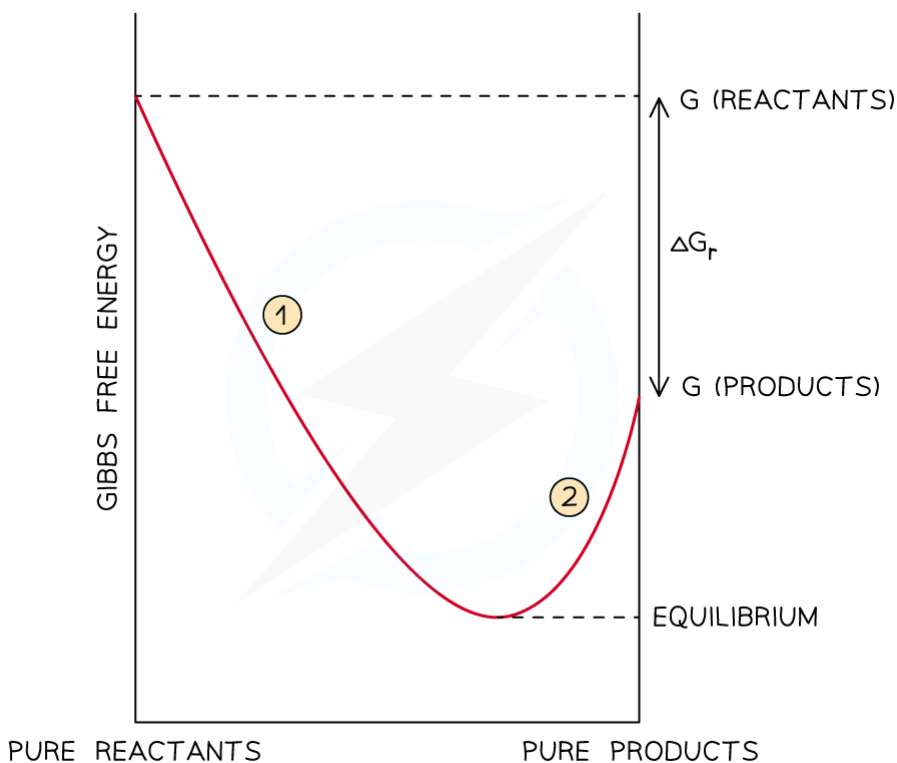

Gibbs free energy changes as the reaction proceeds

- In section 1 of the graph, the forward reaction is favoured and the reaction proceeds towards a minimum value
- Having reached a point of equilibrium, the Gibbs free energy increases
 - This is when the reaction becomes non-spontaneous (section 2)
- The reverse reaction now becomes spontaneous and the Gibbs free energy again reaches the minimum value, so heads back towards equilibrium

- The reaction will be spontaneous in the direction that results in a decrease in free energy (becomes more negative)
- When the equilibrium constant, K , is determined for a given reaction, its value indicates whether the products or reactants are favoured at equilibrium
- ΔG is an indication of whether the forward or backward reaction is favoured

YOUR NOTES

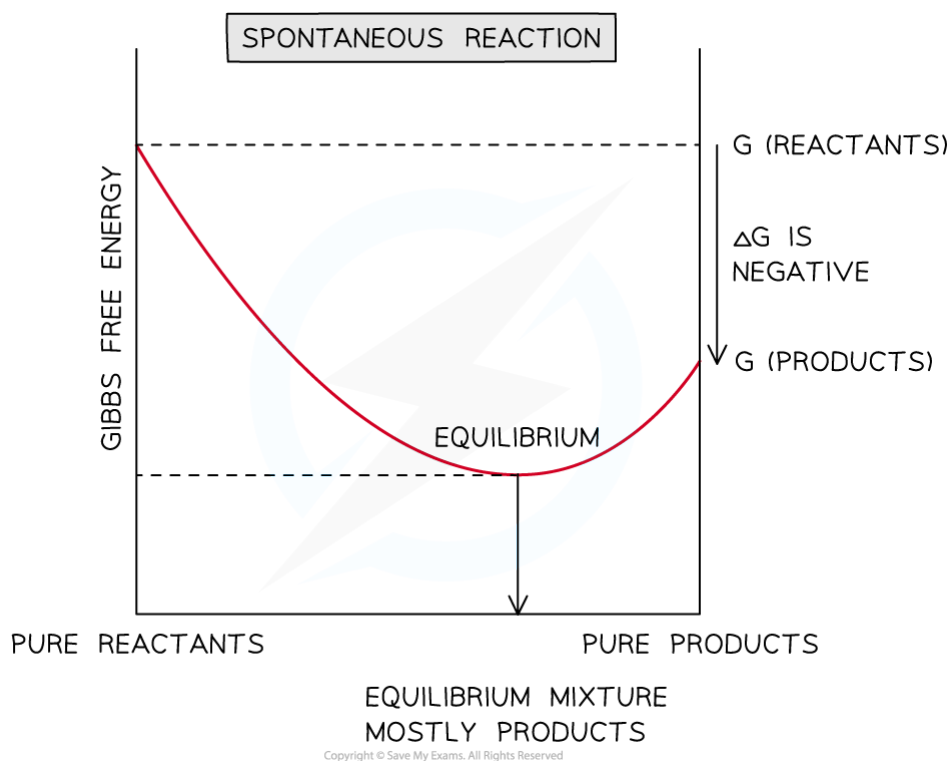

Graph for a spontaneous reaction

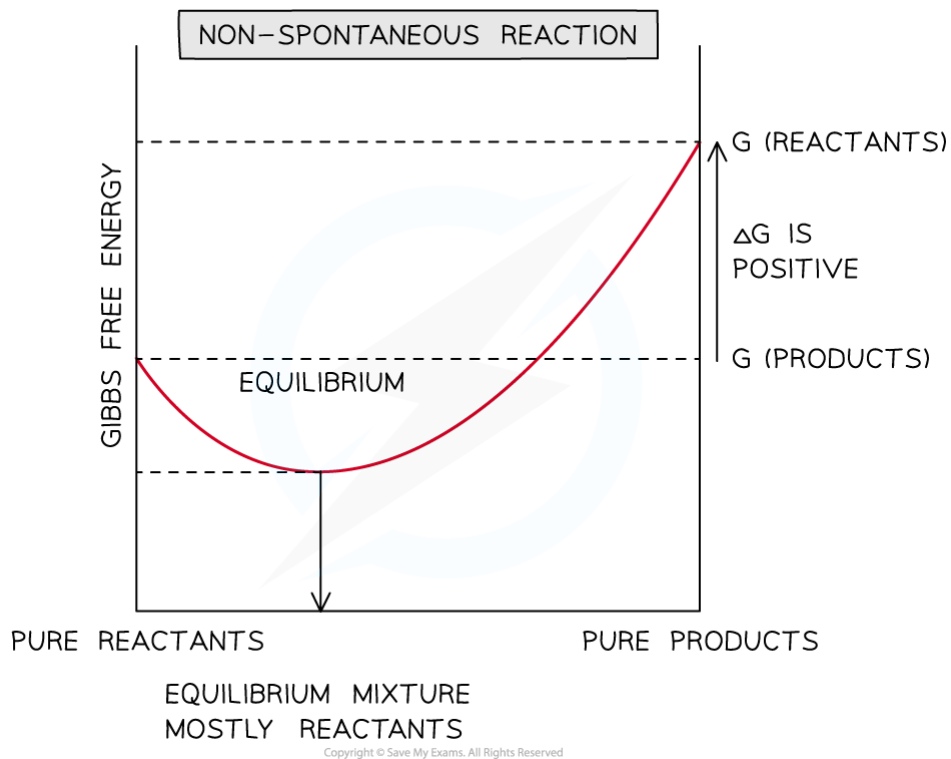

Graph for a non-spontaneous reaction

- The quantitative relationship between standard Gibbs free energy change, temperature and the equilibrium constant is represented by:

$$\Delta G^\ominus = -RT \ln K$$



Head to [savemyexams.co.uk](https://www.savemyexams.co.uk) for more awesome resources