

# IB Chemistry DP

## 13. HL The Periodic Table- Transition Metals

### CONTENTS

#### 13.1 Transition Metals

##### 13.1.1 Transition Elements

##### 13.1.2 Variable Oxidation States

##### 13.1.3 Complex Ions

##### 13.1.4 Catalytic & Magnetic Properties

##### 13.1.5 Colour in Transition Metals

##### 13.1.6 Factors Affecting Colour

YOUR NOTES





## 13.1 Transition Metals

### 13.1.1 Transition Elements

#### Transition Elements

- Transition metals are elements with an incomplete d-subshell or that can form at least one stable cation with an incomplete d-subshell
- This definition distinguishes them from d-block elements, because scandium and zinc do not fit the definition
  - Scandium only forms the ion  $\text{Sc}^{3+}$ , configuration  $[\text{Ar}] 3d^0$
  - Zinc only forms the ion  $\text{Zn}^{2+}$ , configuration  $[\text{Ar}] 3d^{10}$
- The elements of the first transition series are therefore titanium to copper

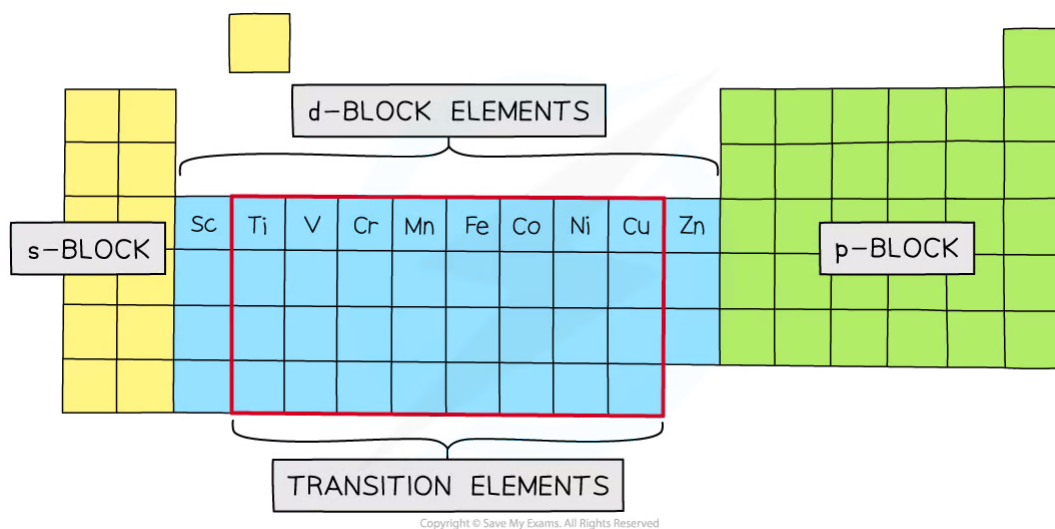

#### *The transition elements and the d-block elements*

#### Electron Configuration

- The full electronic configuration of the first d-series transition metals is shown in the table below
- Following the [Aufbau Principle] electrons occupy the lowest energy subshells first
- The 4s overlaps with the 3d subshell so the 4s is filled first
- Remember that you can abbreviate the first five subshells, 1s-3p, as  $[\text{Ar}]$  representing the configuration of argon (known as the argon core)

#### Table showing the electronic configuration of the first d-series transition elements



Element	Electronic Configuration
Ti	$1s^2 2s^2 2p^6 3s^2 3p^6 3d^2 4s^2$
V	$1s^2 2s^2 2p^6 3s^2 3p^6 3d^3 4s^2$
Cr	$1s^2 2s^2 2p^6 3s^2 3p^6 3d^5 4s^1$
Mn	$1s^2 2s^2 2p^6 3s^2 3p^6 3d^5 4s^2$
Fe	$1s^2 2s^2 2p^6 3s^2 3p^6 3d^6 4s^2$
Co	$1s^2 2s^2 2p^6 3s^2 3p^6 3d^7 4s^2$
Ni	$1s^2 2s^2 2p^6 3s^2 3p^6 3d^8 4s^2$
Cu	$1s^2 2s^2 2p^6 3s^2 3p^6 3d^{10} 4s^1$

Copyright © Save My Exams. All Rights Reserved

- From your previous studies in chemistry, you should recall there are two exceptions to the **Aufbau Principle** in the first row of d-block, chromium and copper
- In both cases an electron is promoted from the 4s to the 3d to achieve a half full and full d-subshell, respectively
- Chromium and copper have the following electron configurations, which are different to what you may expect:
  - Cr is  $[Ar] 3d^5 4s^1$  **not**  $[Ar] 3d^4 4s^2$
  - Cu is  $[Ar] 3d^{10} 4s^1$  **not**  $[Ar] 3d^9 4s^2$
- This is because the  $[Ar] 3d^5 4s^1$  and  $[Ar] 3d^{10} 4s^1$  configurations are **energetically more stable** and are preferred configurations
- When forming cations, remove the 4s electrons first



### Worked Example

**Writing electronic configuration of transition element ions** State the full electronic configuration of the manganese(III) ion

#### Answer

**Step 1:** Write out the electron configuration of the atom first:

Mn atomic number = 25

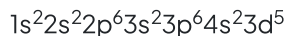

$$2 + 2 + 6 + 2 + 6 + 2 + 5 = 25 \text{ electrons}$$

**Step 2:** Subtract the appropriate number of electrons starting from the 4s subshell

$$\text{Mn(III)} = 22 \text{ electrons}$$

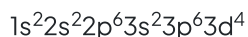

## General properties

- Although the **transition elements** are metals, they have some properties unlike those of other metals on the periodic table, such as:
  - Variable **oxidation states**
  - Form **complex ions**
  - Form **coloured compounds**
  - Behave as **catalysts**
  - Have **magnetic properties**

## Variable Oxidation States

- Like other metals on the periodic table, the transition elements will lose electrons to form positively charged ions
- However, unlike other metals, transition elements can form more than one positive ion
  - They are said to have **variable oxidation states**
- Because of this, Roman numerals are used to indicate the oxidation state on the metal ion
  - For example, the metal sodium (Na) will only form  $\text{Na}^+$  ions (no Roman numerals are needed, as the ion formed by Na will always have an oxidation state of +1)
  - The transition metal iron (Fe) can form  $\text{Fe}^{2+}$  (Fe(II)) **and**  $\text{Fe}^{3+}$  (Fe(III)) ions

## Forming Complex Ions

- Another property of transition elements caused by their ability to form variable oxidation states, is their ability to form **complex ions**
- A complex ion is a molecule or ion, consisting of a central metal atom or ion, with a number of molecules or ions surrounding it
- A molecule or ion surrounding the central metal atom or ion is called a ligand
- Due to the different oxidation states of the central metal ions, a different number and wide variety of ligands can form bonds with the transition element
  - For example, the chromium(III) ion can form  $[\text{Cr}(\text{NH}_3)_6]^{3+}$ ,  $[\text{Cr}(\text{OH})_6]^{3-}$  and  $[\text{Cr}(\text{H}_2\text{O})_6]^{3+}$  complex ions

## Forming coloured compounds

- Another characteristic property of transition elements is that their compounds are often **coloured**
  - For example, the colour of the  $[\text{Cr}(\text{OH})_6]^{3-}$  complex (where oxidation state of Cr is +3) is **dark green**
  - Whereas the colour of the  $[\text{Cr}(\text{NH}_3)_6]^{3+}$  complex (oxidation state of Cr is still +3) is **purple**

## Transition elements as catalysts

YOUR NOTES



- Since transition elements can have variable oxidation states, they make excellent **catalysts**
- During catalysis, the transition element can change to various oxidation states by gaining electrons from or donating electrons to reagents within the reaction
- Substances can also be adsorbed onto their surface and activated in the process

## Magnetic Properties

- Materials are classified as **diamagnetic**, **paramagnetic** or **ferromagnetic** according to their behaviour when placed in an external magnetic field
- Transition metals exhibit these properties depending on their electronic configurations

YOUR NOTES



## 13.1.2 Variable Oxidation States

YOUR NOTES



**Variable Oxidation States**

- When transition elements form ions they lose electrons from the **4s** subshell first
- This is because when the orbitals are occupied, the repulsion between electrons pushes the **4s** into a higher energy state so that it now becomes slightly higher in energy than the **3d** subshell
  - The **4s** is now the outer shell and loses electrons first
- The loss of the **4s** electrons means that **+2** is a common **oxidation state** in transition metals
- The reason why the transition metals have variable oxidation states all comes down to energy

**Table showing the the common oxidation states of transition elements**

Transition element	Common oxidation states
Ti	+2, +3, +4
V	+2, +3, +4, +5
Cr	+2, +3, +6
Mn	+2, +4, +6, +7
Fe	+2, +3
Co	+2, +3
Ni	+2, +3, +4
Cu	+1, +2

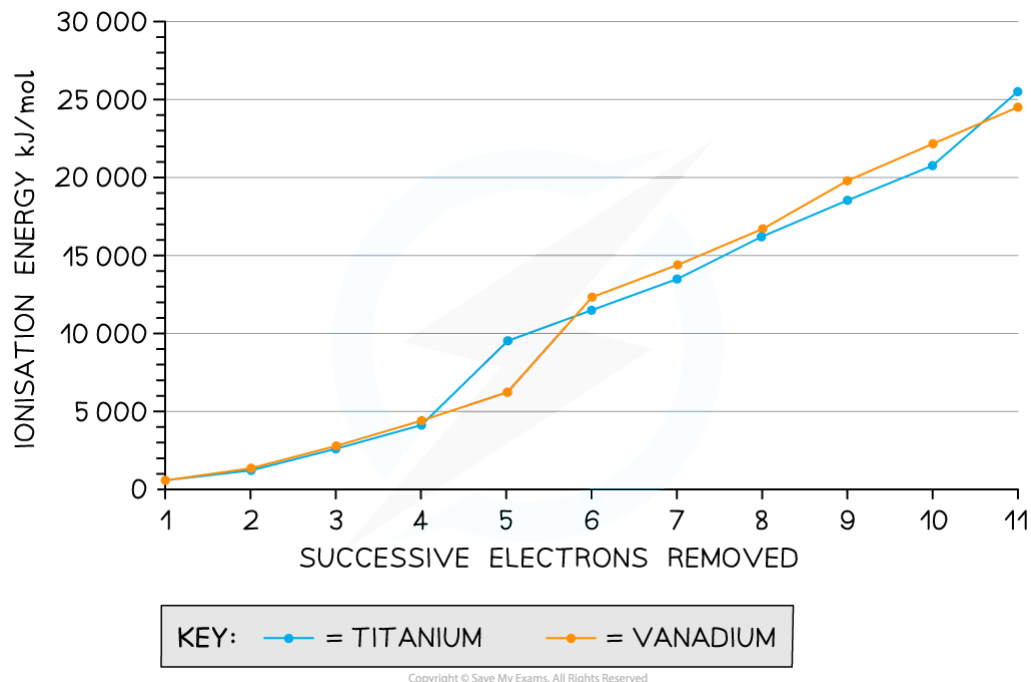
Copyright © Save My Exams. All Rights Reserved



YOUR NOTES



### ***Ionisation energies for the removal of successive electrons in titanium and vanadium***

- We can see from the graph that the first few **ionisation energies** are relatively small and relatively close together
- This means that the energy difference associated with removing a small number of electrons enables transition metals to vary their oxidation state with ease
- The +2 and +3 oxidation state is shown by all the transition elements although the +3 state is more stable up to chromium and the +2 state more stable in the later elements
- Transition metal ions with oxidation state +3 and above tend to be polarising and have a degree of covalent character in the bonds they form. The ions have a high charge density and pull electrons towards themselves
- The maximum oxidation state possible corresponds the total number of electrons in the 4s and 3d which reaches a maximum at manganese
  - An example you may be familiar with is the manganate(VII) ion,  $\text{MnO}_4^-$  which is a powerful oxidising agent



### **Exam Tip**

Common oxidation charges on transition metal ions are given in section 9 of the data booklet, and common oxidation states are given in section 14.

## 13.1.3 Complex Ions

YOUR NOTES



## Complex Ions

- Transition element ions can form complexes which consist of a **central metal ion** and **ligands**
- A ligand is a molecule or ion that forms a co-ordinate bond with a transition metal by donating a pair of electrons to the bond
  - This is also the definition of a **Lewis base**
- This means ligands have a negative charge or a lone pair of electrons capable of being donated
  - This definition may seem familiar: a ligand is the same as a **nucleophile**
- Different **ligands** can form different numbers of dative bonds to the central metal ion in a complex
  - Some ligands can form **one** co-ordinate bond to the central metal ion
  - Other ligands can form **two** co-ordinate bonds, and some can form **multiple** dative bonds
- **Co-ordination number** is number of co-ordinate bonds to the central metal atom or ion

### Common Ligands

- Water molecules frequently act as ligands. Each water molecule makes a single bond with the metal ion using one of the lone pairs on the oxygen atom
- The lone pair is donated to the partially filled d-subshell of the transition metal ion

Table showing examples of common monodentate ligands

Name of Ligand	Formula of Ligand
Water	H <sub>2</sub> O
Ammonia	NH <sub>3</sub>
Chloride	Cl <sup>-</sup>
Cyanide	CN <sup>-</sup>
Hydroxide	OH <sup>-</sup>

Copyright © Save My Exams. All Rights Reserved

### Representing complex ions

- Square brackets are used to group together the ligands and metal ion in a representation of the geometrical arrangement
- The overall charge on the complex ion is the sum of the oxidation states of all the species present



- If the ligands are neutral then the overall charge will be the same as the oxidation state of the metal ion

YOUR NOTES

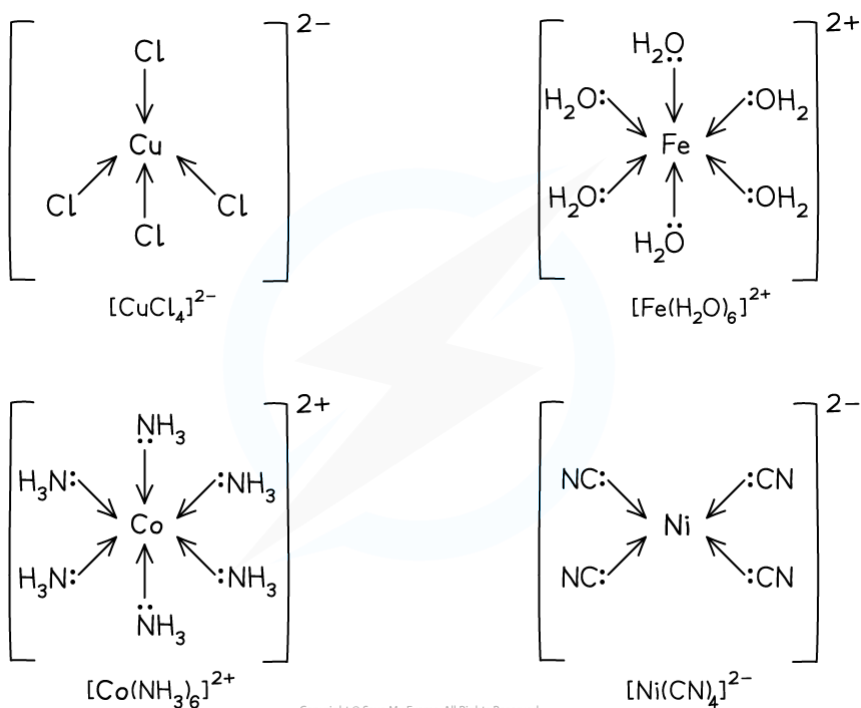

### Examples of complexes with monodentate ligands

### Co-ordination number

- The coordination number is the number of coordinate bonds to the metal ions
- This number can be the same as the number of ligands if they are monodentate, but it could be different if bi- or multidentate ligands are present

### Naming complexes

- Complexes are named in the following way
- If the overall ion is a cation then the nomenclature is:

#### Prefix for number of ligands/ligand name/element/oxidation number

- The prefixes are the same ones used in organic chemistry: di, tetra, hexa for 2, 4 & 6 respectively (3 & 5 are rarely encountered except in mixed ligand complexes)
- If the overall ion is an anion, the name of element is modified to have the name ending 'ate' and sometimes Latin word stems are used
- Using the examples in the illustration above, the names are:
  - tetrachlorocuprate(II)
  - hexaaquairon(II)
  - hexaamminecobalt(II)
  - tetracyanonickelate(II)
- Notice in these examples that

- cuprate (Latin - cuprum) and nickelate are used in place of copper and nickel as they are anions
- Ammonia takes the prefix ammine as a ligand, which is spelt with a double 'm' unlike the functional group amine

YOUR NOTES



## Bidentate Ligands

- **Bidentate** ligands can each form **two** co-ordinate bonds to the central metal ion
- This is because each ligand contains **two** atoms with lone pairs of electrons
- Examples of bidentate ligands are:
  - 1,2-diaminoethane ( $\text{H}_2\text{NCH}_2\text{CH}_2\text{NH}_2$ ) which is also written as '**en**'
  - Ethanedioate ion ( $\text{C}_2\text{O}_4^{2-}$ ) which is sometimes written as '**ox**' (coming from the common name of oxalate)

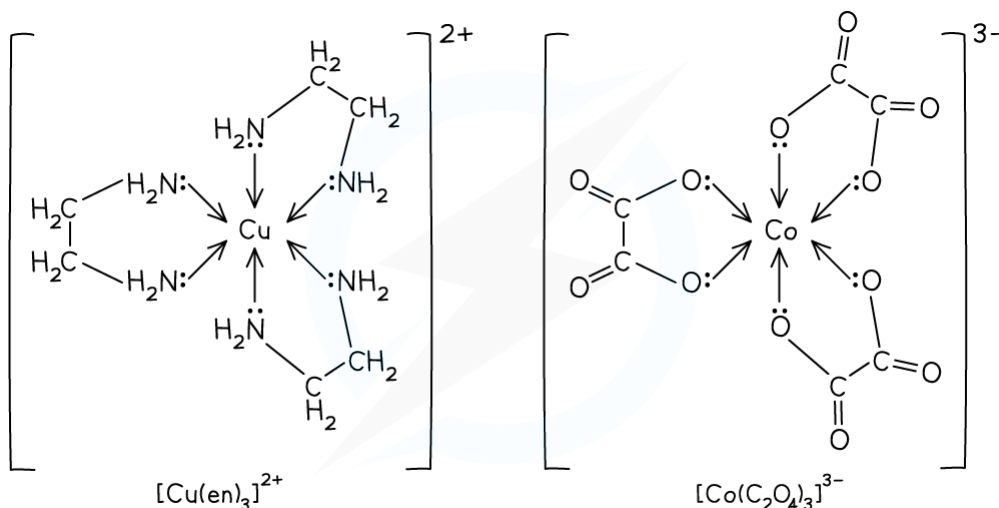

Copyright © Save My Exams. All Rights Reserved

### Examples of complexes with bidentate ligands

## Multidentate Ligands

- Some ligands contain more than two atoms with lone pairs of electrons
- These ligands can form more than two dative bonds and are said to be **multidentate** or **polydentate** ligands
- An example of a multidentate ligand is  $\text{EDTA}^{4-}$ , which is a **hexadentate** ligand as it forms 6 dative covalent bonds to the central metal ion
- EDTA comes from **ethylene diamine tetraacetic acid**, which is rather a mouthful so EDTA is easier!

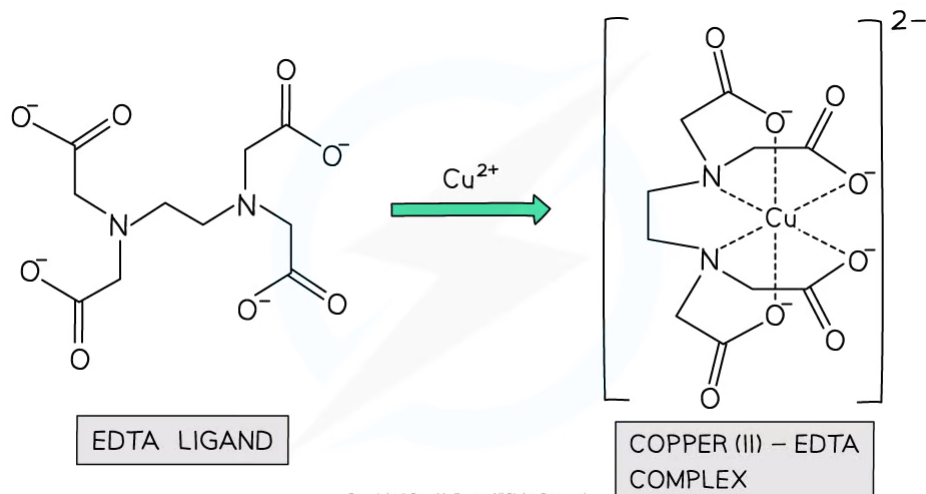

**Example of a polydentate ligand complex**

YOUR NOTES



## Deducing the Charge on a Complex Ion

- You can deduce the charge on a complex ion if you know the charges on the ligands and the oxidation state of the transition metal ion



### Worked Example

The three formulas shown are compounds of chromium(III). What are the charges on the complex ions shown?

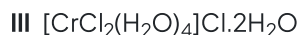
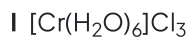

- A** 0, 0, 0  
**B** 1+, 2+, 3+  
**C** 2+, 3+, 1+  
**D** 3+, 2+, 1+

### Answer

The correct option is **D**

- The water molecules do not contribute to the charge
- The chloride ion,  $\text{Cl}^-$ , outside the square brackets must balance against the charge on the complex
- $[\text{Cr}(\text{H}_2\text{O})_6]\text{Cl}_3$  contains three chloride ions, so the charge on the complex is 3+
- $[\text{CrCl}(\text{H}_2\text{O})_5]\text{Cl}_2 \cdot \text{H}_2\text{O}$  contains two chloride ions outside the square bracket, so the charge on the complex is 2+
- $[\text{CrCl}_2(\text{H}_2\text{O})_4]\text{Cl} \cdot 2\text{H}_2\text{O}$  contains one chloride ion outside the square bracket, so the charge on the complex is 1+

YOUR NOTES



### 13.1.4 Catalytic & Magnetic Properties

YOUR NOTES



#### Catalytic Properties

- Transition metals are often used as catalysts in the elemental form or as compounds
  - The ability of transition metals to form more than one stable oxidation state means that they can accept and lose electrons easily
  - This enables them to catalyse certain redox reactions. They can be readily oxidised and reduced again, or reduced and then oxidised again, as a consequence of having a number of different oxidation states of similar stability
  - There are two types of catalyst:
    - A **heterogeneous** catalyst is in a different physical state (phase) from the reactants
      - The reaction occurs at active sites on the surface of the catalyst
      - An example is the use of iron, Fe, in the Haber process for making ammonia
- $$\text{N}_2(\text{g}) + 3\text{H}_2(\text{g}) \rightleftharpoons 2\text{NH}_3(\text{g})$$
- A **homogeneous** catalyst is in the same physical state (phase) as the reactants

#### Further Examples of transition metal catalysts

- The hydrogenation or reduction of alkenes makes use of a nickel catalyst

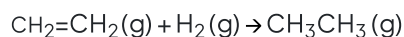

- The same reaction is used in the hydrogenation of vegetable oils to form polyunsaturated fats
- The decomposition of hydrogen peroxide is a common reaction in the study of chemical kinetics and uses manganese(IV) oxide as the catalyst

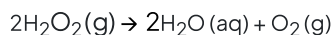

#### Catalytic converters

- Catalytic converters are used in car exhaust boxes to reduce air pollution. They usually consist of a mixture of finely divided platinum and rhodium supported on a ceramic base

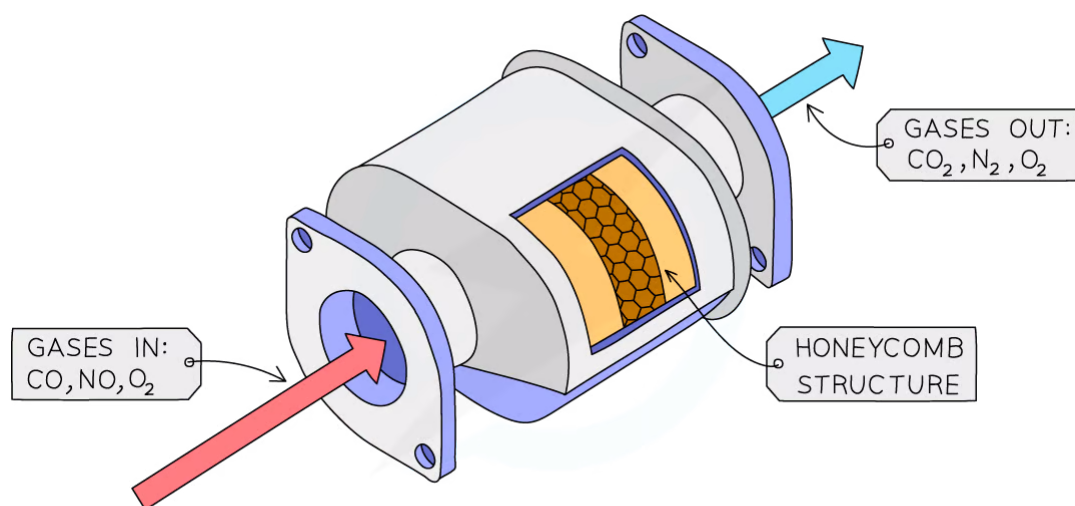

Copyright © Save My Exams. All Rights Reserved



**Diagram of a catalyst on an inert support medium in a vehicle catalytic converter**

- Carbon monoxide, nitrogen dioxide and unburnt hydrocarbons are sources of pollution in car exhaust
- The transition metal catalysts facilitate the conversion of these pollutants into less harmful products

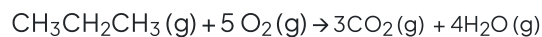
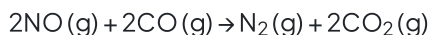

- Some of the transition metals are precious metals so they can be very expensive
- In order to minimise the cost and maximise the efficiency of the catalyst the following measures can be taken:
  - Increasing the surface area of the catalyst
  - Coating an inert surface medium with the catalyst to avoid using large amounts of the catalyst
- This is achieved by spreading the catalyst over a hollow matrix such as a honeycomb-like structure

**Biological catalysts**

- Many of the enzyme catalysed reactions in the body make use of homogeneous transition metal catalysts
- An example of this is haemoglobin, abbreviated to Hb, which transports oxygen around the blood

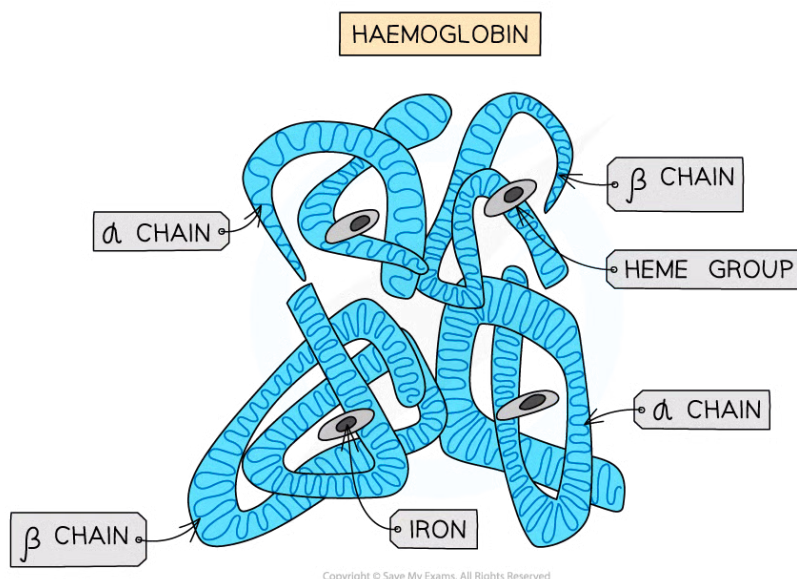

**The structure of haemoglobin**

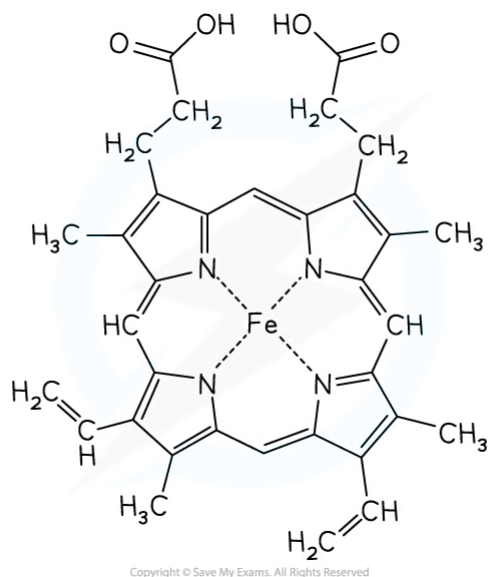

**The structure of haem**

- The iron(II) ion is in the centre of a large heterocyclic ring called a **porphyrin**
- The iron has a coordination number of four, is square planar and can bind to one oxygen molecule
- The Hb molecule contains four porphyrin rings so each Hb can transport four oxygen molecules

## Magnetic Properties

- Materials are classified as **diamagnetic**, **paramagnetic** or **ferromagnetic** according to their behaviour when placed in an external magnetic field
- Diamagnetism** is a property of all materials and produces a very weak opposition to an applied magnetic field
  - It arises from the repulsion of electrons to the applied magnetic field
- Paramagnetism** only occurs in substances which have unpaired electrons
  - It produces magnetisation proportional to the applied field and in the same direction
  - Transition metal complexes show paramagnetism
- Ferromagnetism** has the largest effect and produces magnetisation greater than the applied field

### Diamagnetism

- The atoms of diamagnetic materials have paired electrons
- Spinning electrons create a tiny magnetic dipole
- The paired electrons orientate themselves so that the magnetic field they create opposes the external field
- This result is a very weak repulsion force



Copyright © Save My Exams. All Rights Reserved

**Argon is diamagnetic with the electron configuration  $1s^2 2s^2 2p^6 3s^2 3p^6$**

- Many molecules are diamagnetic since all the electrons are paired up in bonds
- It is very hard to demonstrate diamagnetism but it is possible by suspending a sample of the material from a sensitive force meter and lowering it into a strong horseshoe magnet - a slight change in the force should be seen

### Paramagnetism

- Paramagnetic materials are attracted to an external magnetic field
- The unpaired electrons can be temporarily aligned to the magnetic field causing attraction into the field



Copyright © Save My Exams. All Rights Reserved

**The electrons in titanium are arranged in their orbitals as shown. The unpaired electrons can be temporarily aligned in an external field.**

- Most of the transition metals and their ions are paramagnetic as they have unpaired electrons
- Paramagnetism increases with the number of unpaired electrons, so it generally increases across the d-block up to a maximum with chromium and then decreases





- Zinc has no unpaired electrons so is not paramagnetic

YOUR NOTES



		4s	3d				
Sc	[Ar]	↑↓	↑				
Ti	[Ar]	↑↓	↑	↑			
V	[Ar]	↑↓	↑	↑	↑		
Cr	[Ar]	↑	↑	↑	↑	↑	↑
Mn	[Ar]	↑↓	↑	↑	↑	↑	↑
Fe	[Ar]	↑↓	↑↓	↑	↑	↑	↑
Co	[Ar]	↑↓	↑↓	↑↓	↑	↑	↑
Ni	[Ar]	↑↓	↑↓	↑↓	↑↓	↑	↑
Cu	[Ar]	↑	↑↓	↑↓	↑↓	↑↓	↑↓
Zn	[Ar]	↑↓	↑↓	↑↓	↑↓	↑↓	↑↓

Copyright © Save My Exams. All Rights Reserved

**Orbital diagrams for the first row d-block showing the number of unpaired electrons increasing up to chromium**

## Ferromagnetism

- The metals iron, cobalt and nickel show the unusual property of **ferromagnetism**
- The alignment of the unpaired electrons in an external field in ferromagnetic materials can be retained so the material becomes permanently magnetised
- If ferromagnetic materials are heated and cooled in a magnetic field, the magnetic field of the electrons remains
- Magnetic regions within the metal that are aligned magnetically are known as **domains**
- Banging or heating a permanent magnet will weaken the magnetism

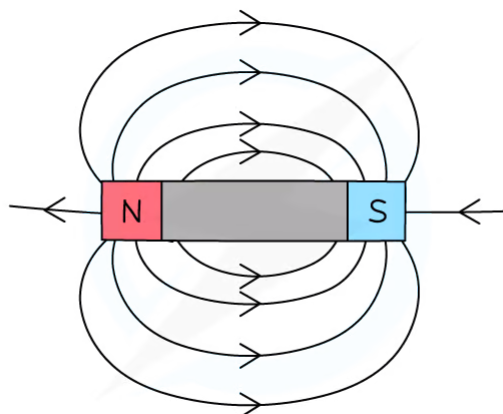

Copyright © Save My Exams. All Rights Reserved

***Ferromagnetic materials are used to make permanent magnets which produce characteristic magnetic field lines***

YOUR NOTES





## Crystal Field Theory

### Perception of colour

- Most transition metal compounds appear coloured. This is because they absorb energy corresponding to certain parts of the visible **electromagnetic spectrum**
- The colour that is seen is made up of the parts of the visible spectrum that aren't absorbed
- For example, a green compound will absorb all frequencies of the spectrum apart from green light, which is transmitted
- The colours absorbed are **complementary** to the colour observed

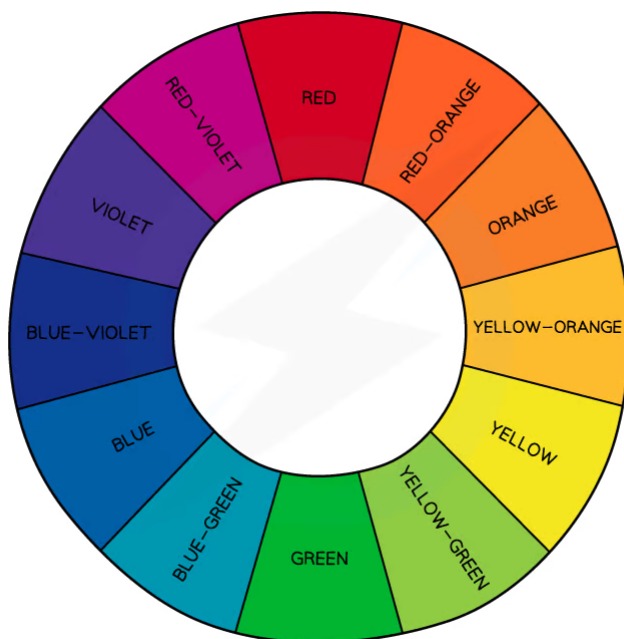

Copyright © Save My Exams. All Rights Reserved

### *The colour wheel showing complementary colours in the visible light region of the electromagnetic spectrum*

- Complementary colours are any two colours which are directly opposite each other in the colour wheel
  - For example, the complementary colour of red is green and the complementary colours of red-violet are yellow-green

### Crystal Field Theory (CFT)

- The crystal field theory is a model based on electrostatic point charges and is used to explain colour in transition metal compounds
- In a transition metal atom, the five orbitals that make up the d-subshell all have the same energy. The term for this is **degenerate**
- However, when ligands are attached to a transition metal ion, the electric field formed by the lone pairs of electrons on the ligands repel the electrons in the d-subshell causing the d-orbitals to split in energy
- The dative bonding from the ligands causes the five d orbitals to split into two sets

- These two sets are **not** equal in energy and are described as being **non-degenerate orbitals**

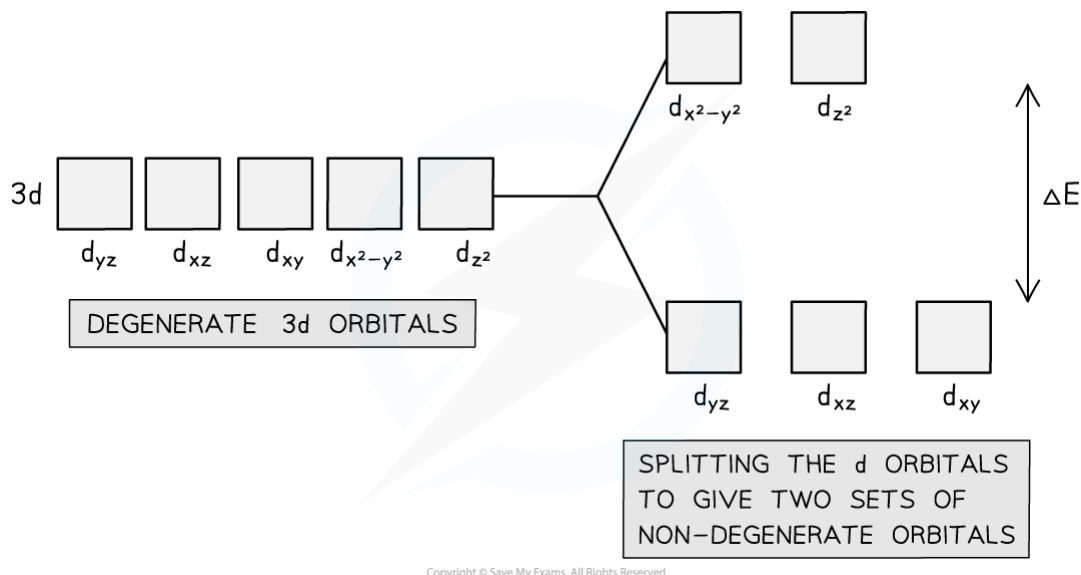

Copyright © Save My Exams. All Rights Reserved

**Upon bonding to ligands, the d orbitals of the transition element ion split into two non-degenerate sets of orbitals**

### Splitting in octahedral complexes

- In **octahedral** complexes, there are six ligands arranged around the **central metal ion**
- The lone pairs of the ligands repel the electrons in the  $x^2-y^2$  and  $z^2$  orbitals of the metal ion **more than** they repel the electrons in the  $3d_{yz}$ ,  $3d_{xz}$ , and  $3d_{xy}$  orbitals
- This is because the  $3d_{x^2-y^2}$  and  $3d_{z^2}$  orbitals line up with the dative bonds in the complex's octahedral shape
- The incoming ligands are attached to or approaching the central metal ion along the x, y and z axes, and the  $3d_{x^2-y^2}$  and  $3d_{z^2}$  orbitals have lobes along these axes
- The electrons in these two orbitals are closer to the bonding electrons, so there is more **repulsion**
- This means that when the d orbitals split, the  $3d_{x^2-y^2}$  and  $3d_{z^2}$  orbitals are at a slightly higher energy level than the other three
- The difference in energy between the **non-degenerate** d orbitals is labelled as  $\Delta E$

YOUR NOTES



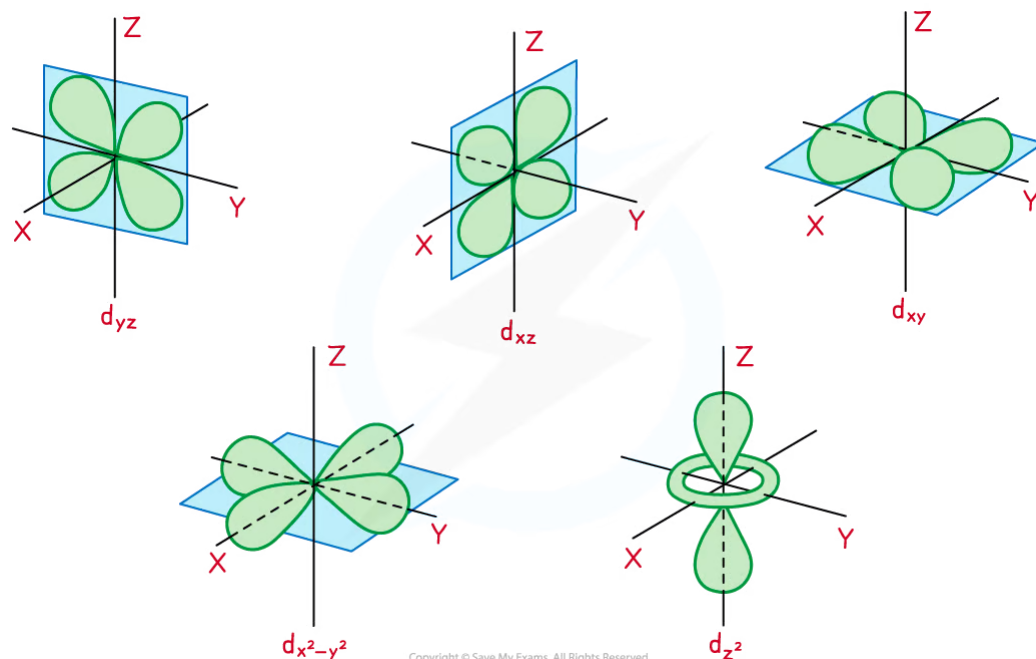

**Diagram showing the shapes and orientation of the five d-orbitals**

### Absorption of light

- When white light passes through a solution of aqueous nickel(II) sulfate an electron in the lower energy d-orbitals is excited and jumps up into the higher energy d-orbitals
- A **photon** of red light is absorbed and light of the complementary colour (green) is transmitted
- This is why nickel(II) sulfate solution appears green
- The energy of the separation is  $\Delta E$  corresponding to a wavelength of about 630–700 nm

YOUR NOTES



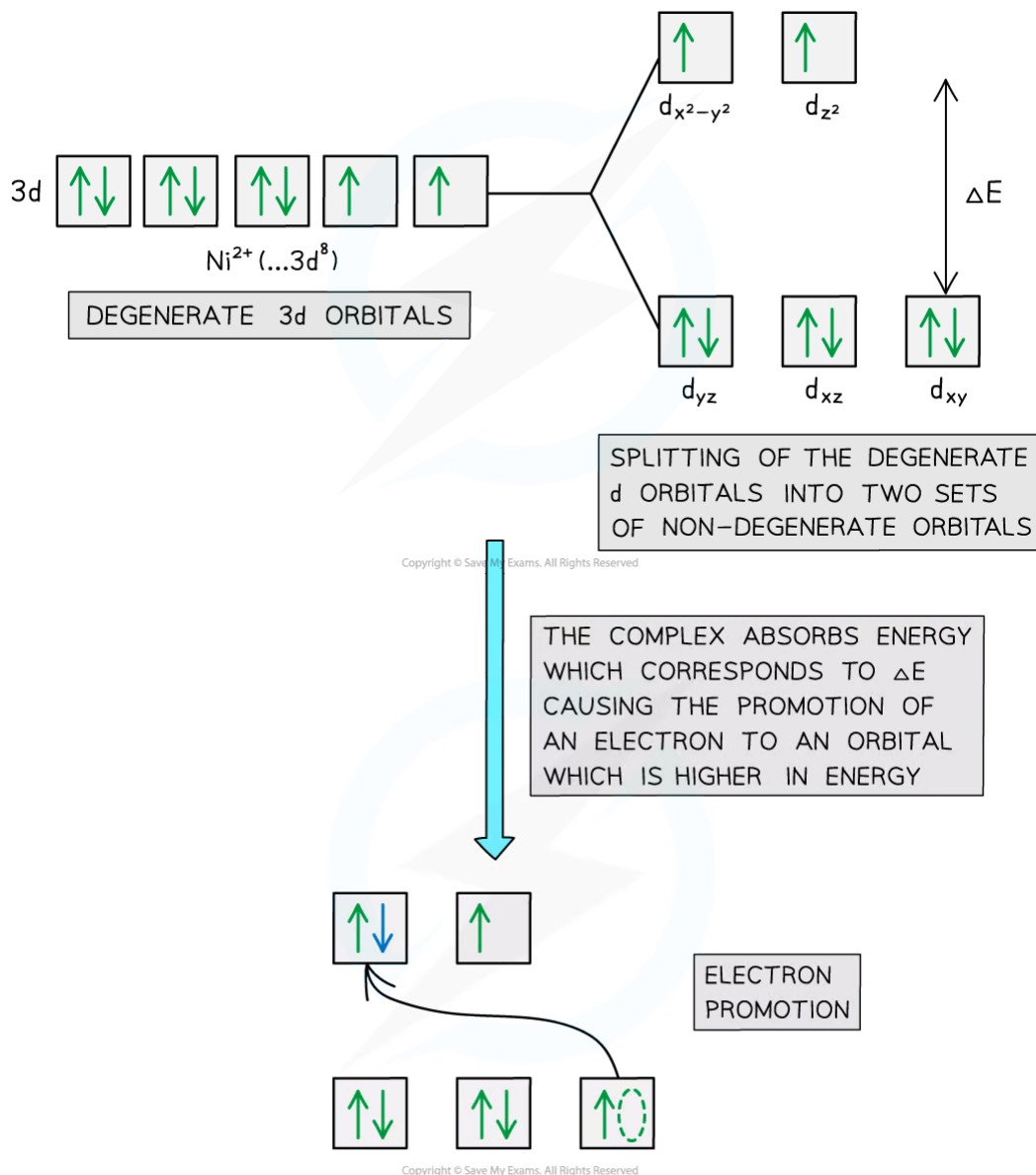

**Electron promotion in a Ni(II) complex when light shines on the solution**



**Exam Tip**

The colour wheel is given in Section 17 of the Data booklet, so there is no need to learn it. There are different splitting patterns possible but you are only required to know the octahedral splitting pattern discussed above.

## 13.1.6 Factors Affecting Colour

YOUR NOTES

**Factors Affecting Colour**

- The size of the splitting energy  $\Delta E$  in the d-orbitals is influenced by the following four factors:
  - The size and type of ligands
  - The nuclear charge and identity of the metal ion
  - The oxidation state of the metal
  - The shape of the complex

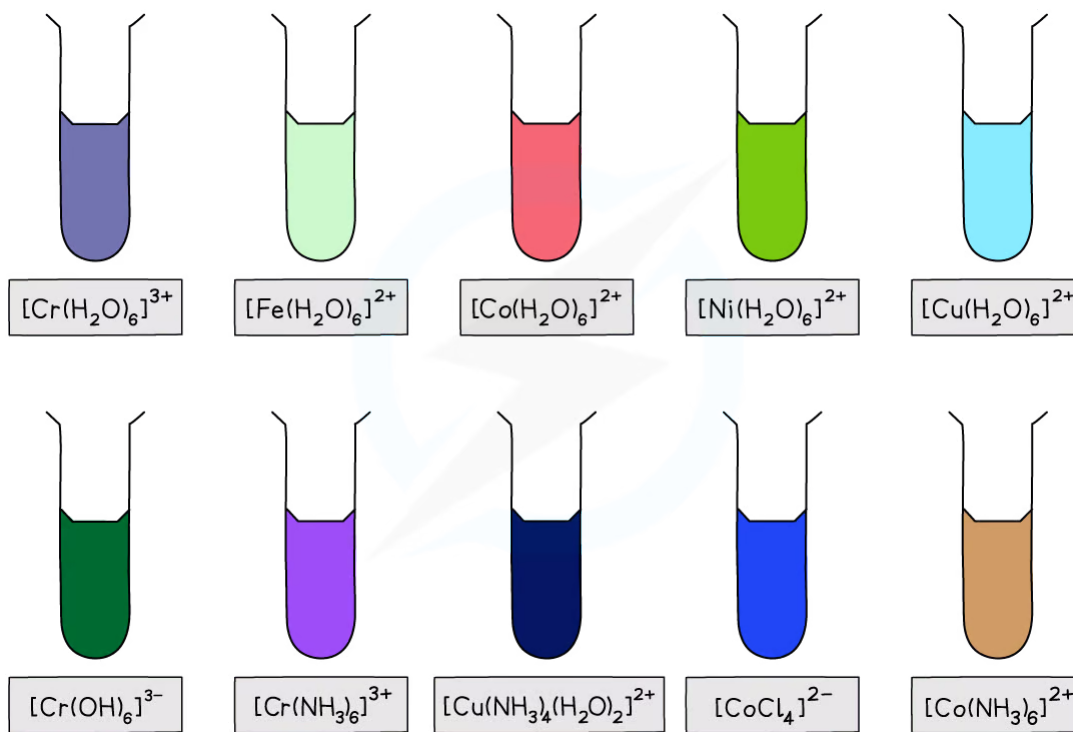

*The large variety of coloured compounds is a defining characteristic of transition metals*

**Size and type of ligand**

- The nature of the ligand influences the strength of the interaction between ligand and central metal ion
- Ligands vary in their charge density
- The greater the charge density; the more strongly the ligand interacts with the metal ion causing greater splitting of the d-orbitals
- The further it is then shifted towards the region of the spectrum where it absorbs higher energy
- As a result, a different colour of light is absorbed by the complex solution and a different **complementary colour** is observed
- This means that complexes with the same **transition elements ions**, but **different ligands**, can have different colours
  - For example, the  $[\text{Cu}(\text{H}_2\text{O})_6]^{2+}$  complex has a **light blue** colour

- Whereas the  $[\text{Cu}(\text{NH}_3)_4(\text{H}_2\text{O})_2]^{2+}$  has a **dark blue** colour despite the copper(II) ion having an oxidation state of +2 in both complexes

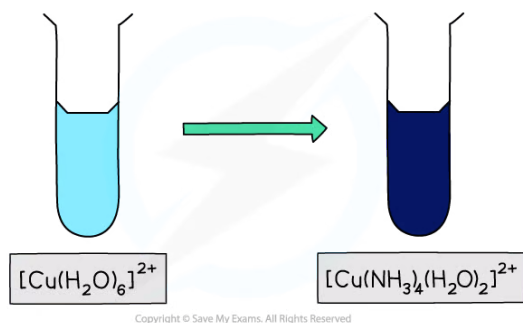

**Ligand exchange of the water ligands by ammonia ligands causes a change in colour of the copper(II) complex solution**

- Ammonia has a greater charge density than water and so produces a larger split in the d-orbitals

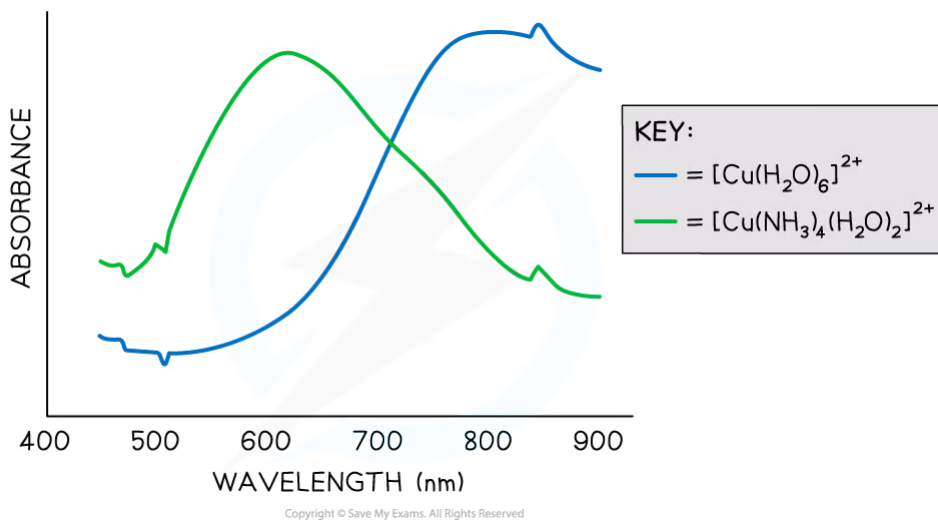

**Graph showing the replacement of the water molecules with four ammonia molecules causes a shift in maximum absorbance towards shorter wavelength**

**The nuclear charge**

- The strength of the attraction between the metal ion and lone pairs of electrons from the ligand can vary depending on the **effective nuclear charge** on the metal ion
- For example, aqueous Mn(II) and Fe(III) have the same electronic configuration:



- Mn(II) (Z=25) absorbs in the green region of the spectrum so appears pink
- The higher effective nuclear charge on Fe(III) (Z= 26) causes a stronger interaction with the ligands, so it absorbs in the higher energy blue part of the spectrum and appears yellow/orange in colour

**Oxidation state**

YOUR NOTES





- When the same metal is in a higher oxidation state that will also create a stronger interaction with the ligands
- If you compare iron(II) and iron (III):
  - $[\text{Fe}(\text{H}_2\text{O})_6]^{2+}$  absorbs in the red region and appears green
  - But,  $[\text{Fe}(\text{H}_2\text{O})_6]^{3+}$  absorbs in blue region and appears orange

## Shape

- The change of colour in a complex is also partly due to the change in coordination number and geometry of the complex ion
- The splitting energy,  $\Delta E$ , of the d-orbitals is affected by the relative orientation of the ligand as well as the d-orbitals
- Changing the coordination number generally involves changing the ligand as well, so it is a combination of these factors that alters the strength of the interactions



YOUR NOTES



## The Spectrochemical Series

- The Japanese chemist, R. Tuschida, proposed a ranking of ligands based on their ability to separate the two sets of d-orbitals
- This is known as the **spectrochemical series**
- The higher the charge density of the ligand; the more strongly it influences the splitting of the d-orbitals so the greater the energy difference between them

Table showing the spectrochemical series for common ligands

Ligand	$I^-$	$Br^-$	$S^{2-}$	$Cl^-$	$H_2O$	$OH^-$	$NH_3$	$CN^-$	CO
Separation energy, $\Delta E$	Weakest field								Strongest field
Wavelength, $\lambda$	Longest								Shortest

Copyright © Save My Exams. All Rights Reserved

- You can see at either end of the series lies iodide ions,  $I^-$ , and carbon monoxide, CO
- Iodide ions are large (think how many electron shells they have) so they have a relative low charge density and produce the weakest electric field so the separation energy of the d-orbitals is the smallest in the series
- Chloride ions,  $Cl^-$ , on the other hand are smaller, have a higher charge density and consequently produce a large separation energy
- However, size is not the only factor as carbon monoxide and cyanide ions produce a larger splitting due to complex interactions involving the pi bonds present in those molecules; those interactions occur when electrons in the d-orbitals of the transition metal interact with electrons in the p-orbitals of the ligands
- You should be able to see why adding ammonia to aqueous copper(II) ions results in a darker blue complex
  - Ammonia is a stronger ligand than water so the separation energy is larger and the wavelength of absorbed light shorter
  - Shorter wavelength means moving towards to bluer higher energy end of the visible spectrum



### Exam Tip

You do not need to learn the spectrochemical series as it is given in the data booklet in section 15. A list of polydentate ligands is also given in the data booklet in section 16.

YOUR NOTES

