

# IB Chemistry DP

YOUR NOTES



## 4. Chemical Bonding & Structure

### CONTENTS

- 4.1 Ionic & Covalent Bonding
  - 4.1.1 Forming Ions
  - 4.1.2 Ionic Compounds
  - 4.1.3 Formulae & Names of Ionic Compounds
  - 4.1.4 Covalent Bonds
  - 4.1.5 Bond Polarity
  - 4.1.6 Lewis Structures
- 4.2 Resonance, Shapes & Giant Structures
  - 4.2.1 Resonance Structures
  - 4.2.2 Shapes of Molecules
  - 4.2.3 Predicting Molecular Shapes
  - 4.2.4 Molecular Polarity
  - 4.2.5 Giant Covalent Structures
- 4.3 Intermolecular Forces & Metallic Bonding
  - 4.3.1 Types of Intermolecular Forces
  - 4.3.2 Deducing Intermolecular Forces
  - 4.3.3 Properties of Covalent Compounds
  - 4.3.4 Metallic Bonding
  - 4.3.5 Trends in Melting Points of Metals
  - 4.3.6 Alloys & their Properties

## 4.1 Ionic & Covalent Bonding

### 4.1.1 Forming Ions

#### Forming Ions

- As a general rule, **metals** are on the **left** of the Periodic Table and **non-metals** are on the **right-hand** side
- Ionic bonds** involve the **transfer** of electrons from a **metallic** element to a **non-metallic** element
- Transferring electrons usually leaves the metal and the non-metal with a **full outer shell**
- Metals **lose** electrons from their valence shell forming positively charged **cations**
- Non-metal atoms **gain** electrons forming negatively charged **anions**
- Once the atoms become ions, their electronic configurations are the same as a noble gas.
  - A sodium ion ( $\text{Na}^+$ ) has the same electronic configuration as neon: [2,8]
  - A chloride ion ( $\text{Cl}^-$ ) also has the same electronic configuration as argon: [2,8,8]

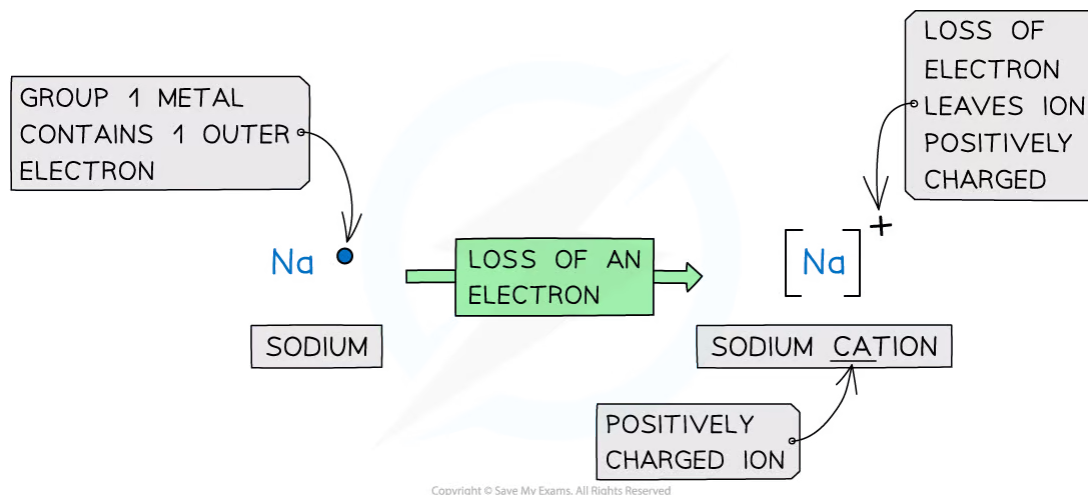

**Forming cations by the removal of electrons from metals**

YOUR NOTES



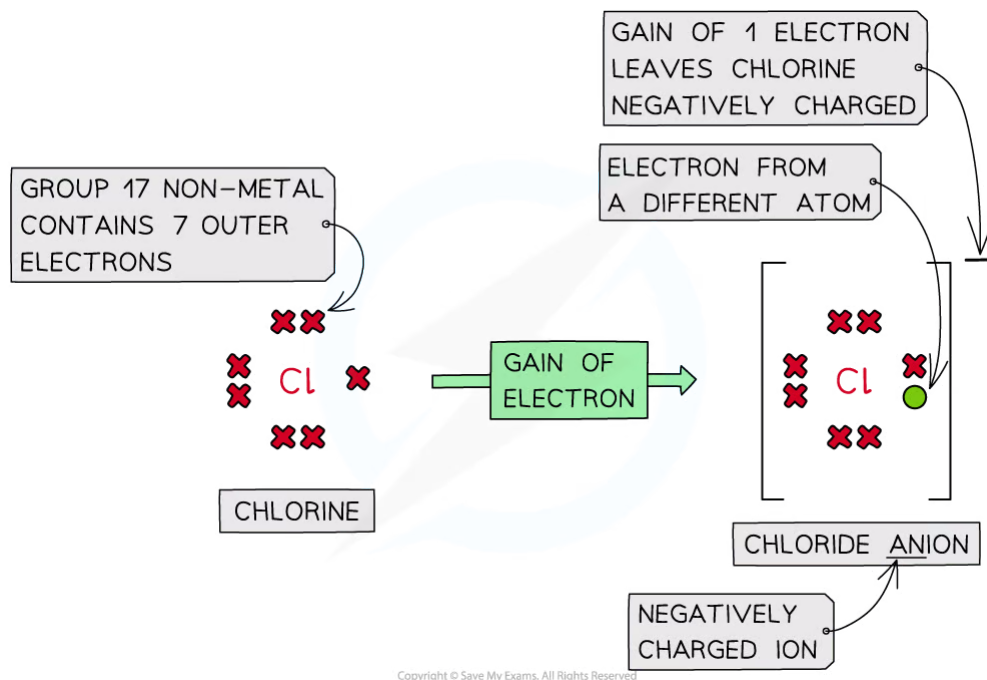

**Forming anions by the addition of electrons to nonmetals**

- **Cations** and **anions** are oppositely charged and therefore attracted to each other
- **Electrostatic attractions** are formed between the oppositely charged ions to form **ionic compounds**
- This form of attraction is very **strong** and requires a lot of energy to overcome
  - This causes high melting points in ionic compounds

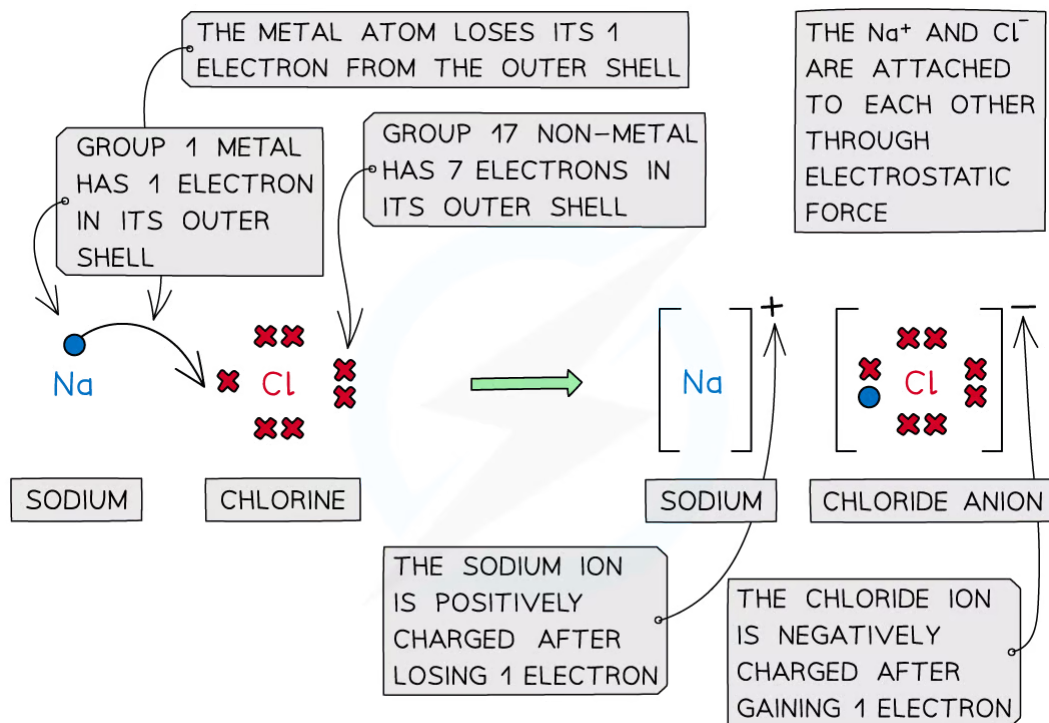

**Cations and anions bond together using strong electrostatic forces, which require a lot of energy to overcome**



**Exam Tip**

**Metals** usually **lose** all electrons from their outer valence shell to become **cations**. You can make use of the groups on the periodic table to work out how many electrons an atom is likely to lose or gain by looking at the **group** an atom belongs to.

4.1.2 Ionic Compounds

YOUR NOTES



### Ionic Lattices

- The ions form a **lattice structure** which is an evenly distributed **crystalline** structure
- Ions in a lattice are arranged in a **regular repeating pattern** so that positive charges cancel out negative charges
- Therefore the final lattice is overall electrically **neutral**

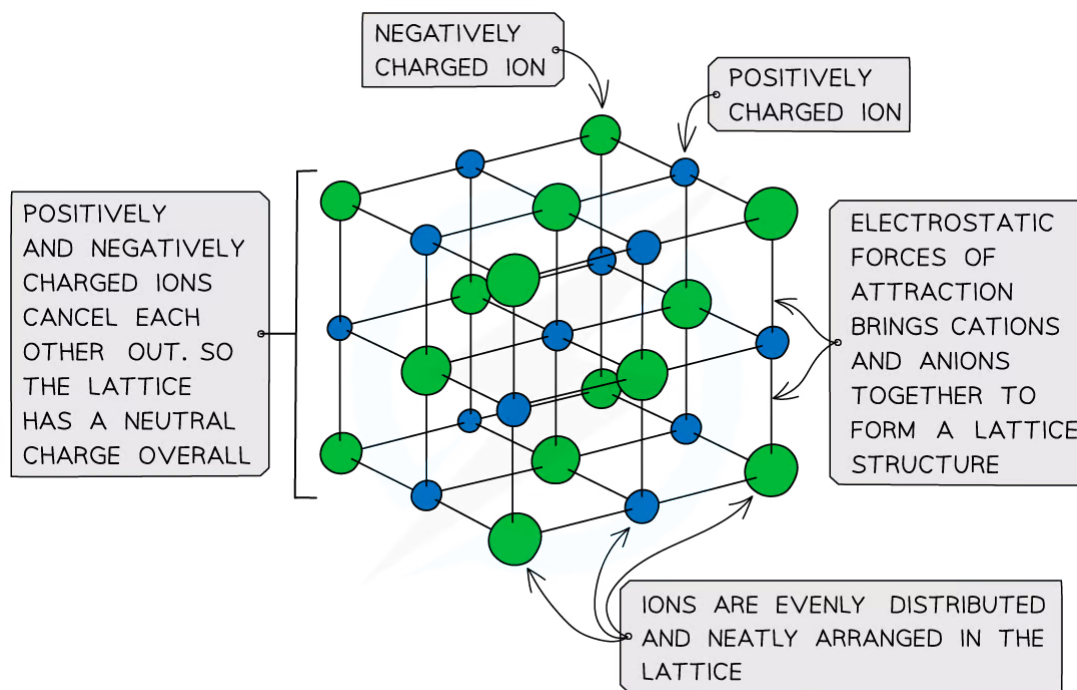

*Ionic solids are arranged in lattice structures*

## Properties of Ionic Compounds

- Different types of **structure** and **bonding** have different effects on the **physical properties** of substances such as their **melting** and **boiling points**, **electrical conductivity** and **solubility**

### Ionic bonding & giant ionic lattice structures

- Ionic compounds are **strong**
  - The **strong electrostatic forces** in ionic compounds keep the ions strongly together
- They are **brittle** as ionic crystals can split apart
- Ionic compounds have **high melting** and **boiling points**
  - The strong electrostatic forces between the ions in the lattice act in all directions and keep them strongly together
  - Melting and boiling points increase with charge density of the ions due to the greater **electrostatic attraction** of charges
  - $\text{Mg}^{2+}\text{O}^{2-}$  has a higher melting point than  $\text{Na}^+\text{Cl}^-$
- Ionic compounds are **soluble** in water as they can form **ion – dipole bonds**
- Ionic compounds only **conduct electricity** when **molten** or in **solution**
  - When molten or in solution, the ions can freely move around and conduct electricity
  - In the solid state they're in a fixed position and unable to move around

### Characteristics of Giant Ionic Lattices compared to other Structures

YOUR NOTES



YOUR NOTES



	Giant Ionic	Giant Metallic	Simple Covalent	Giant Covalent
<b>Melting and Boiling Points</b>	High	Moderately high to high	Low	Very high
<b>Electrical Conductivity</b>	Only when molten or in solution	When solid or liquid	Do not conduct electricity	Do not conduct electricity (except for graphite)
<b>Solubility</b>	Soluble	Insoluble but some may react	Usually insoluble unless they are polar	Insoluble
<b>Hardness</b>	Hard, brittle	Hard, malleable	Soft	Very hard (diamond and SiO <sub>2</sub> ) or soft (graphite)
<b>Physical State at Room Temperature</b>	Solid	Solid	Solid, liquid or gas	Solid
<b>Forces</b>	Electrostatic attraction between ions	Delocalised sea of electrons attracting positive ions	Weak intermolecular forces between molecules and covalent bonds within a molecule	Electrons in covalent bonds between atoms
<b>Particles</b>	Ions	Positive ions in a sea of electrons	Small molecules	Atoms
<b>Examples</b>	NaCl	Copper	Br <sub>2</sub>	Graphite, silicon(IV) oxide

Copyright © Save My Exams. All Rights Reserved



## Worked Example

The table below shows the physical properties of substances X, Y and Z

Substance	Melting Point (°C)	Electrical Conductivity when Molten	Solubility in Water
X	839	Good	Soluble
Y	95	Very poor	Almost insoluble
Z	1389	Good	Insoluble

Copyright © Save My Exams. All Rights Reserved

Which one of the following statements about X and Y is completely true?

**Statement 1:** X has a giant ionic structure, Y has a giant molecular structure, Z is a metal

**Statement 2:** X is a metal, Y has a simple molecular structure, Z has a giant molecular structure

**Statement 3:** X is a metal, Y has a simple molecular structure, Z has a giant ionic structure

**Statement 4:** X has a giant ionic structure, Y has a simple molecular structure, Z is a metal

### Answer:

The correct answer is **Statement 4**

- The relatively high melting point, solubility in water and electrical conductivity when molten suggest that X is an **giant ionic structure**
- The low melting point of Y suggests that little energy is needed to break the lattice which corresponds to a **simple molecular structure**. This is further supported by the low electrical conductivity and almost insoluble in water
- Compound Z has a very high melting point which is characteristic of either metallic or giant molecular lattices, however since it conducts electricity, compound Z must be a **giant metallic lattice**



## 4.1.3 Formulae &amp; Names of Ionic Compounds

YOUR NOTES

**Formulae & Names of Ionic Compounds**

- **Ionic compounds** are formed from a **metal** and a **nonmetal** bonded together
- Ionic compounds are electrically neutral; the positive charges equal the negative charges

**Charges on positive ions**

- All metals form **positive** ions
  - There are some non-metal positive ions such as ammonium,  $\text{NH}_4^+$ , and hydrogen,  $\text{H}^+$
- The **metals** in Group 1, Group 2 and Group 13 have a charge of 1+, and 2+ and 3+ respectively
- The charge on the ions of the **transition elements can vary** which is why **Roman numerals** are often used to indicate their charge
- This is known as **Stock notation** after the German chemist Alfred Stock
- **Roman numerals** are used in some compounds formed from transition elements to show the **charge** (or **oxidation state**) of metal ions
  - Eg. in copper (II) oxide, the copper ion has a charge of 2+ whereas in copper (I) nitrate, the copper has a charge of 1+

**Non-metal ions**

- The **non-metals** in group 15 to 17 have a negative charge and have the suffix '**ide**'
  - Eg. nitride, chloride, bromide, iodide
- Elements in group 17 gain 1 electron so have a 1- charge, eg.  $\text{Br}^-$
- Elements in group 16 gain 2 electrons so have a 2- charge, eg.  $\text{O}^{2-}$
- Elements in group 15 gain 3 electrons so have a 3- charge, eg.  $\text{N}^{3-}$
- There are also more **polyatomic** or **compound negative ions**, which are negative ions made up of more than one type of atom

GROUP								18
1	2	$\text{H}^+$	13	14	15	16	17	NONE
$\text{Li}^+$	$\text{Be}^{2+}$					$\text{O}^{2-}$	$\text{F}^-$	NONE
$\text{Na}^+$	$\text{Mg}^{2+}$		$\text{Al}^{3+}$			$\text{S}^{2-}$	$\text{Cl}^-$	NONE
$\text{K}^+$	$\text{Ca}^{2+}$	TRANSITION ELEMENTS	$\text{Ga}^{3+}$				$\text{Br}^-$	NONE
$\text{Rb}^+$	$\text{Sr}^{2+}$						$\text{I}^-$	NONE

Copyright © Save My Exams. All Rights Reserved

**The charges of simple ions depend on their position in the Periodic Table**

- There are seven polyatomic ions you need to know for IB Chemistry:

**Formulae of Polyatomic Ions Table**

Ion	Formula and Charge
Ammonium	$\text{NH}_4^+$
Hydroxide	$\text{OH}^-$
Nitrate	$\text{NO}_3^-$
Sulfate	$\text{SO}_4^{2-}$
Carbonate	$\text{CO}_3^{2-}$
Hydrogen carbonate	$\text{HCO}_3^-$
Phosphate	$\text{PO}_4^{3-}$

Copyright © Save My Exams. All Rights Reserved

YOUR NOTES



### Worked Example

Determine the formulae of the following ionic compounds

1. magnesium chloride
2. aluminium oxide
3. ammonium sulfate

**Answer:**

#### Answer 1: Magnesium chloride

- Magnesium is in group 2 so has a charge of 2+
- Chlorine is in group 17 so has a charge of 1-
- Magnesium needs two chlorine atoms for each magnesium atom to be balanced so the formula is **MgCl<sub>2</sub>**

#### Answer 2: Aluminium oxide

- Aluminium is in group 13 so the ion has a charge of 3+
- Oxygen is in group 16 so has a charge of 2-
- The charges need to be equal so 2 aluminium to 3 oxygen atoms will balance electrically, so the formula is **Al<sub>2</sub>O<sub>3</sub>**

#### Answer 3: Ammonium sulfate

- Ammonium is a polyatomic ion with a charge of 1+
- Sulfate is a **polyatomic ion** and has a charge of 2-
- The polyatomic ion needs to be placed in a bracket if more than 1 is needed

- The formula of ammonium nitrate is  $(\text{NH}_4)_2\text{SO}_4$



### Exam Tip

Remember: **polyatomic ions** are ions that contain more than one type of element, such as  $\text{OH}^-$

YOUR NOTES



4.1.4 Covalent Bonds

YOUR NOTES



Covalent Bonds

- **Covalent** bonding occurs between two **non-metals**
- A covalent bond involves the **electrostatic attraction** between nuclei of two atoms and the electrons of their outer shells
- **No electrons** are **transferred** but only **shared** in this type of bonding
- When a covalent bond is formed, two **atomic orbitals** overlap and a **molecular orbital** is formed
- Covalent bonding happens because the electrons are more stable when attracted to two nuclei than when attracted to only one

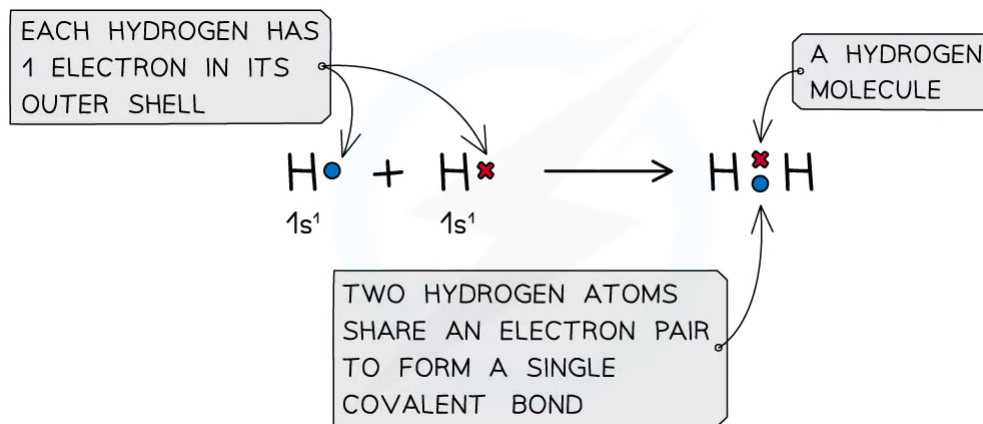

**The positive nucleus of each atom has an attraction for the bonding electrons shared in the covalent bond**

- In a normal covalent bond, each atom provides one of the electrons in the bond. A covalent bond is represented by a short straight line between the two atoms, H-H
- Covalent bonds should not be regarded as shared electron pairs in a fixed position; the electrons are in a state of constant motion and are best regarded as **charge clouds**

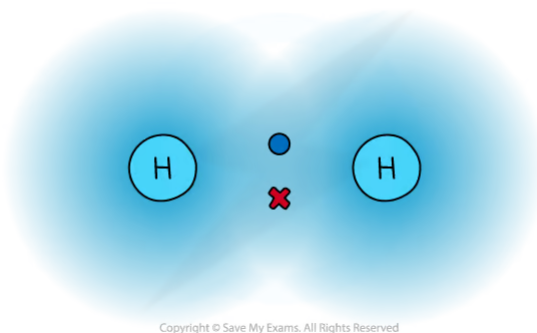

**A representation of electron charge clouds. The electrons can be found anywhere in the charge clouds**

- **Non-metals** are able to **share** pairs of electrons to form different types of covalent bonds

- Sharing electrons in the covalent bond allows each of the 2 atoms to achieve an electron configuration similar to a noble gas
  - This makes each atom more stable
- In some instances, the central atom of a covalently bonded molecule can accommodate **more** or **less** than 8 electrons in its outer shell
  - Being able to accommodate **more** than 8 electrons in the outer shell is known as '**expanding the octet rule**'
  - Accommodating **less** than 8 electrons in the outer shell means that the central atom is '**electron deficient**'
  - Some examples of this can be found in the section on Lewis structures



### Exam Tip

Covalent bonding takes place between two nonmetal atoms. Remember to use the periodic table to decide how many electrons are in the outer shell of a nonmetal atom.

## Predicting Covalent Bonding

- The differences in Pauling electronegativity values can be used to predict whether a bond is **covalent** or **ionic** in character

### Electronegativity & covalent bonds

- In **diatomic molecules** the electron density is shared equally between the two atoms
  - Eg. H<sub>2</sub>, O<sub>2</sub> and Cl<sub>2</sub>
- Both atoms will have the same electronegativity value and have an **equal attraction** for the bonding pair of electrons leading to formation of a **covalent** bond
- A difference of less than around **1.0** in electronegativity values will be associated with covalent bonds, although between 1.0 and 2.0 can be considered polar covalent:

You can use the Pauling scale to decide whether a bond is polar or nonpolar:

Difference in Electronegativity	Bond Type
< 1.0	Covalent
1.0 – 2.0	Polar Covalent
> 2.0	Ionic

Copyright © Save My Exams. All Rights Reserved

YOUR NOTES



## Coordinate Bonds

YOUR NOTES



- In **simple covalent bonds** the two atoms involved share electrons
- Some molecules have a **lone** pair of electrons that can be donated to form a bond with an **electron-deficient** atom
  - An electron-deficient atom is an atom that has an **unfilled outer orbital**
- So **both electrons** are from the **same atom**
- This type of bonding is called **dative covalent bonding** or **coordinate bond**
- An example of a dative bond is in an **ammonium ion**
  - The hydrogen ion,  $H^+$  is **electron-deficient** and has space for two electrons in its shell
  - The nitrogen atom in ammonia has a lone pair of electrons which it can donate to the hydrogen ion to form a dative covalent bond

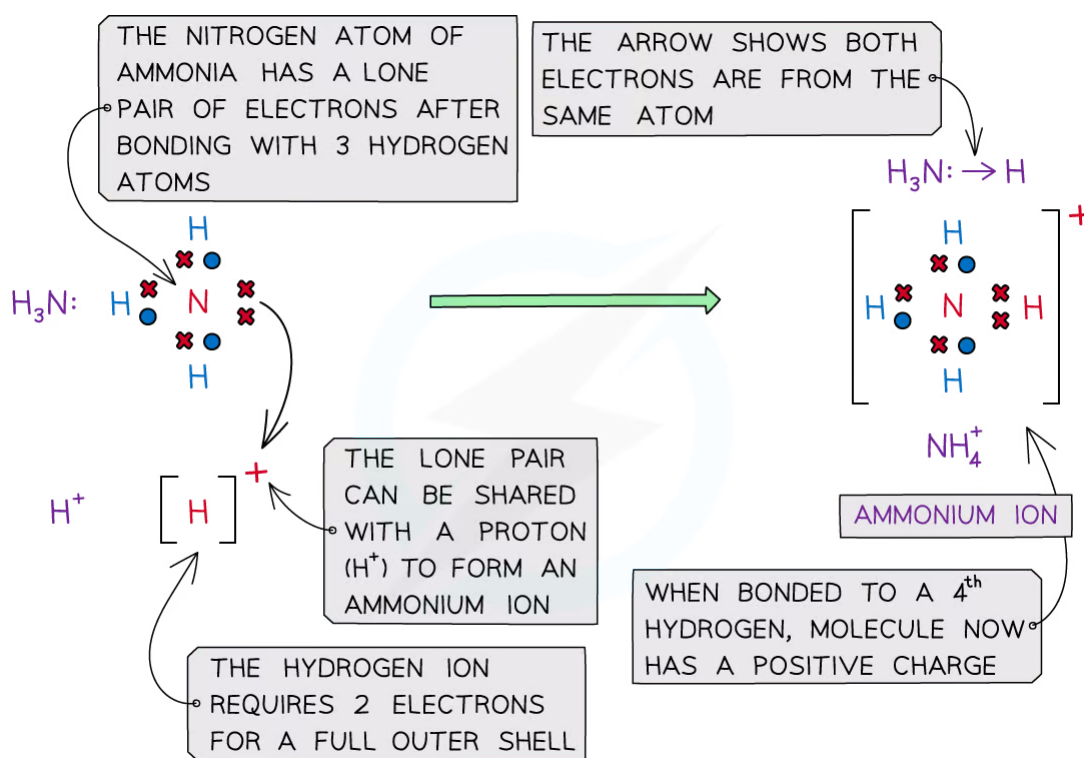

Copyright © Save My Exams. All Rights Reserved

**Ammonia ( $NH_3$ ) can donate a lone pair to an electron-deficient proton ( $H^+$ ) to form a charged ammonium ion ( $NH_4^+$ )**

- More examples of coordinate bonding can be found in the section on **Lewis Structures**

## Multiple Bonds

- **Non-metals** are able to **share** more than one pair of electrons to form different types of covalent bonds
- Sharing electrons in the covalent bond allows each of the 2 atoms to achieve an electron configuration similar to a noble gas
  - This makes each atom more stable
- It is not possible to form a quadruple bond as the repulsion from having 8 electrons in the same region between the two nuclei is too great

Covalent Bonds & Shared Electrons Table

Type of covalent bond	Number of electrons shared
Single (C – C)	2
Double (C = C)	4
Triple (C ≡ C)	6

Copyright © Save My Exams. All Rights Reserved

YOUR NOTES



## Bond Length & Strength

YOUR NOTES



### Bond energy

- The **bond energy** is the energy required to **break** one mole of a particular covalent bond in the gaseous states
  - Bond energy has units of  $\text{kJ mol}^{-1}$
- The **larger** the bond energy, the **stronger** the covalent bond is

### Bond length

- The **bond length** is **internuclear distance of two covalently bonded atoms**
  - It is the distance from the nucleus of one atom to another atom which forms the covalent bond
- The **greater** the forces of attraction between electrons and nuclei, the more the atoms are pulled closer to each other
- This **decreases** the **bond length** of a molecule and **increases** the **strength** of the covalent bond
- Triple bonds** are the **shortest** and **strongest** covalent bonds due to the large electron density between the nuclei of the two atoms
- This increase the forces of attraction between the electrons and nuclei of the atoms
- As a result of this, the atoms are pulled closer together causing a shorter bond length
- The increased forces of attraction also means that the covalent bond is **stronger**

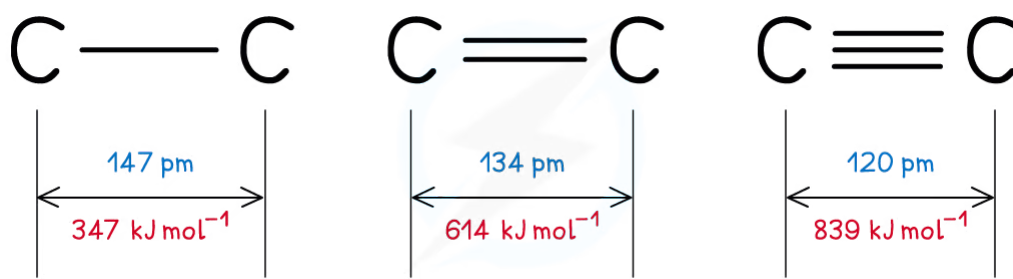

Copyright © Save My Exams. All Rights Reserved

**Triple bonds are the shortest covalent bonds and therefore the strongest ones**

- Test your knowledge of covalent bonding:



### Worked Example

Which molecules react together to form a dative covalent bond?

- $\text{Cl}_2$  and HF
- $\text{C}_2\text{H}_2$  and  $\text{Cl}_2$
- $\text{NH}_3$  and HF
- $\text{CH}_4$  and  $\text{NH}_3$



**Answer:**

The correct option is **C**.

- To form a dative covalent bond one species must have a lone pair of electrons and the other must be electron deficient.
- $\text{NH}_3$  has a lone pair and HF splits into  $\text{H}^+$  (electron deficient) and  $\text{F}^-$

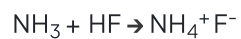

## 4.1.5 Bond Polarity

YOUR NOTES



### Bond Polarity

- When two atoms in a covalent bond have the **same electronegativity** the covalent bond is **nonpolar**

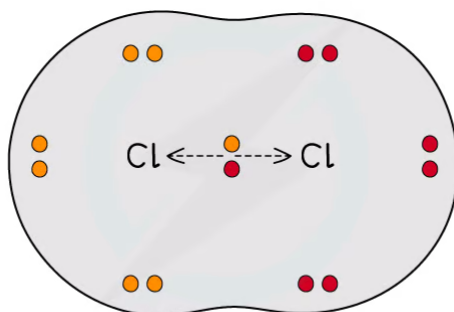

Copyright © Save My Exams. All Rights Reserved

*The two chlorine atoms have identical electronegativities so the bonding electrons are shared equally between the two atoms*

- When two atoms in a covalent bond have **different electronegativities** the covalent bond is **polar** and the electrons will be drawn towards the **more electronegative** atom
- As a result of this:
  - The negative charge centre and positive charge centre do not **coincide** with each other
  - This means that the **electron distribution** is **asymmetric**
  - The **less electronegative** atom gets a partial charge of  $\delta+$  (**delta positive**)
  - The **more electronegative** atom gets a partial charge of  $\delta-$  (**delta negative**)
- The greater the difference in **electronegativity** the more polar the bond becomes

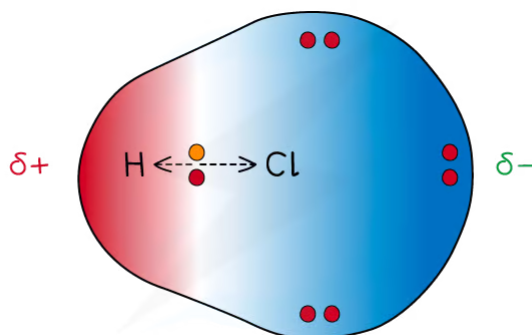

Copyright © Save My Exams. All Rights Reserved

*Cl has a greater electronegativity than H causing the electrons to be more attracted towards the Cl atom which becomes delta negative and the H delta positive*

### Dipole moment

- The **dipole moment** is a measure of how **polar** a bond is
- The **direction** of the dipole moment is shown by the following sign in which the **arrow** points to the **partially negatively charged end** of the dipole:



Copyright © Save My Exams. All Rights Reserved

The sign shows the direction of the dipole moment and the arrow points to the delta negative end of the dipole



### Worked Example

The electronegativity values of four elements are given.

$$\text{C} = 2.6 \quad \text{N} = 3.0 \quad \text{O} = 3.4 \quad \text{F} = 4.0$$

What is the order of **increasing** polarity of the **bonds** in the following compounds?

- A.  $\text{CO} < \text{OF}_2 < \text{NO} < \text{CF}_4$
- B.  $\text{NO} < \text{OF}_2 < \text{CO} < \text{CF}_4$
- C.  $\text{CF}_4 < \text{CO} < \text{OF}_2 < \text{NO}$
- D.  $\text{CF}_4 < \text{NO} < \text{OF}_2 < \text{CO}$

#### Answer:

The correct option is **B**.

- You have to calculate the difference in electronegativity for the bonds and then rank them from smallest to largest:

$$\text{NO} (3.4 - 3.0 = \mathbf{0.4})$$

$$\text{OF}_2 (4.0 - 3.4 = \mathbf{0.6})$$

$$\text{CO} (3.4 - 2.6 = \mathbf{0.8})$$

$$\text{CF}_4 (4.0 - 2.6 = \mathbf{1.4})$$

## 4.1.6 Lewis Structures

YOUR NOTES



## Lewis Structures

- **Lewis structures** are simplified electron shell diagrams and show pairs of electrons around atoms.
- A pair of electrons can be represented by dots, crosses, a combination of dots and crosses or by a line. For example, chlorine can be shown as:



*Different Lewis Structures for chlorine molecules*

- Note: Cl-Cl is not a **Lewis structure**, since it does not show all the electron pairs.
- The “**octet rule**” refers to the tendency of atoms to gain a valence shell with a total of 8 electrons

### Steps for drawing Lewis Structures

1. Count the total number of **valence**
2. Draw the **skeletal structure** to show how many atoms are linked to each other.
3. Use a pair of crosses or dot/cross to put an electron pair in each bond between the atoms.
4. Add more electron pairs to complete the octets around the atoms ( except H which has 2 electrons)
5. If there are not enough electrons to complete the octets, form double/triple bonds.
6. Check the total number of electrons in the finished structure is equal to the total number of **valence** electrons



### Worked Example

Draw a Lewis structure for CCl<sub>4</sub>

**Answer:**



1 TOTAL NUMBER OF VALENCE ELECTRONS =  $C + 4Cl = 4 + (4 \times 7) = 32$

2 DRAW THE SKELETAL POSITIONS

3 ADD THE BONDING PAIRS

ADD 24 LONE PAIR ELECTRONS

4 COMPLETED LEWIS STRUCTURE

4 BONDING PAIRS MEANS  $32 - 8 = 24$  ELECTRONS LEFT

LONE PAIRS

Copyright © Save My Exams. All Rights Reserved

**Steps in drawing the Lewis Structure for  $CCl_4$**

**Further examples of Lewis structures**

- Follow the steps for drawing Lewis structures for these common molecules

Molecule	Total number of valence electrons	Lewis structure
$CH_4$	$C + 4H$ $4 + (4 \times 1) = 8$	$\begin{array}{c} H \\   \\ H:C:H \\   \\ H \end{array}$
$NH_3$	$N + 3H$ $5 + (3 \times 1) = 8$	$\begin{array}{c} H:\ddot{N}:H \\   \\ H \end{array}$
$H_2O$	$2H + O$ $(2 \times 1) + 6 = 8$	$H:\ddot{O}:H$
$CO_2$	$C + 2O$ $4 + (2 \times 6) = 16$	$:\ddot{O}:C:\ddot{O}:$
$HCN$	$H + C + N$ $1 + 4 + 5 = 10$	$H:C\equiv N:$

Copyright © Save My Exams. All Rights Reserved

## Incomplete Octets

- For elements below atomic number 20 the **octet rule** states that the atoms try to achieve 8 electrons in their valence shells, so they have the same electron configuration as a noble gas
- However, there are some elements that are exceptions to the **octet rule**, such as H, Li, Be, B and Al
  - H can achieve a stable arrangement by gaining an electron to become  $1s^2$ , the same structure as the noble gas helium
  - Li does the same, but losing an electron and going from  $1s^2 2s^1$  to  $1s^2$  to become a  $Li^+$  ion
  - Be from group 2, has two valence electrons and forms stable compounds with just four electrons in the valence shell
  - B and Al in group 13 have 3 valence electrons and can form stable compounds with only 6 valence electrons
- There are two examples of **Lewis structures** with incomplete octets you should know,  $BeCl_2$  and  $BF_3$ :

### Incomplete Octets Examples

Molecule	Total number of valence electrons	Lewis structure
$BeCl_2$	$Be + 2Cl =$ $2 + (2 \times 7) = 16$	$:\ddot{Cl}:Be:\ddot{Cl}:$
$BF_3$	$B + 3F =$ $3 + (3 \times 7) = 24$	$:\ddot{F}:B:\ddot{F}:$ $:\ddot{F}:$

Copyright © Save My Exams. All Rights Reserved

- Test your understanding of Lewis diagrams in the following example:

YOUR NOTES





### Worked Example

How many electrons are in the 2-aminoethanoic acid molecule?

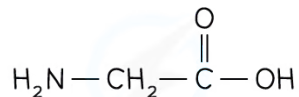

2-AMINOETHANOIC ACID

Copyright © Save My Exams. All Rights Reserved

- A. 18
- B. 20
- C. 28
- D. 30

YOUR NOTES



### Answer:

The correct option is **D**.

- You must count the lone pairs on N and O as well as the bonding pairs. There are 5 'hidden' pairs of bonding electrons in the OH, CH<sub>2</sub> and NH<sub>2</sub> groups. Hydrogen does not follow the octet rule.



## 4.2 Resonance, Shapes & Giant Structures

### 4.2.1 Resonance Structures

#### Resonance Structures

- The delocalization of electrons can explain the structures of some species that don't seem to fit with a Lewis structure
- Delocalized electrons are electrons in a molecule, ion or solid metal that are not associated with a single atom or one covalent bond
- The Lewis diagram for the nitrate ( $\text{V}$ ) ion gives a molecule with a double and two single bonds
- There are three possible Lewis Structures
- These structures are called resonance structures
- However, studies of the electron density and bond length in the nitrate ( $\text{V}$ ) ion indicate all the bonds are equal in length and the electron density is spread evenly between the three oxygen atoms
  - The bond length is intermediate between a single and a double bond
  - The actual structure is something in between the resonance structures and is known as a resonance hybrid

#### Resonance structures of the nitrate ( $\text{V}$ ) ion

- To determine the Lewis structure of the nitrate ( $\text{V}$ ) ion first count the number of valence electrons and then add one electron for the negative charge on the ion

$$\text{Number of valence electrons} = \text{N} + 3\text{O} + 1$$

$$= 5 + (3 \times 6) + 1 = \mathbf{24 \text{ electrons}}$$

- Three structures are possible, consisting of a double bond and two singles:

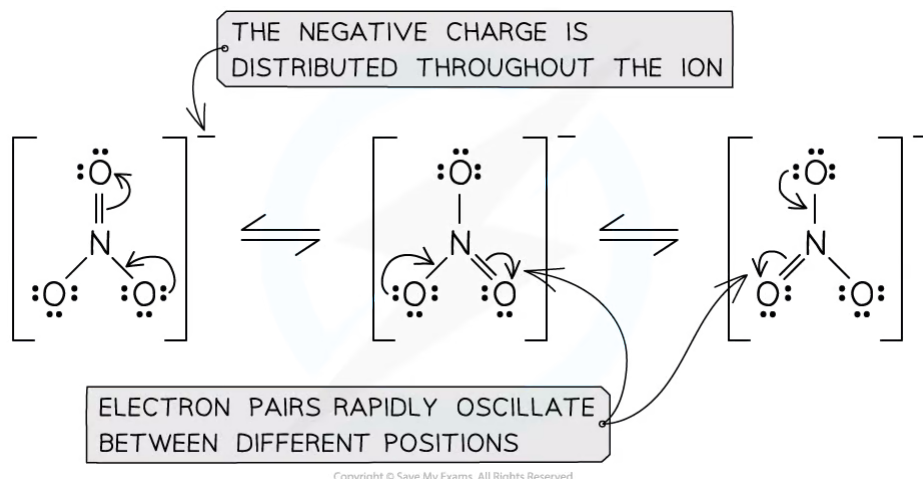

#### Resonance structures in the nitrate ion

- Dotted lines are used to show the position of the delocalised electrons



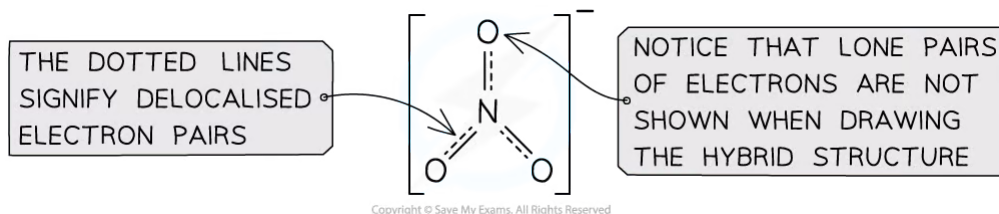

### Resonance hybrid nitrate (V) ion

- The criteria for forming resonance hybrids structures is that molecules must have a double bond (pi bond) that is capable of migrating from one part of a molecule to another
- This usually arises when there are adjacent atoms with equal electronegativity and lone pairs of electrons that can re-arrange themselves and allow the double bonds to be in different positions
- Other examples that you should know about are the carbonate ion, benzene, ozone and the carboxylate anion

### Resonance Hybrids Table

- Below are some other resonance structures and hybrids that you should know:

Species	Lewis resonance structures	Resonance hybrid
Carbonate ion, $\text{CO}_3^{2-}$		
Benzene, $\text{C}_6\text{H}_6$		
Ozone, $\text{O}_3$		
Carboxylate ion, $\text{RCOO}^-$		

Copyright © Save My Exams. All Rights Reserved

YOUR NOTES



## 4.2.2 Shapes of Molecules

YOUR NOTES



## Shapes of Molecules

- When an atom forms a covalent bond with another atom, the electrons in the different bonds and the non-bonding electrons in the outer shell all behave as negatively charged clouds and repel each other
- In order to minimise this repulsion, all the outer shell electrons spread out as far apart in space as possible
- Molecular shapes and the angles between bonds can be predicted by the **valence shell electron pair repulsion theory** known by the abbreviation **VSEPR** theory
- VSEPR** theory consists of three basic rules:
  - All electron pairs and all lone pairs arrange themselves as far apart in space as is possible.**
  - Lone pairs repel more strongly than bonding pairs.**
  - Multiple bonds behave like single bonds**
- These three rules can be used to predict the shape of any covalent molecule or ion, and the angles between the bonds
- The regions of negative cloud charge are known as **domains** and can have one, two or three pairs electrons

### Two electron domains

- If there are two electron domains on the central atom, the angle between the bonds is  $180^\circ$
- Molecules which adopt this shape are said to be **LINEAR**
- Examples of linear molecules include  $\text{BeCl}_2$ ,  $\text{CO}_2$ , and  $\text{HC}\equiv\text{CH}$

 LEWIS  
STRUCTURES

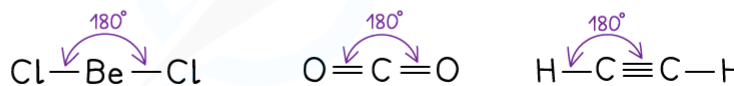
 MOLECULAR  
SHAPES

Copyright © Save My Exams. All Rights Reserved

### Two electron domain molecules

### Three electron domains

- If there are three electron domains on the central atom, the angle between the bonds is  $120^\circ$
- Molecules which adopt this shape are said to be **TRIANGULAR PLANAR** or **TRIGONAL PLANAR**
- Examples of three electrons domains which are all bonding pairs include  $\text{BF}_3$  and  $\text{CH}_2\text{CH}_2$  and  $\text{CH}_2\text{O}$



LEWIS STRUCTURES

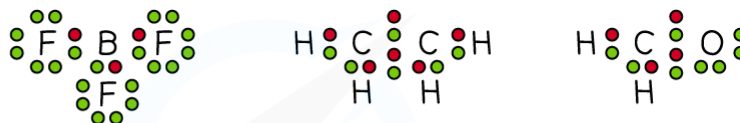

MOLECULAR SHAPES

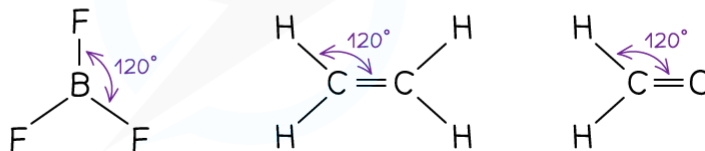

Copyright © Save My Exams. All Rights Reserved

### Molecules with three electron domains

- If one of these electron domains is a lone pair, the bond angle is slightly less than  $120^\circ$  due to the stronger repulsion from lone pairs, forcing the bonding pairs closer together. E.g.  $\text{SO}_2$
- The bond angle is approximately  $= 118^\circ$



LEWIS STRUCTURE

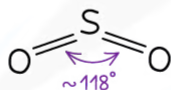

MOLECULAR SHAPE

Copyright © Save My Exams. All Rights Reserved

### The shape of sulfur dioxide

- Sulfur dioxide is an example of a molecule that '**expands the octet**' as you will see there are 10 electrons around the sulfur atom which is possible for 3rd period elements and above
- This shape is no longer called trigonal planar as the shape names are only based on the atoms present, this molecule is **BENT LINEAR**

### Four electron domains

- If there are four electron domains on the central atom, the angle between the bonds is approx  $109^\circ$ . E.g.  $\text{CH}_4$ ,  $\text{NH}_4^+$
- Molecules which adopt this shape are said to be **TETRAHEDRAL**

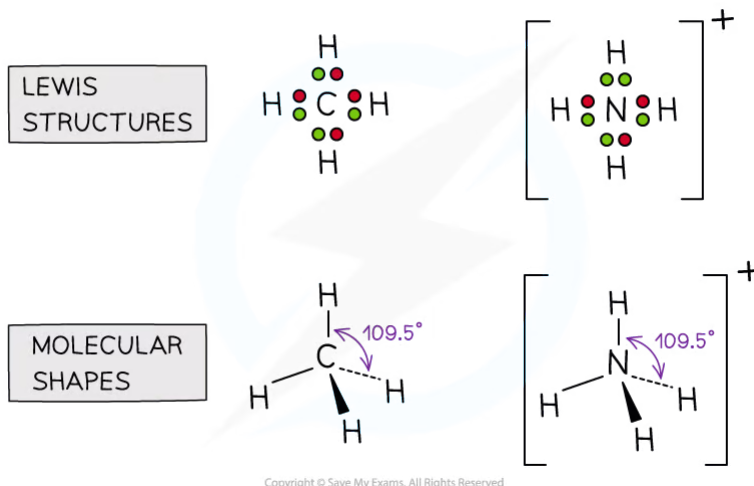

### Molecules with four electron domains

- If one of the electron domains is a lone pair, the bond angle is slightly less than  $109^\circ$ , due to the extra lone pair repulsion which pushes the bonds closer together (approx  $107^\circ$ ). E.g.  $\text{NH}_3$ ,

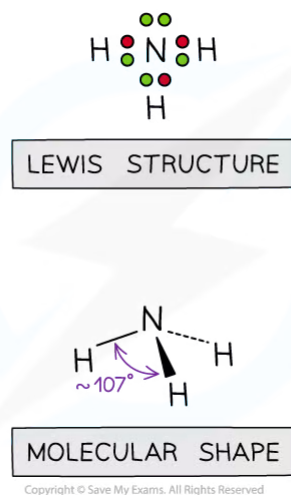

### The shape of ammonia

- Molecules which adopt this shape are said to be **TRIANGULAR PYRAMIDAL** or **TRIGONAL PYRAMIDAL**
- If two of the electron domains are lone pairs, the bond angle is also slightly less than  $109^\circ$ , due to the extra lone pair repulsion (approx  $104^\circ$ ). E.g.  $\text{H}_2\text{O}$
- Molecules which adopt this shape are said to be **BENT** or **ANGULAR** or **BENT LINEAR** or **V-shaped** (when viewed upside down)

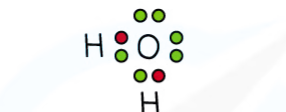

LEWIS STRUCTURE

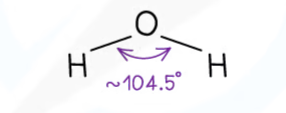

MOLECULAR SHAPE

Copyright © Save My Exams. All Rights Reserved

**The shape of water**

- Lone pairs are pulled more closely to the central atoms so they exert a greater repulsive force than bonding pairs

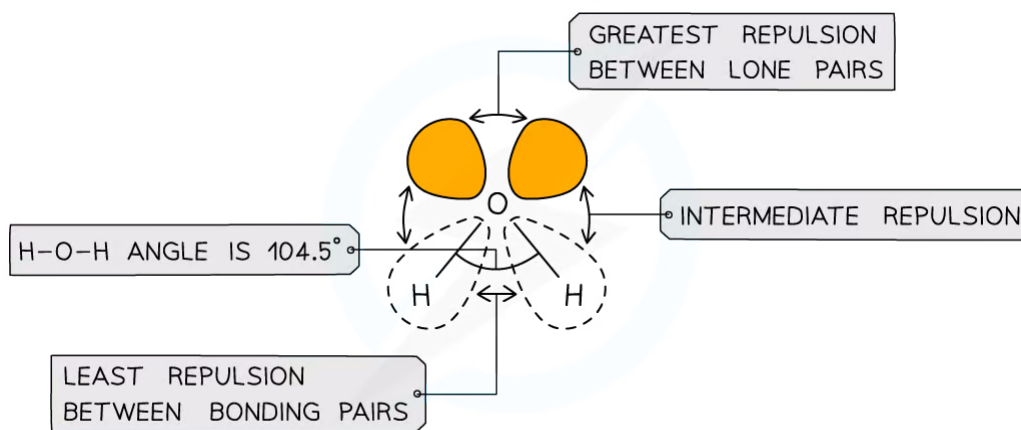

Copyright © Save My Exams. All Rights Reserved

**Different types of electron pairs have different repulsive forces**

**Summary table of electron domains and molecular shapes**

- These are the domains and molecular geometries you need to know for Standard Level:

Bonding pairs	Lone pairs	Total pairs	Domain geometry	Molecular geometry	Bond angle
2	0	2	linear	linear	$180^\circ$
3	0	3	trigonal planar	trigonal planar	$120^\circ$
2	1	3	trigonal planar	bent linear	$118^\circ$
4	0	4	tetrahedral	tetrahedral	$109.5^\circ$
3	1	4	tetrahedral	trigonal pyramid	$107^\circ$
2	2	4	tetrahedral	bent linear	$104.5^\circ$

Copyright © Save My Exams. All Rights Reserved

YOUR NOTES



### Exam Tip

Be careful to distinguish between molecular shape and electron domain shape as it can be easy to confuse the two. Sometimes they are the same as is the case of methane, but other times they can be different like ammonia which has a tetrahedral domain shape, but triangular pyramid molecular shape. Always draw the Lewis structure before you attempt to deduce the shape and bond angle as you could easily miss some lone pairs

## 4.2.3 Predicting Molecular Shapes

### Predicting Shapes & Bond Angles

- Before you predict the shape of any molecule work out the Lewis structure to determine the number of bonding and lone pairs
- Apply the VSEPR rules and you should be successful in deducing the correct shape and bond angle

#### ? Worked Example

Predict the domain geometry, shape and bond angle in the following molecules or ions:

1.  $\text{H}_2\text{S}$
2.  $\text{NH}_2\text{Cl}$
3.  $\text{NO}_2^+$
4.  $\text{ClF}_2^+$

#### Answers:

**Answer 1:** The total number of valence electrons in  $\text{H}_2\text{S}$  is  $= 1 + 1 + 6 = 8$ , so there are four pairs of electrons around S

Hydrogen only forms one bond, so there are two bonding pairs and two lone pairs:

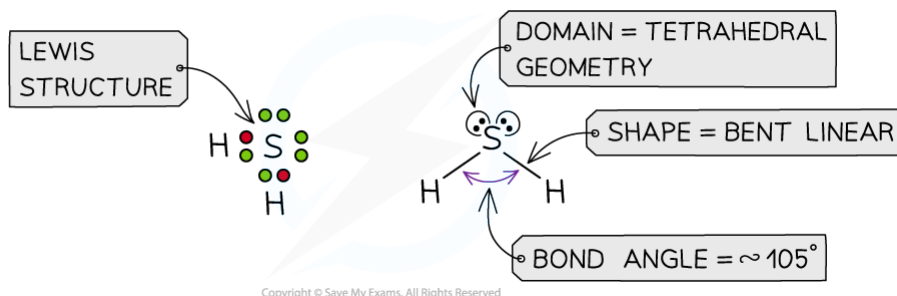

**Answer 2:** The total number of valence electrons in  $\text{NH}_2\text{Cl}$  is  $= 5 + 1 + 1 + 7 = 14$

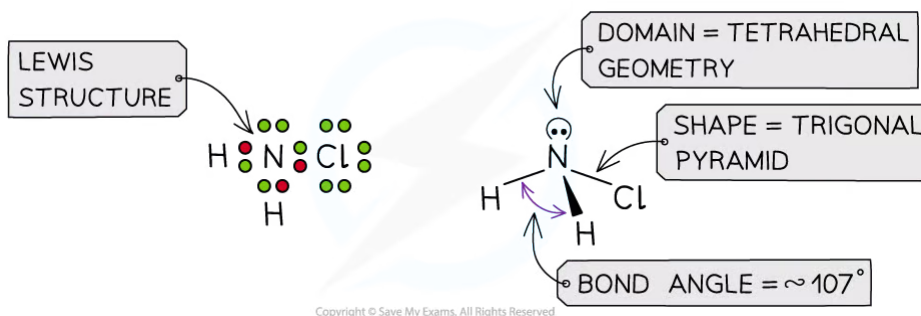

**Answer 3:** The total number of valence electrons in  $\text{NO}_2^+$  is  $= 5 + 6 + 6 - 1 = 16$  (subtracting one for the positive charge)

YOUR NOTES



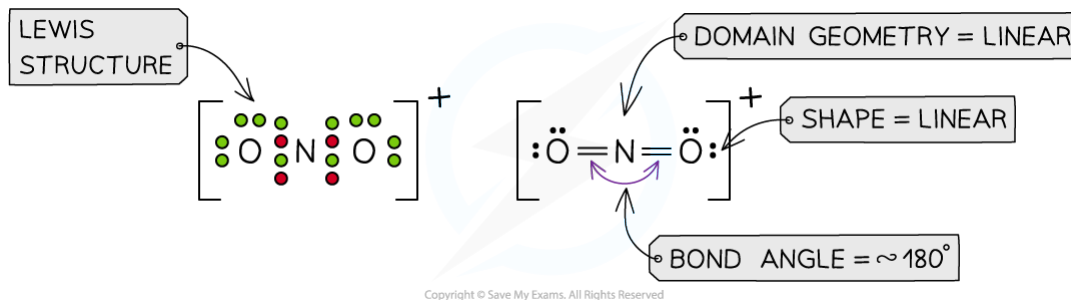

YOUR NOTES



**Answer 4:** The total number of valence electrons in  $\text{ClF}_2^+$  =  $7 + 7 + 7 - 1 = 20$  (subtracting one for the positive charge)

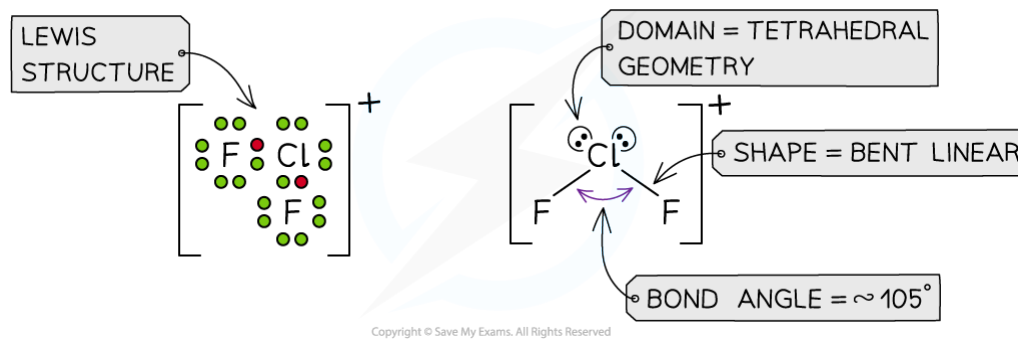

### Exam Tip

For Standard Level Chemistry you are only required to know the shape of molecules up to four electron domains.



4.2.4 Molecular Polarity

YOUR NOTES



Molecular Polarity

Assigning polarity to molecules

- There is a difference between **bond polarity** and **molecular polarity**
- To determine whether a molecule is polar, the following things have to be taken into consideration:
  - The polarity of each bond
  - How the bonds are arranged in the molecule
- Some molecules have **polar bonds** but are overall not **polar** because the polar bonds in the molecule are arranged in such way that the individual dipole moments **cancel each other out**

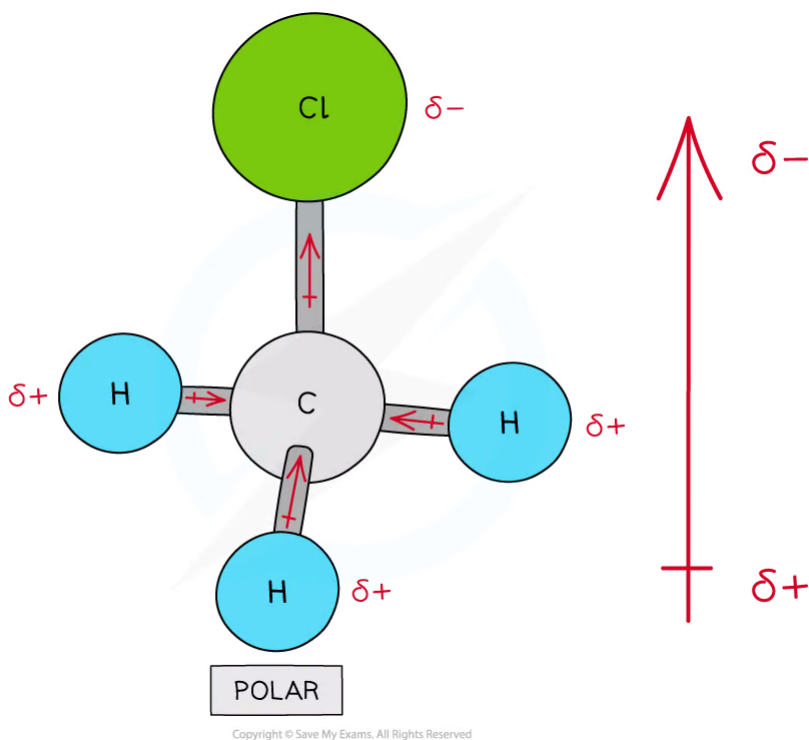

***There are four polar covalent bonds in  $\text{CH}_3\text{Cl}$  which do not cancel each other out causing  $\text{CH}_3\text{Cl}$  to be a polar molecule; the overall dipole is towards the electronegative chlorine atom***

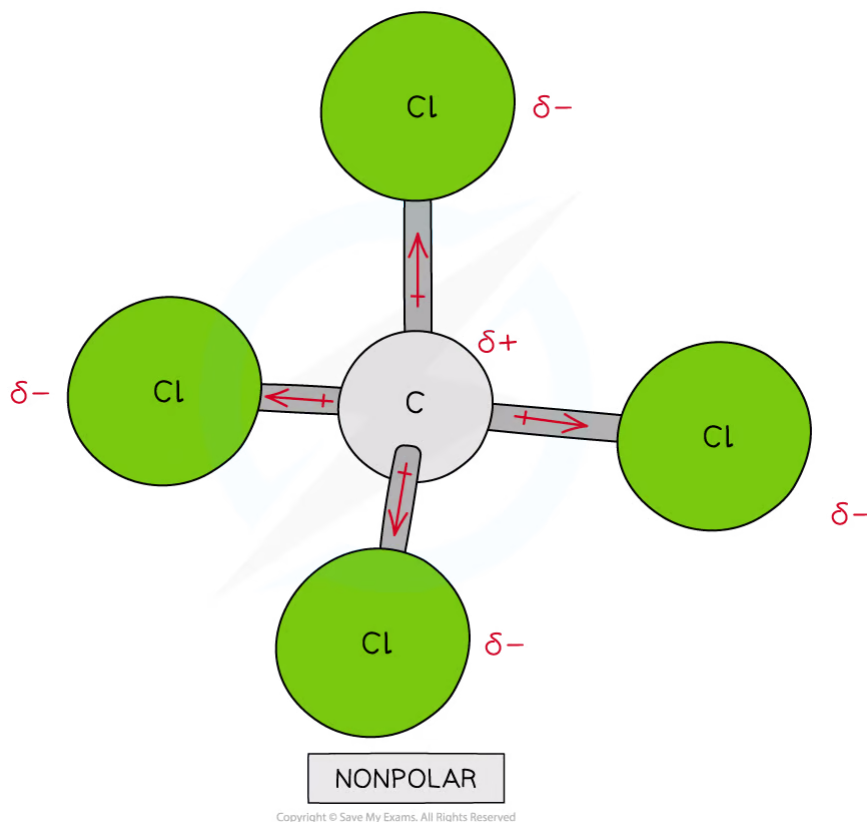

**Though  $\text{CCl}_4$  has four polar covalent bonds, the individual dipole moments cancel each other out causing  $\text{CCl}_4$  to be a nonpolar molecule**

- Further examples of molecules with no net dipole:

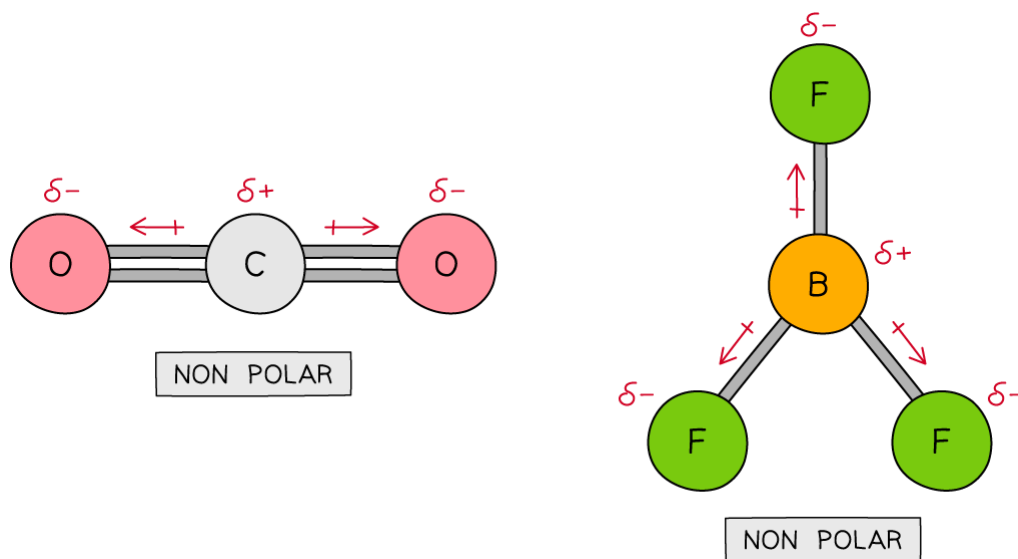

**Carbon dioxide and boron trifluoride have polar bonds but no net dipole**

- Try your hand at this polarity question:



### Worked Example

Which molecule is non-polar?

- A.  $\text{NH}_3$
- B.  $\text{CO}$
- C.  $\text{SO}_2$
- D.  $\text{AlBr}_3$

YOUR NOTES



#### Answer:

The correct option is **D**.

- The shapes and polarity of the molecules are as follows:

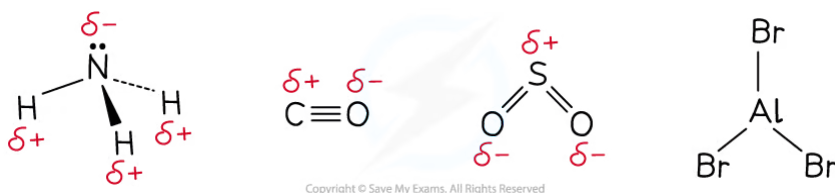

Although the Al-Br bonds are polar, the trigonal planar molecule is symmetrical so the dipoles cancel out leaving a non-polar molecule



#### Exam Tip

One of the clues about molecular polarity is to look at the symmetry of the molecule

Molecules which are symmetrical are unlikely to be polar

## 4.2.5 Giant Covalent Structures

YOUR NOTES



### Giant Covalent Structures

#### Covalent lattices

- **Covalent bonds** are bonds between nonmetals in which electrons are **shared** between the atoms
- In some cases, it is not possible to satisfy the bonding capacity of a substance in the form of a molecule; the bonds between atoms continue indefinitely, and a large lattice is formed. There are no individual molecules and covalent bonding exists between all adjacent atoms
- Such substances are called **giant covalent substances**, and the most important examples are C and SiO<sub>2</sub>
- Graphite, diamond, buckminsterfullerene and graphene are allotropes of carbon

#### Diamond

- Diamond is a giant lattice of carbon atoms
- Each carbon is covalently bonded to four others in a tetrahedral arrangement with a bond angle of 109.5°
- The result is a giant lattice with strong bonds in all directions
- Diamond is the hardest substance known
  - For this reason it is used in drills and glass-cutting tools

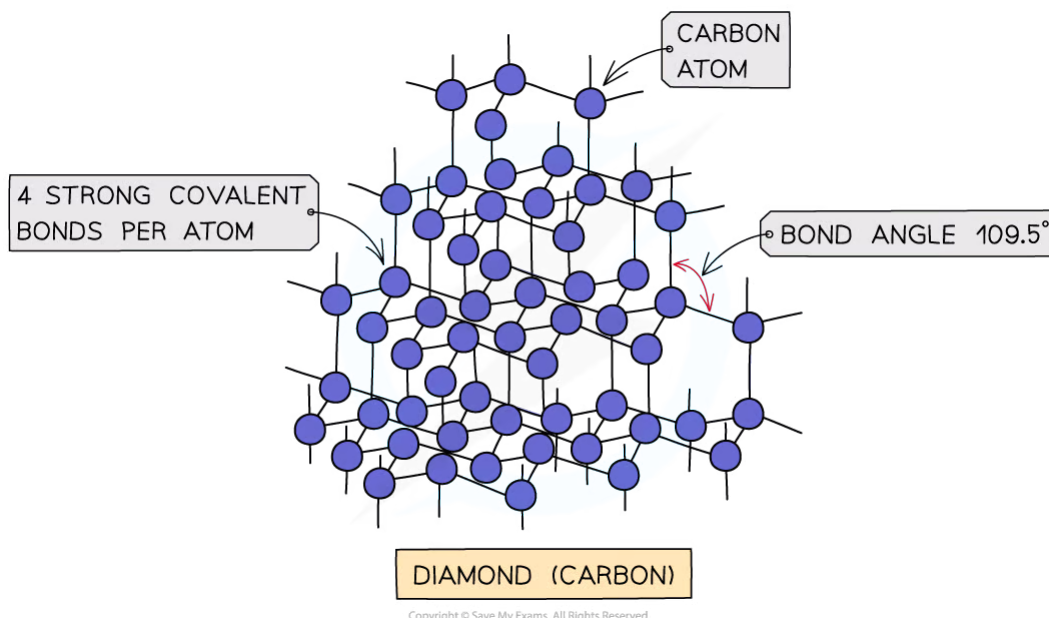

**The structure of diamond**

#### Graphite

- In graphite, each carbon atom is bonded to three others in a layered structure
- The layers are made of hexagons with a bond angle of 120°
- The spare electron is delocalised and occupies the space in between the layers

- All atoms in the same layer are held together by strong covalent bonds, and the different layers are held together by weak intermolecular forces

YOUR NOTES

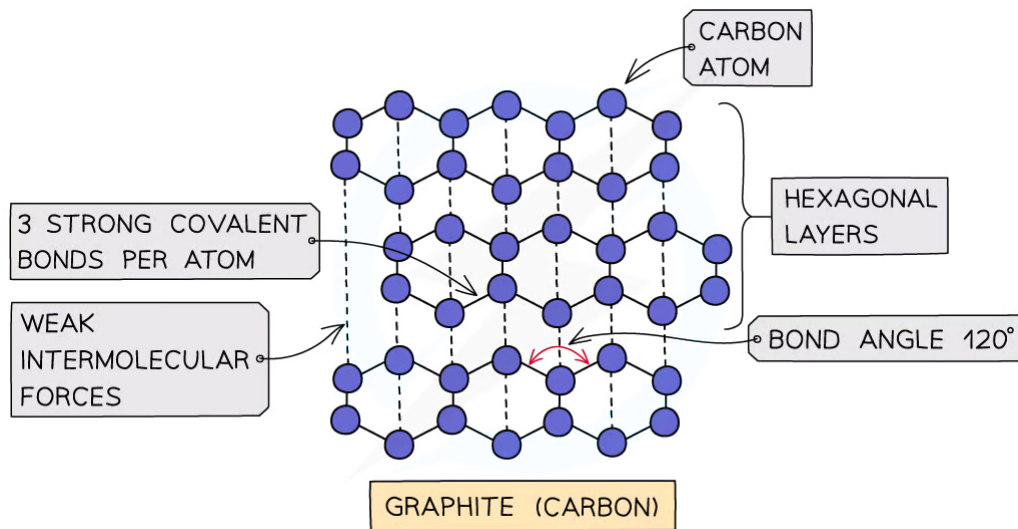

Copyright © Save My Exams. All Rights Reserved

**The structure of graphite**

**Buckminsterfullerene**

- **Buckminsterfullerene** is one type of fullerene, named after Buckminster Fuller, the American architect who designed domes like the Epcot Centre in Florida
- It contains 60 carbon atoms, each of which is bonded to three others by single covalent bonds
- The fourth electron is delocalised so the electrons can migrate throughout the structure making the buckyball a semi-conductor
- It has exactly the same shape as a soccer ball, hence the nickname the football molecule

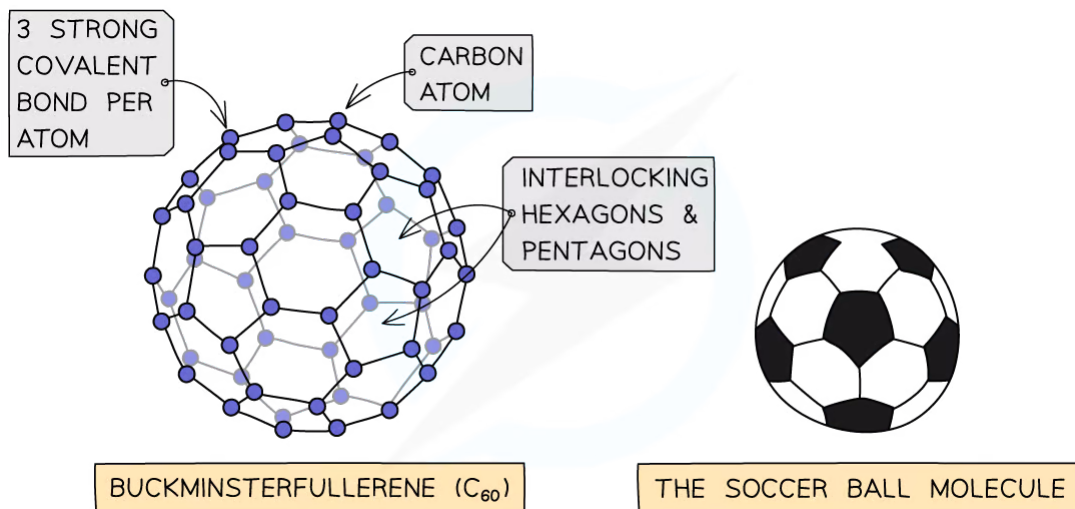

Copyright © Save My Exams. All Rights Reserved

**The structure of buckminsterfullerene**

**Graphene**

- Some substances contain an infinite lattice of covalently bonded atoms in two dimensions only to form layers. Graphene is an example
- Graphene is made of a single layer of carbon atoms that are bonded together in a repeating pattern of hexagons
- Graphene is one million times thinner than paper; so thin that it is actually considered two dimensional

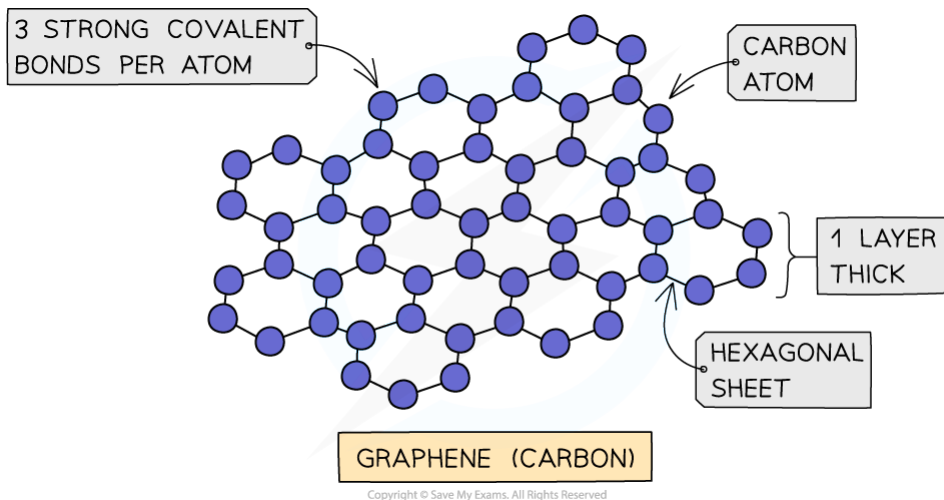

**The structure of graphene**

## Silicon(IV)oxide

- Silicon(IV)oxide is also known as silicon dioxide, but you will be more familiar with it as the white stuff on beaches!
- Silicon(IV)oxide adopts the same structure as diamond - a giant structure made of tetrahedral units all bonded by strong covalent bonds
- Each silicon is shared by four oxygens and each oxygen is shared by two silicons
- This gives an empirical formula of  $\text{SiO}_2$

YOUR NOTES



YOUR NOTES

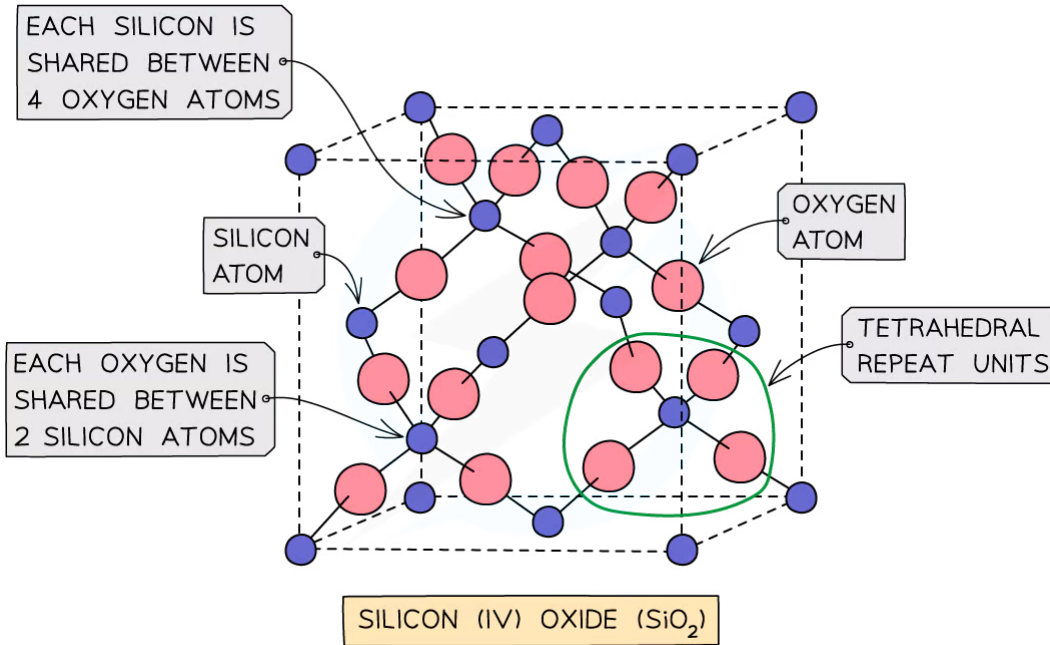

Copyright © Save My Exams. All Rights Reserved

**The structure of silicon dioxide**

## Properties of Giant Structures

- Different types of **structure** and **bonding** have different effects on the **physical properties** of substances such as their **melting** and **boiling points**, **electrical conductivity** and **solubility**

### Covalent bonding & giant covalent lattice structures

- **Giant covalent lattices** have very high **melting** and **boiling points**
  - These compounds have a large number of **covalent bonds** linking the whole structure
  - A lot of energy is required to break the lattice
- The compounds can be **hard** or **soft**
  - Graphite is **soft** as the forces between the carbon layers are weak
  - Diamond and silicon(IV) oxide are **hard** as it is difficult to break their 3D network of strong covalent bonds
  - Graphene is strong, flexible and transparent which it makes it potentially a very useful material
- Most compounds are insoluble with water
- Most compounds do not **conduct electricity** however some do
  - Graphite has **delocalised** electrons between the carbon layers which can move along the layers when a voltage is applied
  - Graphene is an excellent conductor of electricity due to the **delocalised** electrons
  - Buckminsterfullerene is a semi-conductor
  - Diamond and silicon(IV) oxide do not conduct electricity as all four outer electrons on every carbon atom is involved in a **covalent bond** so there are no free electrons available

Characteristics of Giant Covalent Structures Table

	Diamond	Graphite	Buckminster-fullerene	Graphene	Silicon dioxide
<b>Melting and boiling point</b>	Very high	Very high	Low	Very high	Very high
<b>Electrical Conductivity</b>	Non-conductor	Good	Semi-conductor	Very good conductor	Non-conductor
<b>Appearance</b>	Transparent crystals	Grey-black solid	Yellow solid	Transparent sheets	Transparent crystals
<b>Special Characteristics</b>	Hardest known naturally occurring substance	Soft and slippery	Very light and strong	Very strong and flexible: 100 times stronger than steel	Piezoelectric – produces electric charge from mechanical stress

Copyright © Save My Exams. All Rights Reserved

YOUR NOTES







### Exam Tip

Although buckminsterfullerene is included in this section it is not classified as a giant structure as it has a fixed formula,  $C_{60}$

YOUR NOTES



## 4.3 Intermolecular Forces & Metallic Bonding

### 4.3.1 Types of Intermolecular Forces

#### Intermolecular Forces

- There are no covalent bonds between molecules in molecular covalent compounds. There are, however, forces of attraction between these molecules, and it is these which must be overcome when the substance is melted and boiled
- These forces are known as **intermolecular forces**
- There are three main types of **intermolecular forces**:
  - London (dispersion) forces
  - Dipole-dipole attraction
  - Hydrogen bonding

#### London (dispersion) forces

- The electrons in atoms are not static; they are in a state of constant motion
  - It is therefore likely that at any given time the distribution of electrons will not be exactly symmetrical - there is likely to be a slight surplus of electrons on one side of the atoms

YOUR NOTES



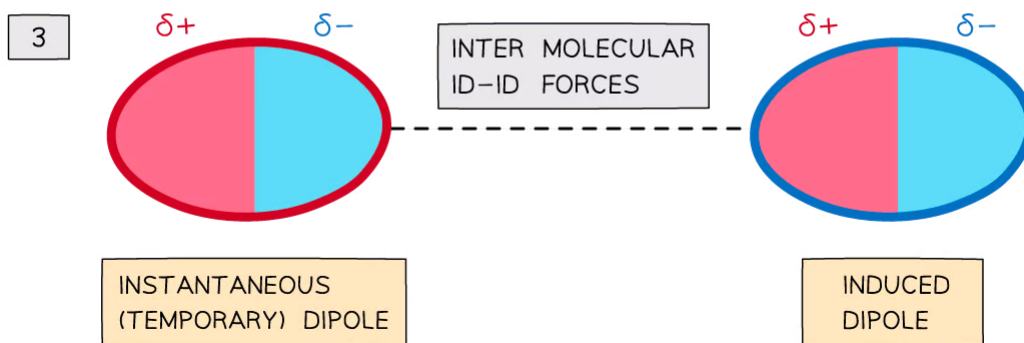
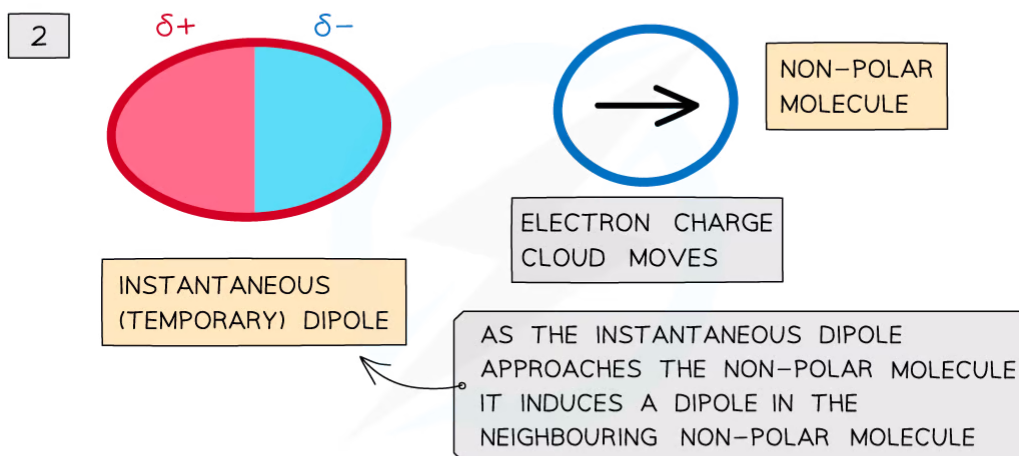
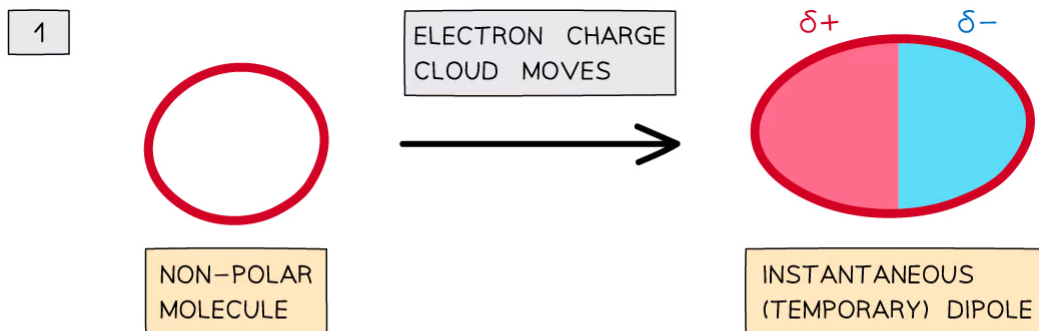

Copyright © Save My Exams. All Rights Reserved

### London (Dispersion) forces

- This is known as a **temporary dipole**
  - It lasts for a very short time as the electrons are constantly moving
  - **Temporary dipoles** are constantly appearing and disappearing
- Consider now an adjacent atom. The electrons on this atom are repelled by the negative part of the dipole and attracted to the positive part and move accordingly
- This is a **temporary induced dipole**
  - There is a resulting attraction between the two atoms, and this known as **London (dispersion) forces**, after the German chemist, Fritz London



- **London (dispersion) forces** are present between all atoms and molecules, although they can be very weak
  - They are the reason all compounds can be liquefied and solidified
  - **London (dispersion) forces** tend to have strengths between  $1 \text{ kJ mol}^{-1}$  and  $50 \text{ kJ mol}^{-1}$ .
- The strength of the **London (dispersion) forces** in between molecules depends on two factors:
  - the number of electrons in the molecule
  - Surface area of the molecules

### Number of electrons

- The greater the number of electrons in a molecule, the greater the likelihood of a distortion and thus the greater the frequency and magnitude of the temporary dipoles
- The dispersion forces between the molecules are stronger and the melting and boiling points are larger
- The [popover id="TijjiYH5LAecLpp" label="enthalpies of vaporisation"] and boiling points of the noble gases illustrate this factor:

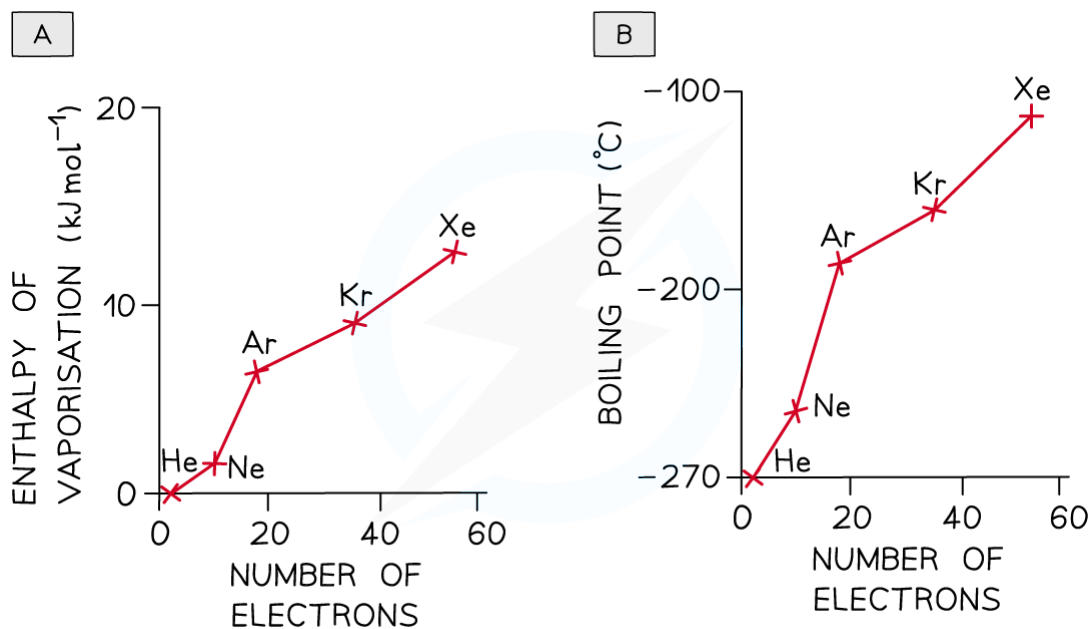

**As the number of electrons increases more energy is needed to overcome the forces of attraction between the noble gases atoms**

### Surface area

- The larger the surface area of a molecule, the more contact it will have with adjacent molecules
- The greater its ability to induce a dipole in an adjacent molecule, the greater the **London (dispersion) forces** and the higher the melting and boiling points
- This point can be illustrated by comparing different isomers containing the same number of electrons:

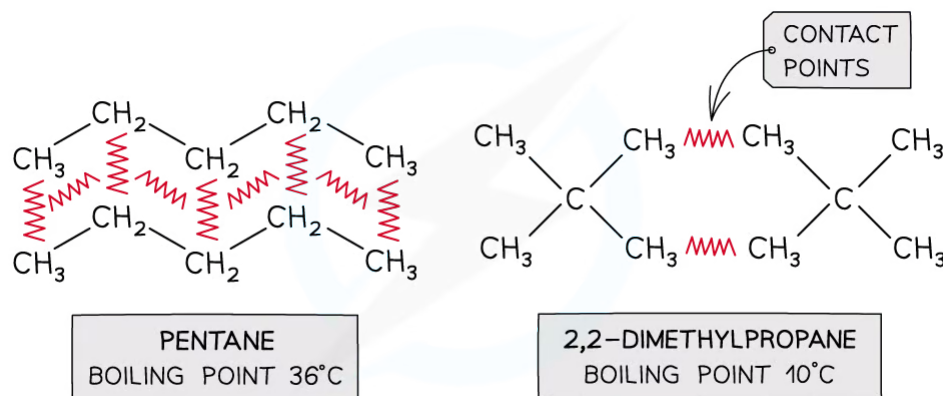

Copyright © Save My Exams. All Rights Reserved

**Boiling points of molecules with the same numbers of electrons but different surface areas**

**Dipole-dipole attractions**

- Temporary dipoles exist in all molecules, but in some molecules there is also a **permanent dipole**
- In addition to the **London (dispersion) forces** caused by temporary dipoles, molecules with permanent dipoles are also attracted to each other by **permanent dipole-dipole bonding**

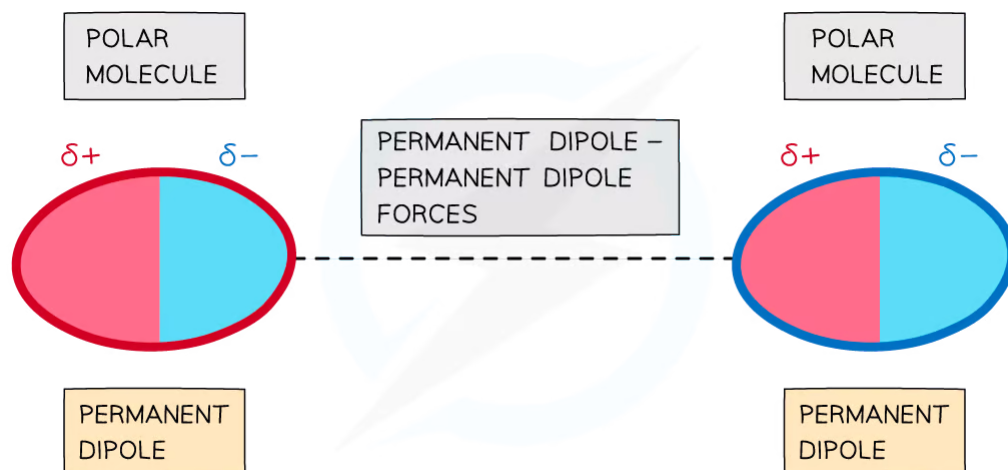

Copyright © Save My Exams. All Rights Reserved

**The delta negative end of one polar molecule will be attracted onwards the delta positive end of a neighbouring polar molecule**

- This is an attraction between a **permanent dipole** on one molecule and a **permanent dipole** on another.
- **Dipole-dipole bonding** usually results in the boiling points of the compounds being slightly higher than expected from temporary dipoles alone
  - it slightly increases the strength of the intermolecular attractions
- The effect of **dipole-dipole bonding** can be seen by comparing the melting and boiling points of different substances which should have **London(dispersion) forces** of similar



strength

### Comparing butane and propanone

- For small molecules with **the same number of electrons**, **dipole-dipole attractions** are **stronger** than **dispersion forces**
  - Butane and propanone have the same number of electrons
  - Butane is a nonpolar molecule and will have only dispersion forces
  - Propanone is a polar molecule and will have dipole-dipole attractions and dispersion forces
  - Therefore, more energy is required to break the intermolecular forces between propanone molecules than between butane molecules
  - The result is that propanone has a higher boiling point than butane

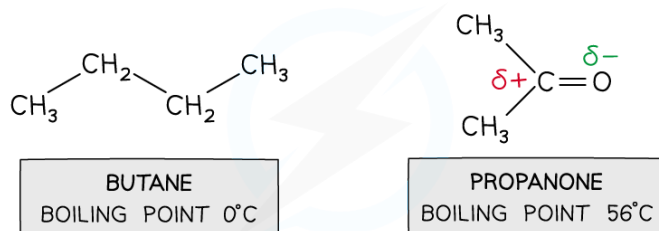

Copyright © Save My Exams. All Rights Reserved

### Comparing substances with permanent and temporary dipoles in smaller molecules with an equal number of electrons

## Hydrogen bonding

- Hydrogen bonding** is the **strongest** type of **intermolecular force**
  - Hydrogen bonding is a special type of **permanent dipole – permanent dipole** bonding
- For hydrogen bonding to take place the following is needed:
  - A species which has an **O** or **N** or **F** (very **electronegative**) atom with an available **lone pair** of electrons
  - A hydrogen attached to the **O, N** or **F**
- When hydrogen is covalently bonded to an **electronegative** atom, such as **O** or **N**, the bond becomes very highly **polarised**
- The H becomes so  $\delta^+$  charged that it can form a bond with the **lone pair** of an **O** or **N** atom in another molecule

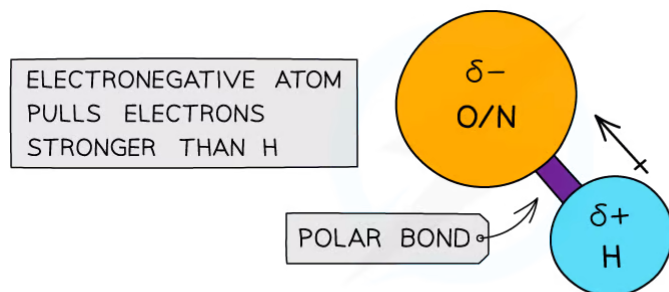

Copyright © Save My Exams. All Rights Reserved



**The electronegative atoms O or N have a stronger pull on the electrons in the covalent bond with hydrogen, causing the bond to become polarised**

- Hydrogen bonds are represented by dots or dashes between H and the N/O/F element
- The number of hydrogen bonds depends on:
  - The number of hydrogen atoms attached to O or N in the molecule
  - The number of **lone pairs** on the O or N

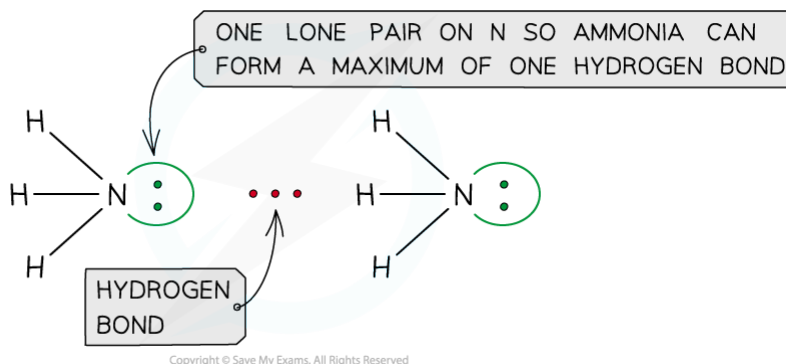

**Ammonia can form a maximum of one hydrogen bond per molecule**

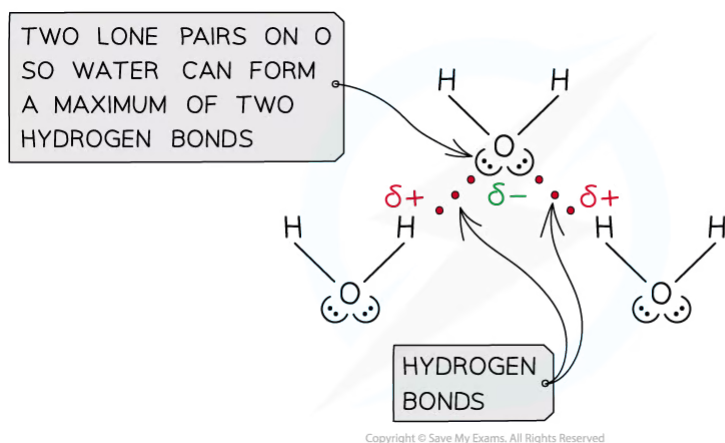

**Water can form a maximum of two hydrogen bonds per molecule**

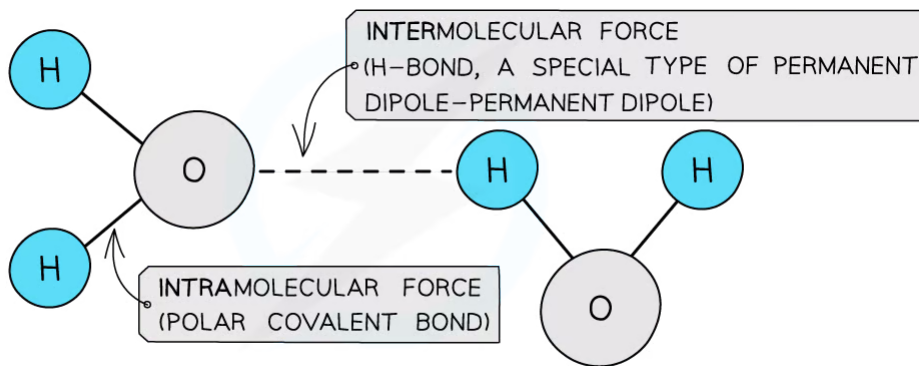

Copyright © Save My Exams. All Rights Reserved

***The polar covalent bonds between O and H atoms are intramolecular forces and the permanent dipole – permanent dipole forces between the molecules are intermolecular forces as they are a type of van der Waals' force***



### Exam Tip

The term "London (dispersion) forces" refers to instantaneous induced dipole induced dipole forces that exist between any atoms or groups of atoms and should be used for non-polar species. You may be wondering about the term "van der Waals" forces: it is an inclusive term and refers to dipole-dipole, dipole-induced dipole and London (dispersion) forces

YOUR NOTES





### 4.3.2 Deducing Intermolecular Forces

#### Deducing Intermolecular Forces

- In order to deduce the types of **intermolecular forces** present in molecules you need information about the structure and chemical formula of the molecules
- The chemical formula will tell you about the presence of electronegative elements present in the molecule
  - Any potential polar bonds can be identified
  - If N, O or F is present then hydrogen bonds are potentially possible
- The structure and symmetry of the molecule will enable you to determine if the molecule is polar following the principles laid out in **4.1.10 Molecular Polarity**

#### ? Worked Example

Which of the compounds below can form intermolecular hydrogen bonds in the liquid state?

- A.  $(\text{CH}_3\text{CH}_2)_3\text{N}$
- B.  $\text{CH}_3\text{OCH}_3$
- C.  $\text{CCl}_4$
- D.  $\text{C}_2\text{H}_5\text{OH}$

#### Answer:

The correct option is **D**.

- Draw the displayed structures of the molecules:

YOUR NOTES



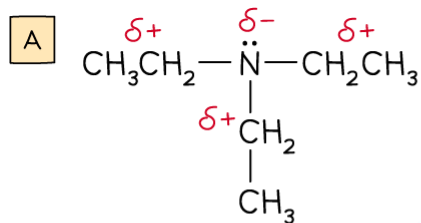

POLAR BONDS  
ASYMMETRICAL  
POLAR MOLECULE

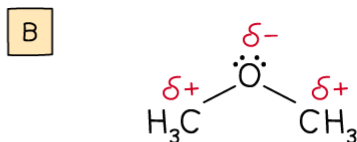

POLAR BONDS  
ASYMMETRICAL  
POLAR MOLECULE

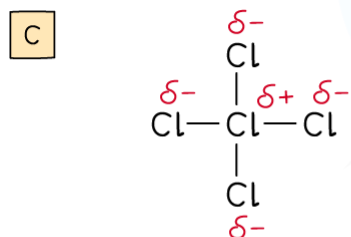

POLAR BONDS SYMMETRICAL  
NON-POLAR MOLECULE

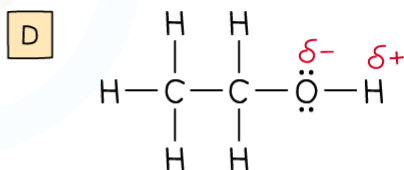

POLAR BONDS ASYMMETRICAL  
POLAR MOLECULE H ATTACHED  
TO NOF ELEMENT

Copyright © Save My Exams. All Rights Reserved

- Molecules **A** and **B** form dipole-dipole attractions as they are polar molecules
- Molecule **C** forms dispersion forces as the dipoles cancel out so there is no overall polarity
- Molecule **D** is the only one capable of forming hydrogen bonds



### Exam Tip

Sometimes a question will ask you to name all the IMFs present in molecules and students frequently forget to include dispersion forces which are present in all molecules, since everything contains electrons!

YOUR NOTES



### 4.3.3 Properties of Covalent Compounds

## Properties of Covalent Compounds

- The physical properties of **molecular covalent compounds** are largely influenced by their **intermolecular forces**
- If you know the type of **intermolecular forces** present you can predict the physical properties like **melting** and **boiling point**, **solubility**, and **conductivity**

### Melting and boiling point

- When covalent molecular substances change state you are overcoming the **intermolecular forces**
- The stronger the forces the more energy need to break the attraction
- **Intermolecular forces** are much weaker than covalent bonds, so many covalent substances are liquid or gases at room temperature
- Substance with a low melting and boiling point are said to be very **volatile**
- The strength of the intermolecular forces increases with
  - the **size** of the molecule
  - the increase in the **polarity** of the molecule
  - Drawing the structure of the molecule helps identify and rank molecules according to boiling point as the following example shows:



#### Worked Example

Place these three molecules in the correct order from lowest to highest boiling point and explain your reasoning:

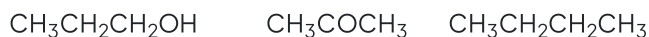

#### Answer:

**Step 1:** The first thing to do is find the approximate relative molecular mass:

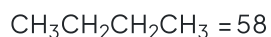
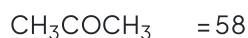

This tells you the molecules are approximately the same size so the dispersion forces will be similar

**Step 2:** Draw the structures of the molecules and identify the intermolecular forces present

YOUR NOTES



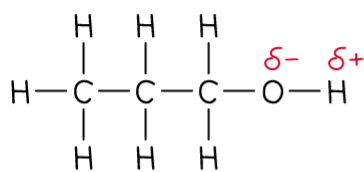

HYDROGEN BONDING

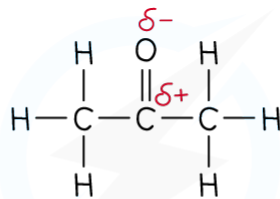

DIPOLE-DIPOLE ATTRACTIONS

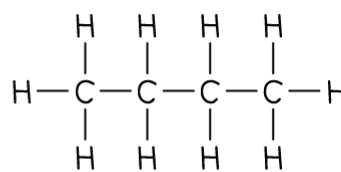

DISPERSION FORCES

Copyright © Save My Exams. All Rights Reserved

YOUR NOTES



So, the order of boiling from lowest to highest is:



## Solubility

- The general principle is that 'like dissolves like' so non-polar substances mostly dissolve in non-polar solvents, like hydrocarbons and they form dispersion forces between the solvent and the solute
- Polar covalent substances generally dissolve in polar solvents as a result of dipole-dipole interactions or the formation of hydrogen bonds between the solute and the solvent
- A good example of this is seen in organic molecules such as alcohols and water:

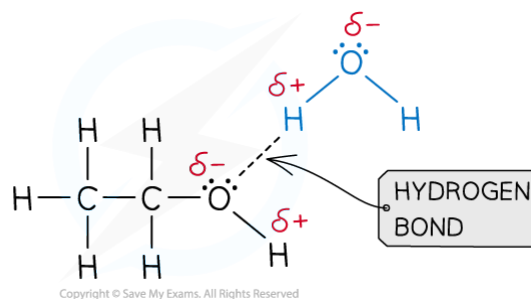

Copyright © Save My Exams. All Rights Reserved

### Hydrogen bonds form between ethanol and water

- As covalent molecules become larger their solubility can decrease as the polar part of the molecule is only a smaller part of the overall structure
  - This effect is seen in alcohols for example where ethanol,  $\text{C}_2\text{H}_5\text{OH}$ , is readily soluble but hexanol,  $\text{C}_6\text{H}_{13}\text{OH}$ , is not
- Polar covalent substances are unable to dissolve well in non-polar solvents as their dipole-dipole attractions are unable to interact well with the solvent
- Giant covalent substances generally don't dissolve in any solvents as the energy needed to overcome the strong covalent bonds in the lattice structures is too great

## Conductivity

- As covalent substances do not contain any freely moving charged particles they are unable to conduct electricity in either the solid or liquid state
- However, under certain conditions some polar covalent molecules can ionise and will conduct electricity

- Some giant covalent structures are capable of conducting electricity due to delocalised electrons, as seen in Section 4.1.11 **Giant Covalent Structures**, but they are exceptions to the general rule

YOUR NOTES

**Comparing the Properties of Covalent Compounds Table**

	Non-polar covalent substances	Polar covalent substances	Giant covalent substances	Ionic substances
Melting and boiling point	Low	Low	Very high	Very high
Volatility	Highest	High	Low	Low
Solubility in polar solvents	Insoluble	Some solubility depending on molecular size	Insoluble	Soluble
Solubility in non-polar solvents	Soluble	Some solubility depending on molecular size	None	Insoluble
Electrical conductivity	None	None	None – except graphite, graphene	Only when molten or aqueous

Copyright © Save My Exams. All Rights Reserved

### Worked Example

Compound X has the following properties:

Melting point	Electrical conductivity	
1450 °C	solid	molten
	poor	poor

Copyright © Save My Exams. All Rights Reserved

What is the most probable structure of X?

- A. Network covalent
- B. Polar covalent molecule
- C. Ionic lattice
- D. Metallic lattice

**Answer:**

The correct option is **A**

- A high melting point is characteristic of a giant structure, which could be metallic, ionic or covalent
- The poor conductivity as a liquid and solid would match a giant covalent or network covalent structure

YOUR NOTES



4.3.4 Metallic Bonding

YOUR NOTES



### Metallic Bonding

- **Metal** atoms are tightly packed together in **lattice** structures
- When the metal atoms are in **lattice** structures, the electrons in their outer shells are free to move throughout the structure
- The free-moving **electrons** are called '**delocalised**' electrons and they are not bound to their atom
- When the electrons are **delocalised**, the metal atoms become **positively** charged
- The positive charges **repel** each other and keep the neatly arranged lattice in place
- There are very strong **electrostatic forces** between the positive metal centres and the 'sea' of delocalised electrons

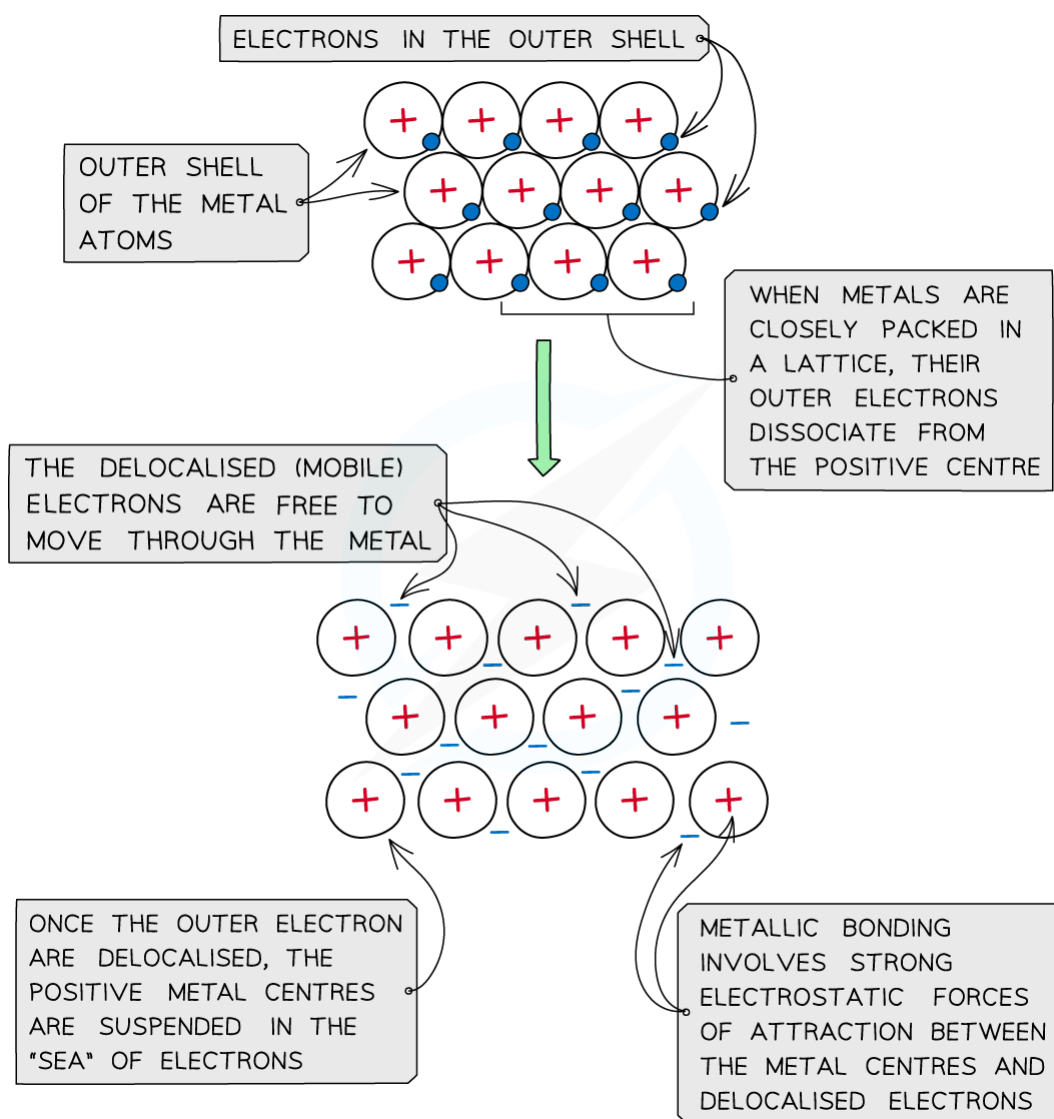

Copyright © Save My Exams. All Rights Reserved

**The positive metal centres are suspended in a 'sea' of delocalised electrons**

## Properties of Metals

- Metallic compounds are **malleable**
  - When a force is applied, the metal layers can slide
  - The **attractive forces** between the metal ions and electrons act in all directions
  - So when the layers slide, the metallic bonds are re-formed
  - The lattice is not broken and has changed shape

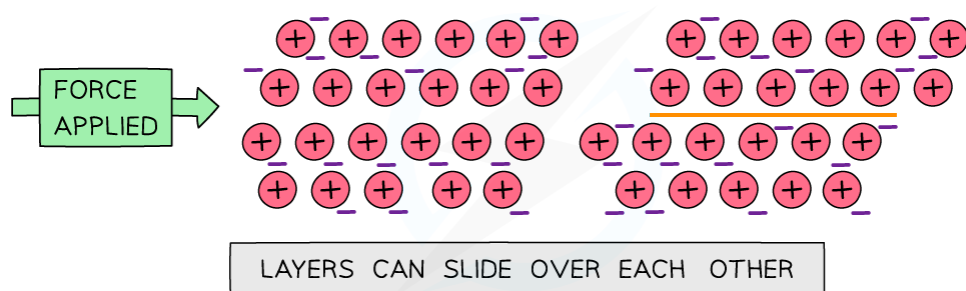

Copyright © Save My Exams. All Rights Reserved

- Metallic compounds are **strong** and **hard**
  - Due to the strong attractive forces between the metal ions and delocalised electrons
- Metals have **high melting** and **boiling points**

## Conductivity

- Metals can **conduct electricity** when in the **solid** or **liquid** state
  - As both in the solid and liquid state there are **mobile electrons** which can freely move around and conduct electricity
- Since the bonding in metals is **non-directional**, it does not really matter how the **cations** are oriented relative to each other
- The metal **cations** can be moved around and there will still be delocalised electrons available to hold the **cations** together

### Metallic Bonding Summary Table

YOUR NOTES





YOUR NOTES



Property	Explanation
<p><b>High melting and boiling points</b></p>	<p>Positive metal atom centres and the delocalised electrons in a metallic lattice have strong <b>electrostatic forces</b> between them</p> <p>Therefore, high energy is needed to <b>overcome</b> the strong forces of attraction</p> <p>As the number of mobile charges increase from left to right of the Periodic Table, the melting and boiling points increase as the <b>electrostatic forces</b> become <b>stronger</b></p>
<p><b>Electrical Conductivity</b></p>	<p>When a <b>potential difference</b> is applied to the metallic lattice, the delocalised electrons repel away from the negative terminal and move towards the positive terminal</p> <p>As the number of valence electrons increases across the Period, the number of <b>delocalised charges</b> also increases:</p> <ul style="list-style-type: none"> <li>◦ Sodium = 1 valence electron</li> <li>◦ Magnesium = 2 valence electrons</li> <li>◦ Aluminium = 3 valence electrons</li> <li>◦ Etc.</li> </ul> <p>Therefore the ability to conduct electricity also increases</p>

Copyright © Save My Exams. All Rights Reserved

## Strength of Metallic Bonds

Not all metallic bonds are equal. There are several factors that affect the **strength** of a metallic bond:

### The charge on the metal ion

- The **greater the charge** on the metal ion, the greater the number of electrons in the sea of delocalised electrons and the greater the **charge difference** between the ions and the electrons
- A greater charge difference leads to a **stronger** electrostatic attraction, and therefore a stronger metallic bond
- This effect can be seen in melting point data across a period, as the charge on the metal ion **increases** without a significant change in ionic radius:

Group	1	2	3 (13)
<b>Metal</b>	Sodium	Magnesium	Aluminium
<b>Melting point / K</b>	371	923	933

### The radius of the metal ion

- Metal ions with **smaller ionic radii** exert a greater attraction on the sea of delocalised electrons
- This greater attraction means a **stronger** metallic bond, requiring more energy to break
- This can be seen in data from metals, descending a group, where the charge on the ion remains constant but the ionic radius increases:

Period	1	2	3
<b>Metal</b>	Sodium	Potassium	Rubidium
<b>Melting point / K</b>	371	336	312

YOUR NOTES



### 4.3.5 Trends in Melting Points of Metals

#### Trends in Melting Points of Metals

- The **strength** of electrostatic attraction can be increased by:
  - **Increasing** the number of **delocalised electrons** per metal atom
  - **Increasing** the **positive charges** on the metal centres in the lattice
  - **Decreasing** the **size** of the metal ions
- These factors can be seen in the trends across a period and down a group

Melting points of metals across a period

- If you compare the electron configuration of sodium, magnesium and aluminium you can see the number of valence electrons increases
  - **Na** =  $1s^2 2s^2 2p^6 3s^1$
  - **Mg** =  $1s^2 2s^2 2p^6 3s^2$
  - **Al** =  $1s^2 2s^2 2p^6 3s^2 3p^1$
- Aluminium ions are also a smaller size than magnesium ions or sodium ions and these two factors lead to **stronger** metallic bonding which can be seen in the melting points
- The **stronger** the metallic bonding, the **more energy** is need to break the metallic lattice and so the **higher** the melting point
- As we go across period 3 we can see the effect of stronger metallic bonding on the metals
  - Remember only the first three elements have metallic bonding in this graph

YOUR NOTES



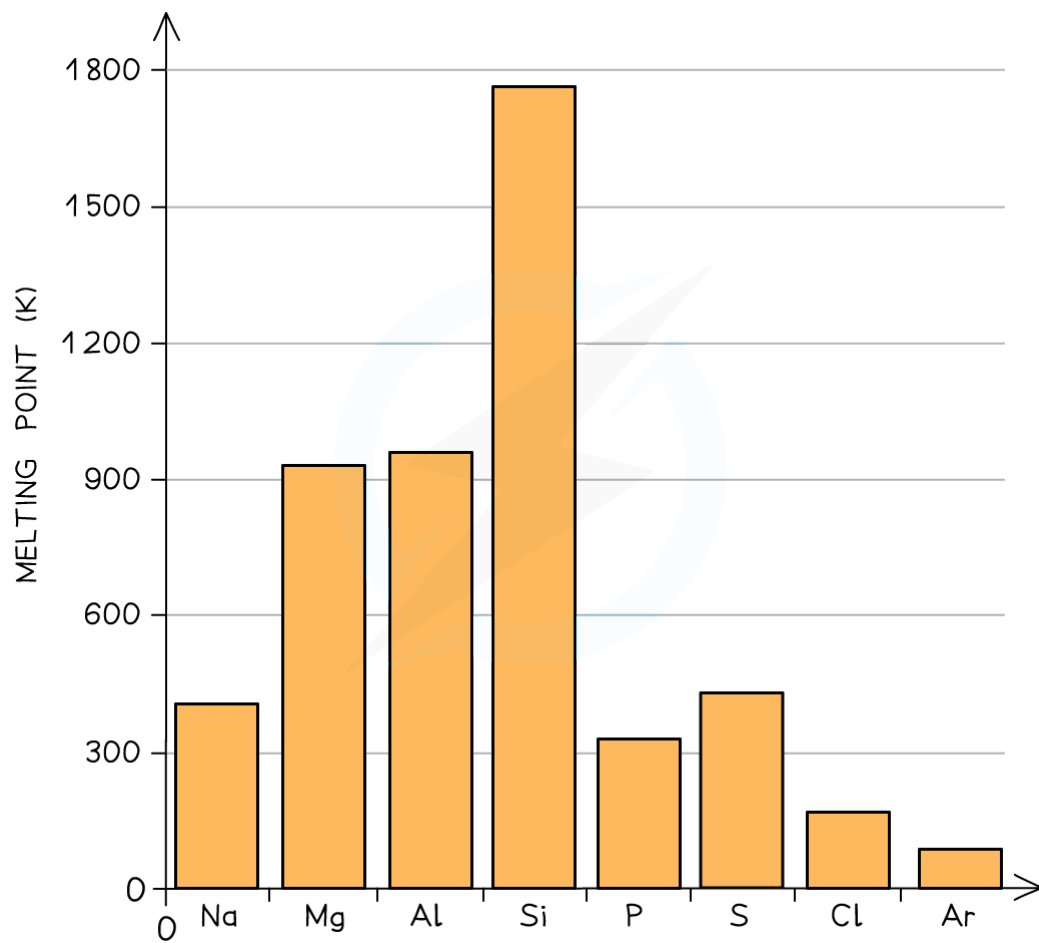

Melting points as you go across a period. The metallic bonding gets stronger from Na to Al

### Melting points of metals down a group

- As you go **down the group** the size of the cation increases so this **decreases the attraction** between the valence electrons and the metallic lattice, leading to a reduction of the melting point

YOUR NOTES



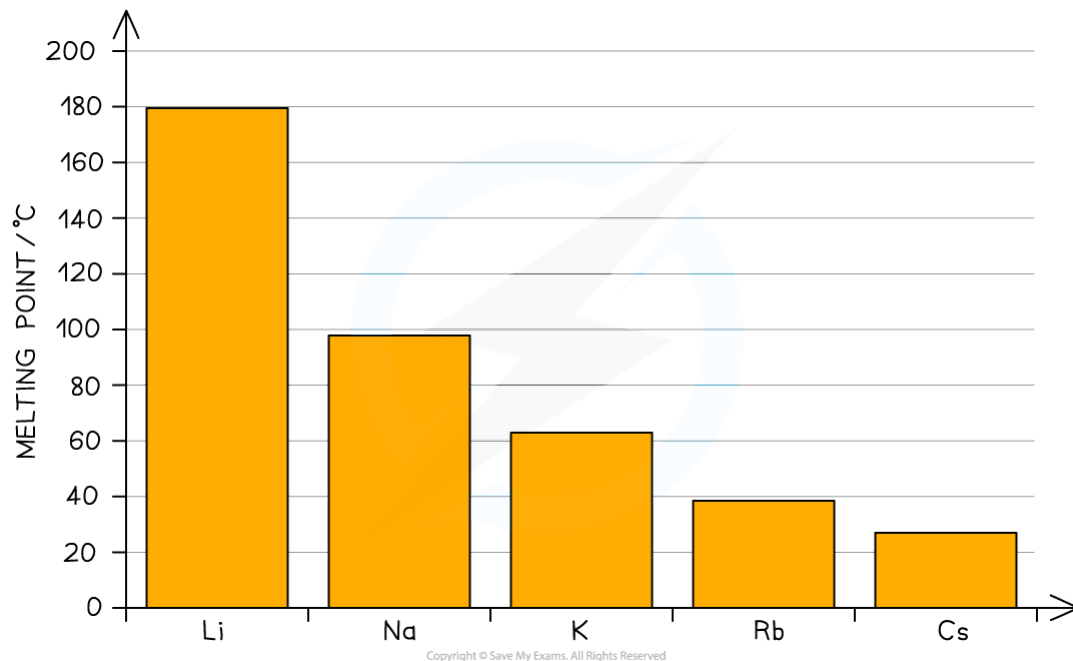

**Melting points as you go down a group of metals. The metallic bonding gets weaker from Li to Cs**



### Exam Tip

You see from the graph that the melting point of aluminium is not that much higher than magnesium. It is a reminder to us that these are trends and not rules about melting points and sometimes there are other factors which can result in subtle differences from what was expected. One factor here is the metal packing structure - this can also influence the melting point, but it is beyond what is required in the IB Chemistry syllabus. You just need to learn and explain the broad trends

YOUR NOTES



4.3.6 Alloys & their Properties

YOUR NOTES



Alloys

- Alloys are mixtures of metals, where the metals are mixed together physically but are not chemically combined
- They can also be made from metals mixed with nonmetals such as carbon
- Ions of the different metals are spread throughout the **lattice** and are bound together by the **delocalized** electrons
- It is possible to form alloys because of the **non-directional** nature of the metallic bonds

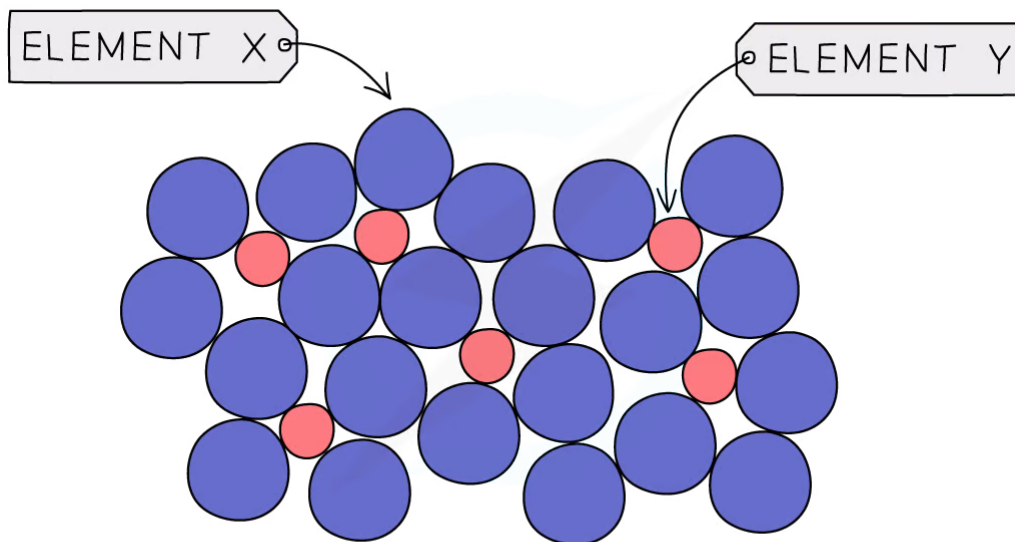

Copyright © Save My Exams. All Rights Reserved



***In a metallic lattice the regular structure of metal cations (shown by Element Y) is disrupted by the presence of another element (Element X)***

- Alloys have distinct properties due to the different packing of the cations in the lattice
- Alloys often have properties that can be very **different** to the metals they contain, for example they can have greater **strength, hardness** or **resistance** to **corrosion** or extreme **temperatures**
- Alloys contain atoms of **different** sizes, which **distorts** the regular arrangements of cations
- This makes it more difficult for the layers to slide over each other, so they are usually much harder than the pure metal
- Below is a table of some common alloys and their uses:

**Common Alloys and their Uses Table**

Alloy	Elements present	Properties	Uses
<b>Brass</b>	copper and zinc	strong and resistant to corrosion	door handles, hinges, musical instruments
<b>Steel</b>	iron, carbon and other elements like chromium, vanadium, and molybdenum	very strong	construction, bridges, cars
<b>Solder</b>	lead and tin	low melting point	joining metals in electrical circuits and jewellery
<b>Bronze</b>	copper and tin	hard and strong resistant to corrosion	medals, sculptures, ship fittings

Copyright © Save My Exams. All Rights Reserved

YOUR NOTES



### Exam Tip

You don't need to learn the specific alloys, but you should be able to use examples you know to explain why alloys have the properties they do compared to pure metals