

Physics
Higher level
Paper 1

Tuesday 30 October 2018 (afternoon)

1 hour

Instructions to candidates

- Do not open this examination paper until instructed to do so.
- Answer all the questions.
- For each question, choose the answer you consider to be the best and indicate your choice on the answer sheet provided.
- A clean copy of the **physics data booklet** is required for this paper.
- The maximum mark for this examination paper is **[40 marks]**.

1. The length of the side of a cube is $2.0 \text{ cm} \pm 4\%$. The mass of the cube is $24.0 \text{ g} \pm 8\%$. What is the percentage uncertainty of the density of the cube?
- A. $\pm 2\%$
B. $\pm 8\%$
C. $\pm 12\%$
D. $\pm 20\%$
2. A truck has an initial speed of 20 m s^{-1} . It decelerates at 4.0 m s^{-2} . What is the distance taken by the truck to stop?
- A. 2.5 m
B. 5.0 m
C. 50 m
D. 100 m
3. A runner starts from rest and accelerates at a constant rate throughout a race. Which graph shows the variation of speed v of the runner with distance travelled s ?

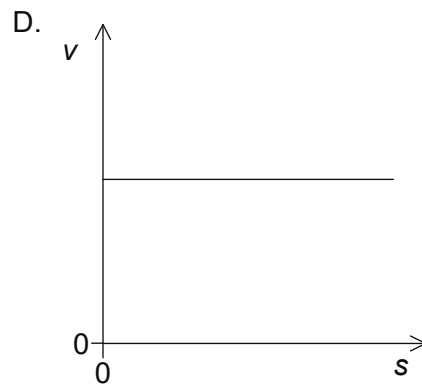
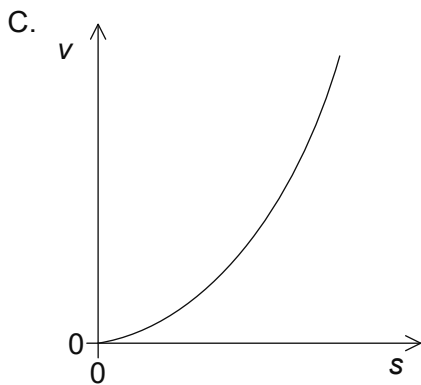
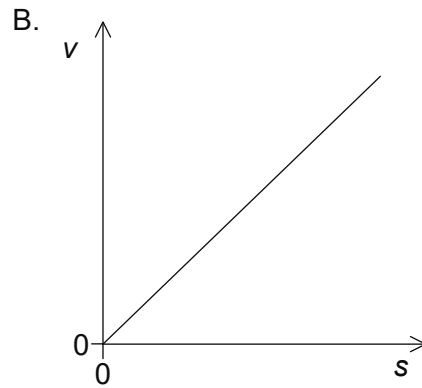
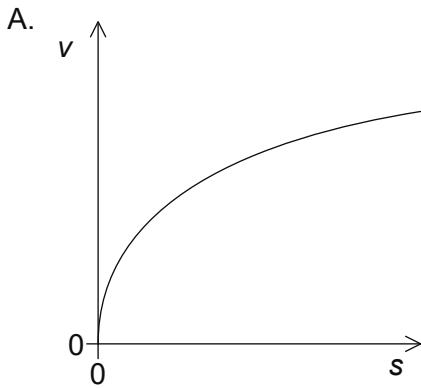

4. A projectile is fired at an angle to the horizontal. The path of the projectile is shown.

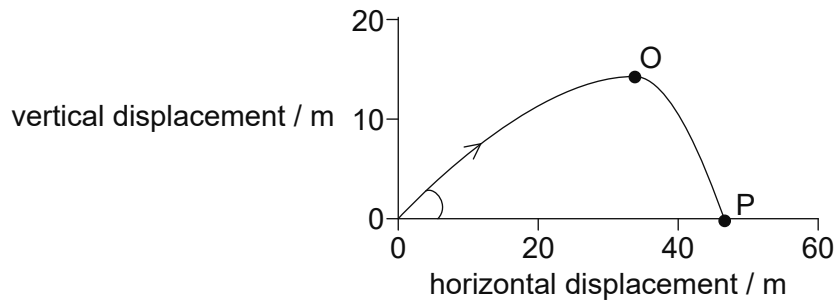

Which gives the magnitude of the horizontal component and the magnitude of the vertical component of the velocity of the projectile between O and P?

| | Magnitude of horizontal component of velocity | Magnitude of vertical component of velocity |
|----|------------------------------------------------------|----------------------------------------------------|
| A. | decreases | increases |
| B. | decreases | constant |
| C. | constant | increases |
| D. | constant | constant |

5. A mass m attached to a string of length R moves in a vertical circle with a constant speed. The tension in the string at the top of the circle is T . What is the kinetic energy of the mass at the top of the circle?

- A. $\frac{R(T + mg)}{2}$
- B. $\frac{R(T - mg)}{2}$
- C. $\frac{Rmg}{2}$
- D. $\frac{R(2T + mg)}{2}$

6. A compressed spring is used to launch an object along a horizontal frictionless surface. When the spring is compressed through a distance x and released, the object leaves the spring at speed v . What is the distance through which the spring must be compressed for the object to leave the spring at $\frac{v}{2}$?

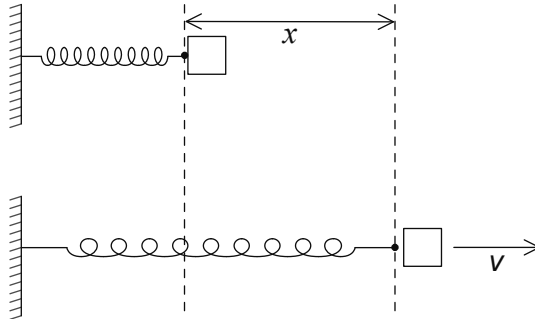

- A. $\frac{x}{4}$
- B. $\frac{x}{2}$
- C. $\frac{x}{\sqrt{2}}$
- D. $x\sqrt{2}$

7. Three forces act at a point. In which diagram is the point in equilibrium?

A.

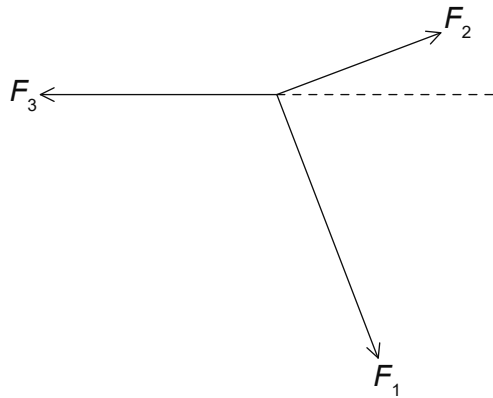

B.

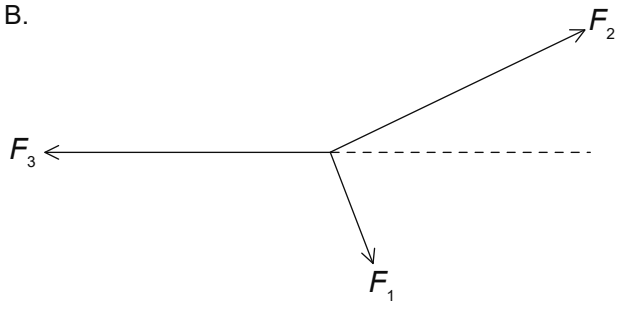

C.

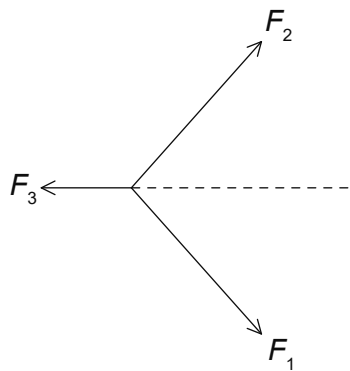

D.

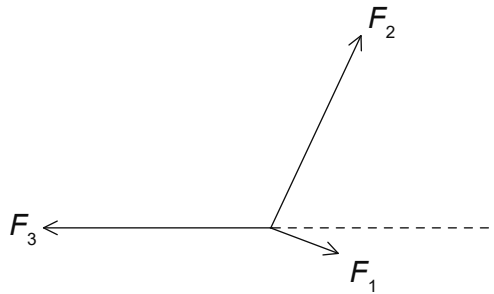

8. A solid substance has just reached its melting point. Thermal energy is supplied to the substance at a constant rate. Which graph shows the variation of the temperature T of the substance with energy E supplied?

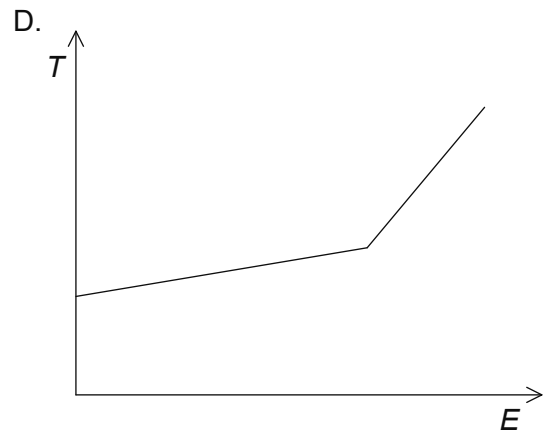
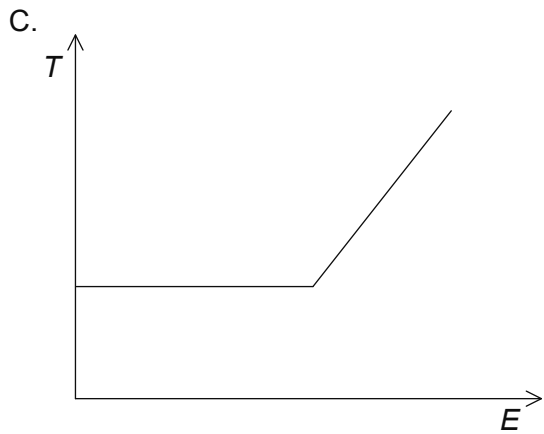
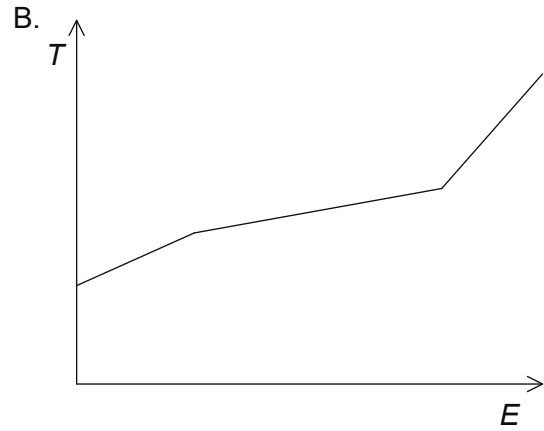
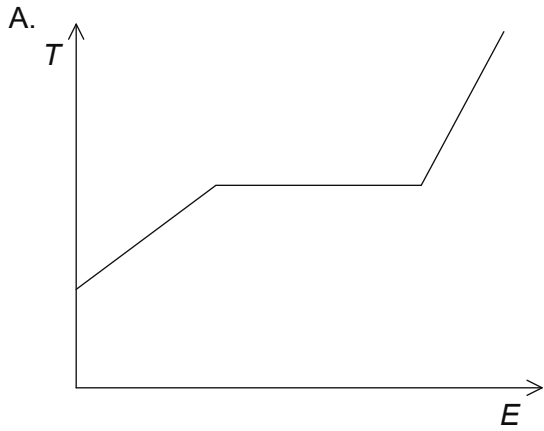

9. A container is filled with a mixture of helium and oxygen at the same temperature. The molar mass of helium is 4 g mol^{-1} and that of oxygen is 32 g mol^{-1} .

What is the ratio $\frac{\text{average speed of helium molecules}}{\text{average speed of oxygen molecules}}$?

- A. $\frac{1}{8}$
- B. $\frac{1}{\sqrt{8}}$
- C. $\sqrt{8}$
- D. 8

10. Container X contains 1.0 mol of an ideal gas. Container Y contains 2.0 mol of the ideal gas. Y has four times the volume of X. The pressure in X is twice that in Y.

What is $\frac{\text{temperature of gas in X}}{\text{temperature of gas in Y}}$?

- A. $\frac{1}{4}$
- B. $\frac{1}{2}$
- C. 1
- D. 2

11. A particle moving in a circle completes 5 revolutions in 3 s. What is the frequency?

- A. $\frac{3}{5}$ Hz
- B. $\frac{5}{3}$ Hz
- C. $\frac{3\pi}{5}$ Hz
- D. $\frac{5\pi}{3}$ Hz

12. A longitudinal wave moves through a medium. Relative to the direction of energy transfer through the medium, what are the displacement of the medium and the direction of propagation of the wave?

| | Displacement of medium | Direction of propagation of wave |
|----|-------------------------------|-----------------------------------------|
| A. | parallel | perpendicular |
| B. | parallel | parallel |
| C. | perpendicular | parallel |
| D. | perpendicular | perpendicular |

13. L is a point source of light. The intensity of the light at a distance $2x$ from L is I . What is the intensity at a distance $3x$ from L?

A. $\frac{4}{9}I$

B. $\frac{2}{3}I$

C. $\frac{3}{2}I$

D. $\frac{9}{4}I$

14. X and Y are two coherent sources of waves. The phase difference between X and Y is zero. The intensity at P due to X and Y separately is I . The wavelength of each wave is 0.20 m.

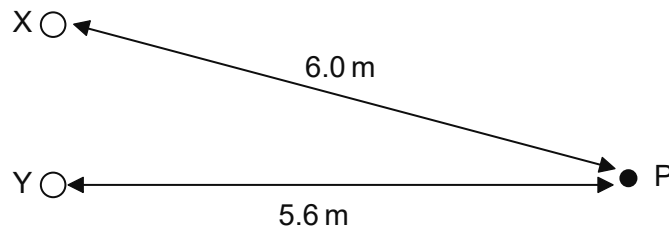

What is the resultant intensity at P?

A. 0

B. I

C. $2I$

D. $4I$

15. Light is incident at the boundary between air and diamond. The speed of light in diamond is less than the speed of light in air. The angle of incidence i of the light is greater than the critical angle. Which diagram is correct for this situation?

A.

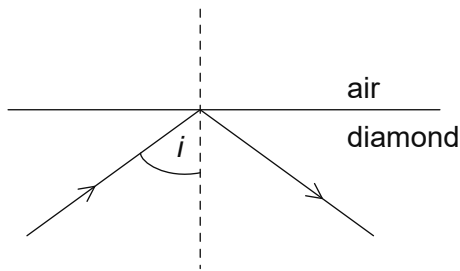

B.

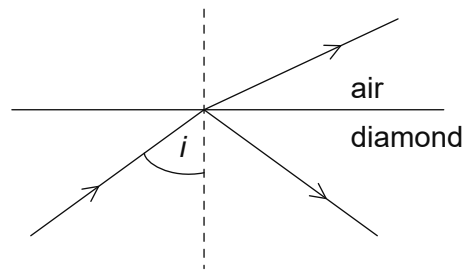

C.

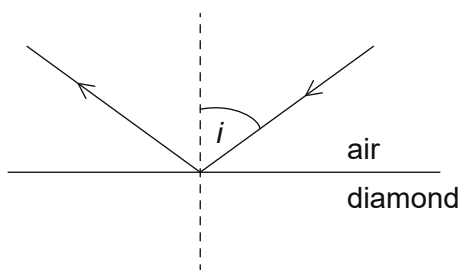

D.

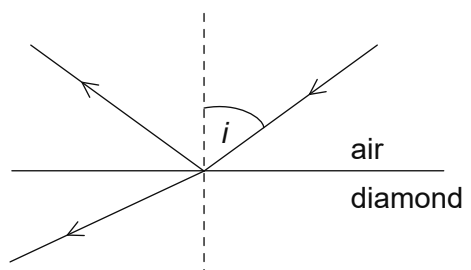

16. A wire of length L is used in an electric heater. When the potential difference across the wire is 200 V, the power dissipated in the wire is 1000 W. The same potential difference is applied across a second similar wire of length $2L$. What is the power dissipated in the second wire?

- A. 250 W
- B. 500 W
- C. 2000 W
- D. 4000 W

17. A combination of four identical resistors each of resistance R are connected to a source of emf ε of negligible internal resistance. What is the current in the resistor X ?

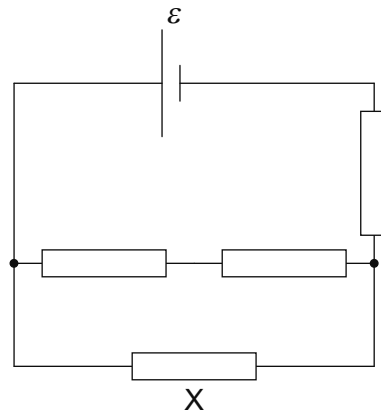

- A. $\frac{\varepsilon}{5R}$
- B. $\frac{3\varepsilon}{10R}$
- C. $\frac{2\varepsilon}{5R}$
- D. $\frac{3\varepsilon}{5R}$
18. Two parallel wires P and Q are perpendicular to the page and carry equal currents. Point S is the same distance from both wires. The arrow shows the magnetic field at S due to P and Q.

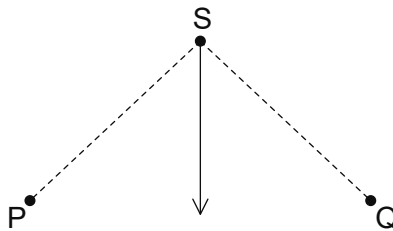

What are the correct directions for the current at P and the current at Q?

| | Current direction at P | Current direction at Q |
|----|------------------------|------------------------|
| A. | into page | out of page |
| B. | out of page | out of page |
| C. | into page | into page |
| D. | out of page | into page |

19. A particle of mass m and charge of magnitude q enters a region of uniform magnetic field B that is directed into the page. The particle follows a circular path of radius R . What are the sign of the charge of the particle and the speed of the particle?

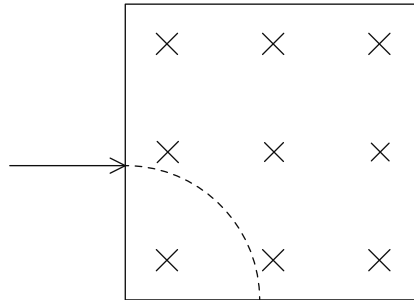

| | Charge of the particle | Speed of the particle |
|----|------------------------|------------------------|
| A. | positive | $\frac{qBR}{m}$ |
| B. | negative | $\frac{qBR}{m}$ |
| C. | negative | $\sqrt{\frac{qBR}{m}}$ |
| D. | positive | $\sqrt{\frac{qBR}{m}}$ |

20. In the Rutherford-Geiger-Marsden scattering experiment it was observed that a small percentage of alpha particles are deflected through large angles.

Three features of the atom are

- I. the nucleus is positively charged
- II. the nucleus contains neutrons
- III. the nucleus is much smaller than the atom.

Which features can be inferred from the observation?

- A. I and II only
- B. I and III only
- C. II and III only
- D. I, II and III

21. The graph shows the variation of the number of neutrons N with the atomic number Z for stable nuclei. The same scale is used in the N and Z axes.

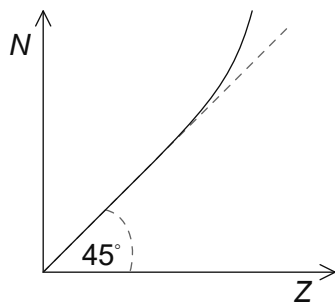

Which information can be inferred from the graph?

- I. For stable nuclei with high Z , N is larger than Z .
 - II. For stable nuclei with small Z , $N = Z$.
 - III. All stable nuclei have more neutrons than protons.
- A. I and II only
 - B. I and III only
 - C. II and III only
 - D. I, II and III
22. The following decay is observed.

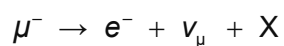

What is particle X ?

- A. γ
- B. $\bar{\nu}_e$
- C. Z^0
- D. ν_e

23. What is the function of control rods in a nuclear power plant?
- A. To slow neutrons down
 - B. To regulate fuel supply
 - C. To exchange thermal energy
 - D. To regulate the reaction rate
24. A photovoltaic panel of area S has an efficiency of 20%. A second photovoltaic panel has an efficiency of 15%. What is the area of the second panel so that both panels produce the same power under the same conditions?
- A. $\frac{S}{3}$
 - B. $\frac{3S}{4}$
 - C. $\frac{5S}{4}$
 - D. $\frac{4S}{3}$
25. Light of intensity I_0 is incident on a snow-covered area of Earth. In a model of this situation, the albedo of the cloud is 0.30 and the albedo for the snow surface is 0.80. What is the intensity of the light at P due to the incident ray I_0 ?

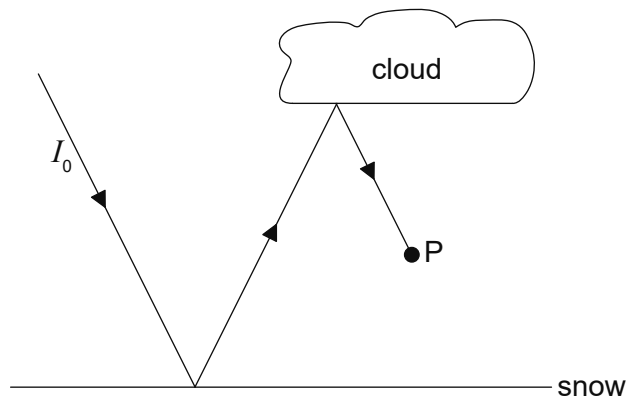

- A. $0.14 I_0$
- B. $0.24 I_0$
- C. $0.50 I_0$
- D. $0.55 I_0$

26. An object undergoing simple harmonic motion (SHM) has a period T and total energy E . The amplitude of oscillations is halved. What are the new period and total energy of the system?

| | Period | Total energy |
|----|---------------|---------------------|
| A. | $\frac{T}{2}$ | $\frac{E}{4}$ |
| B. | $\frac{T}{2}$ | $\frac{E}{2}$ |
| C. | T | $\frac{E}{4}$ |
| D. | T | $\frac{E}{2}$ |

27. The graph shows the variation with diffraction angle of the intensity of light when monochromatic light is incident on four slits.

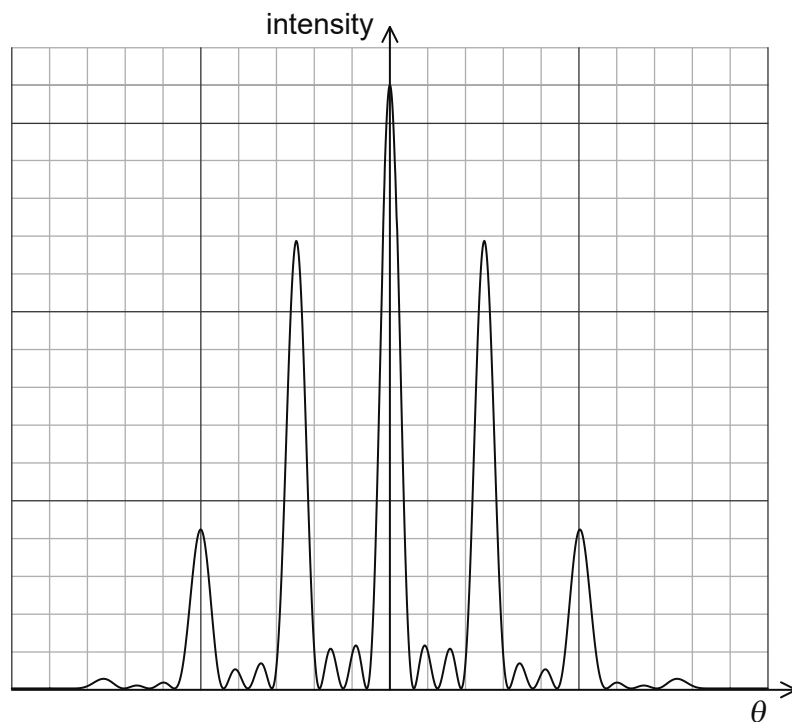

The number of slits is increased keeping the width and the separation of the slits unchanged.

Three possible changes to the pattern are

- I. the separation of the primary maxima increases
- II. the intensity of the primary maxima increases
- III. the width of the primary maxima decreases.

Which of the possible changes are correct?

- A. I and II only
- B. I and III only
- C. II and III only
- D. I, II and III

28. A beam of monochromatic light is incident normally on a diffraction grating. The grating spacing is d . The angles between the different orders are shown on the diagram.

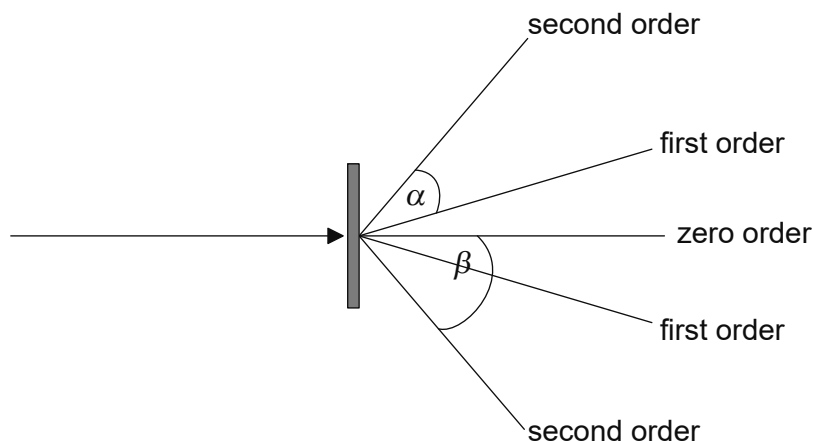

What is the expression for the wavelength of light used?

- A. $\frac{d \sin \alpha}{2}$
- B. $\frac{d \sin \beta}{2}$
- C. $d \sin \alpha$
- D. $d \sin \beta$
29. An ambulance siren emits a sound of frequency 1200 Hz. The speed of sound in air is 330 m s^{-1} . The ambulance moves towards a stationary observer at a constant speed of 40 m s^{-1} . What is the frequency heard by the observer?
- A. $\frac{1200 \times 330}{370} \text{ Hz}$
- B. $\frac{1200 \times 290}{330} \text{ Hz}$
- C. $\frac{1200 \times 370}{330} \text{ Hz}$
- D. $\frac{1200 \times 330}{290} \text{ Hz}$

30. Two point charges Q_1 and Q_2 are one metre apart. The graph shows the variation of electric potential V with distance x from Q_1 .

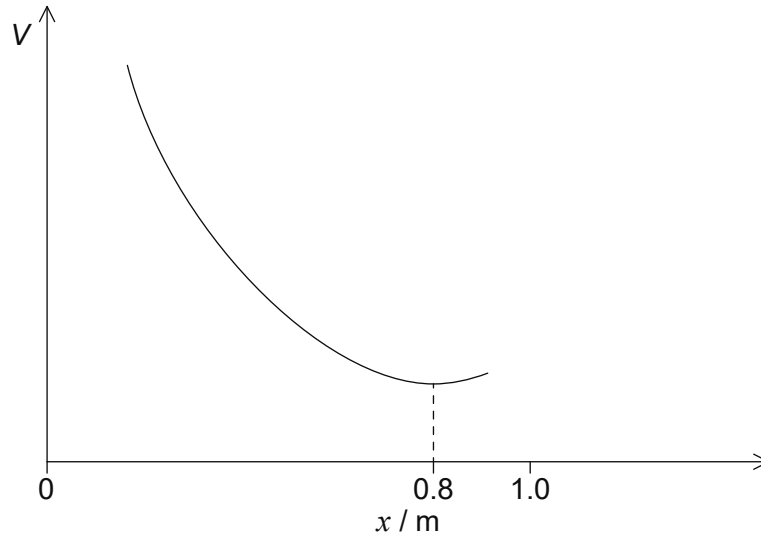

What is $\frac{Q_1}{Q_2}$?

- A. $\frac{1}{16}$
 - B. $\frac{1}{4}$
 - C. 4
 - D. 16
31. The gravitational potential at point P due to Earth is V .

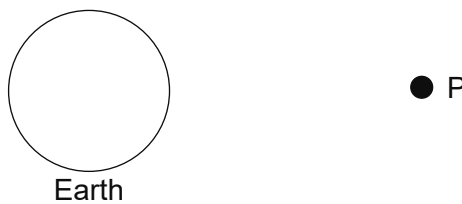

What is the definition of the gravitational potential at P?

- A. Work done per unit mass to move a point mass from infinity to P
- B. Work done per unit mass to move a point mass from P to infinity
- C. Work done to move a point mass from infinity to P
- D. Work done to move a point mass from P to infinity

32. The escape speed for the Earth is v_{esc} . Planet X has half the density of the Earth and twice the radius. What is the escape speed for planet X?

- A. $\frac{v_{\text{esc}}}{2}$
- B. $\frac{v_{\text{esc}}}{\sqrt{2}}$
- C. v_{esc}
- D. $\sqrt{2}v_{\text{esc}}$

33. A ring of area S is in a uniform magnetic field X . Initially the magnetic field is perpendicular to the plane of the ring. The ring is rotated by 180° about the axis in time T .

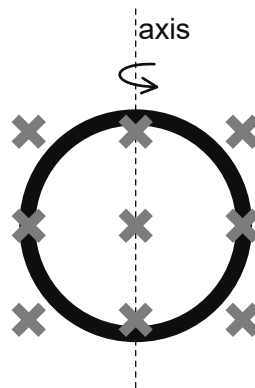

What is the average induced emf in the ring?

- A. 0
- B. $\frac{XS}{2T}$
- C. $\frac{XS}{T}$
- D. $\frac{2XS}{T}$

34. The graph shows the variation of the peak output power P with time of an alternating current (ac) generator.

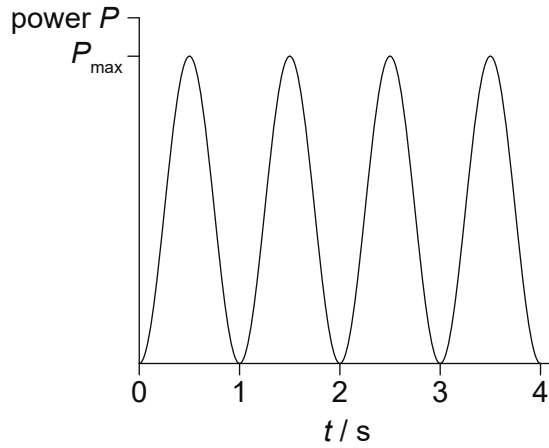

Which graph shows the variation of the peak output power with time when the frequency of rotation is decreased?

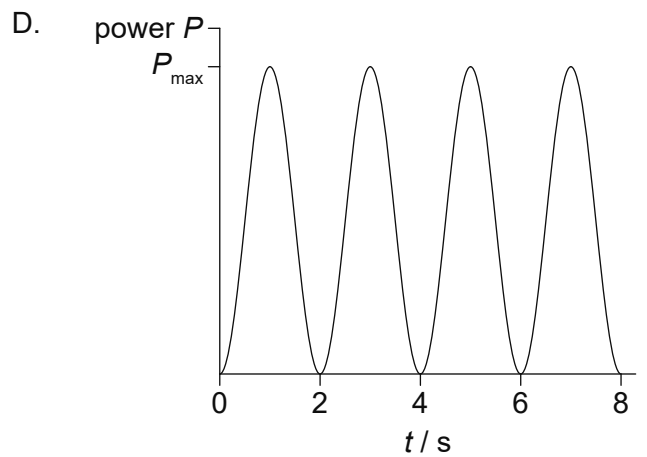
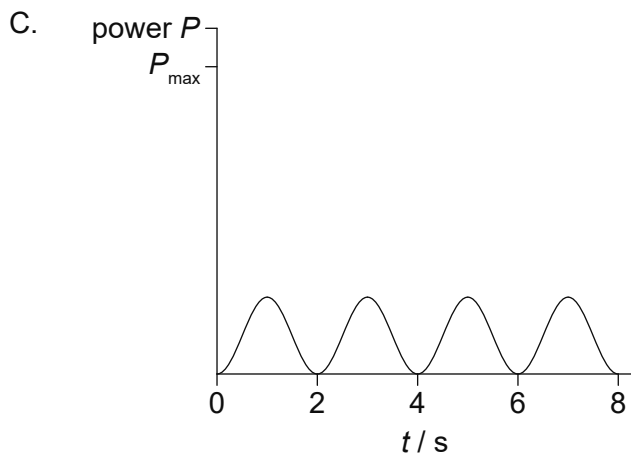
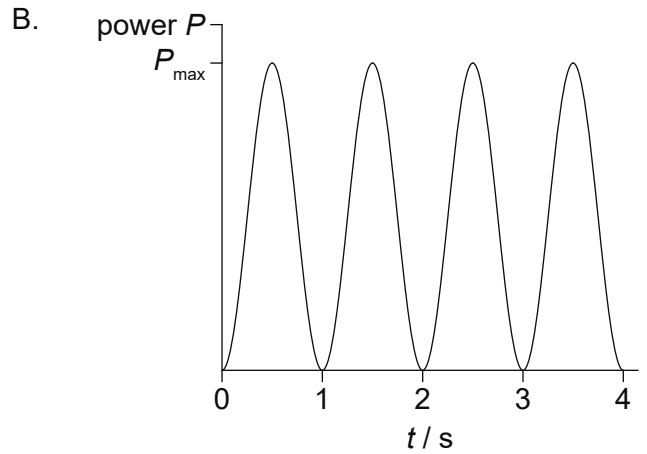
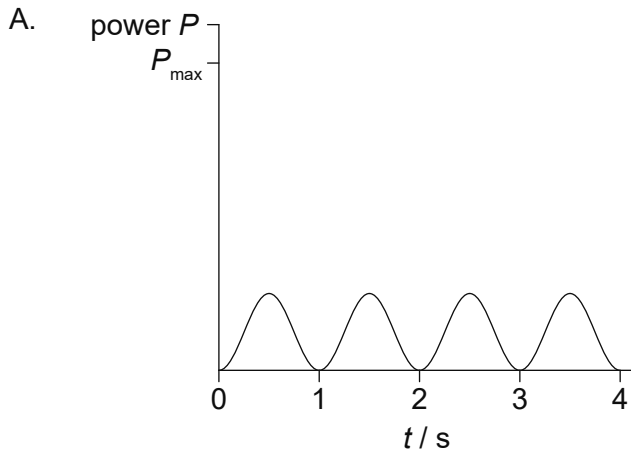

35. A current of 1.0×10^{-3} A flows in the primary coil of a step-up transformer. The number of turns in the primary coil is N_p and the number of turns in the secondary coil is N_s . One coil has 1000 times more turns than the other coil.

What is $\frac{N_p}{N_s}$ and what is the current in the secondary coil for this transformer?

| | $\frac{N_p}{N_s}$ | Current in secondary coil / A |
|----|-------------------|-------------------------------|
| A. | $\frac{1}{1000}$ | 1.0×10^{-6} |
| B. | 1000 | 1.0 |
| C. | $\frac{1}{1000}$ | 1.0 |
| D. | 1000 | 1.0×10^{-6} |

36. Four identical capacitors of capacitance X are connected as shown in the diagram.

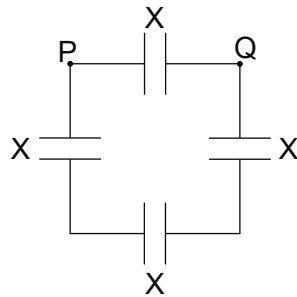

What is the effective capacitance between P and Q?

- A. $\frac{X}{3}$
- B. X
- C. $\frac{4X}{3}$
- D. 4X

37. When green light is incident on a clean zinc plate no photoelectrons are emitted. What change may cause the emission of photoelectrons?
- A. Using a metal plate with larger work function
 - B. Changing the angle of incidence of the green light on the zinc plate
 - C. Using shorter wavelength radiation
 - D. Increasing the intensity of the green light

38. Which is the correct Feynman diagram for pair annihilation and pair production?

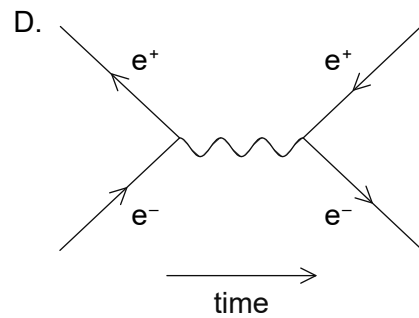
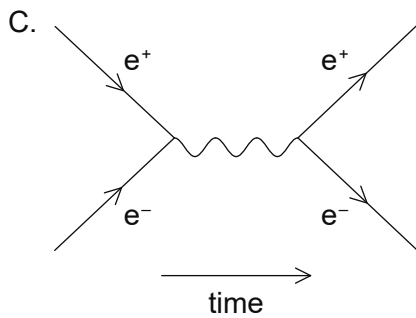
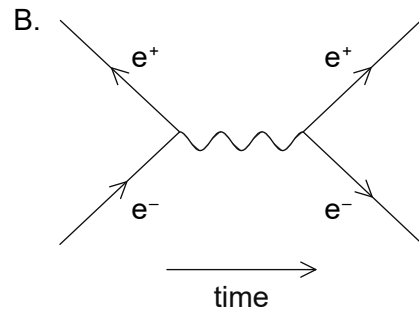
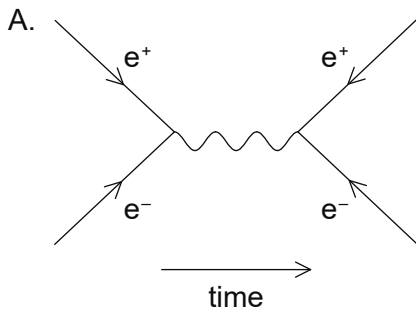

39. The graph shows the variation of the natural log of activity, $\ln(\text{activity})$, against time for a radioactive nuclide.

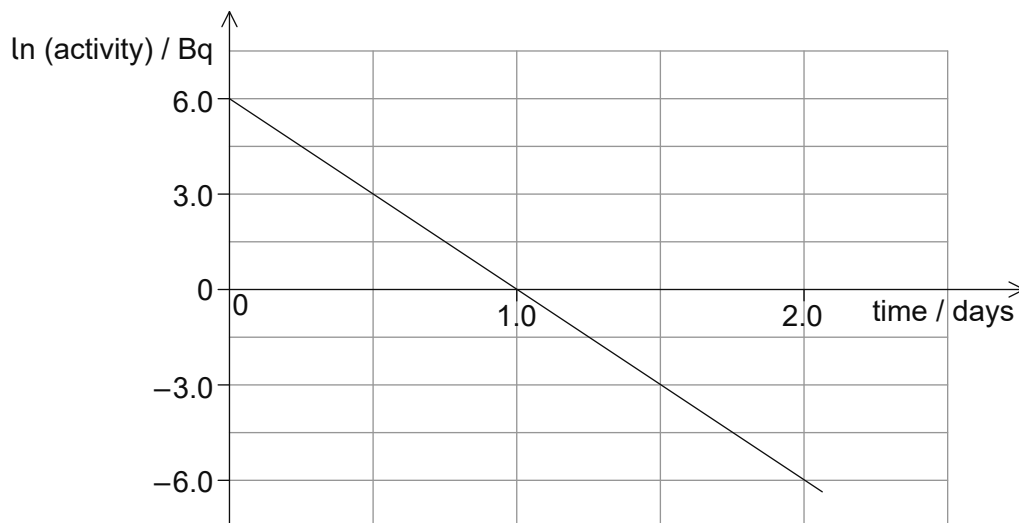

What is the decay constant, in days^{-1} , of the radioactive nuclide?

- A. $\frac{1}{6}$
- B. $\frac{1}{3}$
- C. 3
- D. 6
40. A radioactive nuclide is known to have a very long half-life.

Three quantities known for a pure sample of the nuclide are

- I. the activity of the nuclide
- II. the number of nuclide atoms
- III. the mass number of the nuclide.

What quantities are required to determine the half-life of the nuclide?

- A. I and II only
- B. I and III only
- C. II and III only
- D. I, II and III
-