



MARKSCHEME

May 2011

CHEMISTRY

Higher Level

Paper 2

*This markscheme is **confidential** and for the exclusive use of examiners in this examination session.*

*It is the property of the International Baccalaureate and must **not** be reproduced or distributed to any other person without the authorization of IB Cardiff.*

General Marking Instructions

Subject Details: Chemistry HL Paper 2 Markscheme

Mark Allocation

Candidates are required to answer **ALL** questions in Section A [**40 marks**] and **TWO** questions in Section B [**2 × 25 marks**]. Maximum total = [**90 marks**].

1. A markscheme often has more marking points than the total allows. This is intentional. Do not award more than the maximum marks allowed for part of a question.
2. Each marking point has a separate line and the end is signified by means of a semicolon (;).
3. An alternative answer or wording is indicated in the markscheme by a slash (/) – either wording can be accepted.
4. Words in brackets () in the markscheme are not necessary to gain the mark.
5. Words that are underlined are essential for the mark.
6. The order of marking points does not have to be as in the markscheme, unless stated otherwise.
7. If the candidate's answer has the same "meaning" or can be clearly interpreted as being of equivalent significance, detail and validity as that in the markscheme then award the mark. Where this point is considered to be particularly relevant in a question it is emphasized by writing **OWTTE** (or words to that effect).
8. Occasionally, a part of a question may require an answer that is required for subsequent marking points. If an error is made in the first marking point then it should be penalized.
9. Only consider units at the end of a calculation.
10. Significant digits should only be considered in the final answer. Penalize an **error of 2 or more digits** unless directed otherwise in the markscheme.

e.g. if the answer is 1.63:

2	<i>reject</i>
1.6	<i>accept</i>
1.63	<i>accept</i>
1.631	<i>accept</i>
1.6314	<i>reject</i>

11. If a question specifically asks for the name of a substance, do not award a mark for a correct formula, similarly, if the formula is specifically asked for, do not award a mark for a correct name.
12. If a question asks for an equation for a reaction, a balanced symbol equation is usually expected, do not award a mark for a word equation or an unbalanced equation unless directed otherwise in the markscheme.
13. Ignore missing or incorrect state symbols in an equation unless directed otherwise in the markscheme.

SECTION A

1. (a) $(\Delta H^\ominus = \sum \Delta H_{f, \text{products}}^\ominus - \sum \Delta H_{f, \text{reactants}}^\ominus)$
 $\Delta H_c^\ominus = (2 \times -242 + -394) - (-239) \text{ (kJ mol}^{-1}\text{)};$
 $\Delta H_c^\ominus = -639 \text{ (kJ mol}^{-1}\text{)};$ [2]
Award [2] for correct final answer.
Do not award M2 if M1 incorrect.
- (b) (i) $m(\text{methanol}) = (80.557 - 80.034) = 0.523 \text{ (g)};$
 $n(\text{methanol}) = \left(\frac{0.523 \text{ g}}{32.05 \text{ g mol}^{-1}} \right) = 0.0163 \text{ (mol)};$ [2]
Award [2] for correct final answer.
- (ii) $\Delta T = (26.4 - 21.5) = 4.9 \text{ (K)};$
 $q = (mc\Delta T) = 20.000 \times 4.18 \times 4.9 \text{ (J)} / 20.000 \times 4.18 \times 4.9 \times 10^{-3} \text{ (kJ)};$
 $0.41 \text{ (kJ)};$ [3]
Award [3] for correct final answer.
- (iii) $\Delta H_c^\ominus = -\frac{0.41 \text{ (kJ)}}{0.0163 \text{ (mol)}} / -25153 \text{ (J mol}^{-1}\text{)};$
 $= -25 \text{ (kJ mol}^{-1}\text{)};$ [2]
Award [2] for correct final answer.
Award [1] for (+)25 (kJ mol⁻¹).
- (c) (i) not at standard conditions/1 atm **and** 298 K/25 °C / ΔH_{vap} for water; [1]
- (ii) not all heat produced transferred to water / heat lost to surroundings/environment / OWTTE / incomplete combustion (of methanol) / water forms as H₂O(l) instead of H₂O(g); [1]
Do not allow just "heat lost".
- (d) $\Delta S^\ominus (= \sum S_{\text{products}}^\ominus - \sum S_{\text{reactants}}^\ominus) = 2 \times 189 + 214 - (240 + 1.5 \times 205);$
 $= 44.5 \text{ J K}^{-1} \text{ mol}^{-1} / 0.0445 \text{ kJ K}^{-1} \text{ mol}^{-1}$ [2]
Award [2] for correct final answer.
Do not award M2 if M1 incorrect.
- (e) temperature of 298 K;
 $\Delta G_c^\ominus = (\Delta H_c^\ominus - T\Delta S_c^\ominus) = -726 - 298 \times 44.5 \times 10^{-3} \text{ (kJ mol}^{-1}\text{)} /$
 $-726000 - 298 \times 44.5 \text{ (J mol}^{-1}\text{)};$
 $= -739 \text{ kJ mol}^{-1} / -7.39 \times 10^5 \text{ J mol}^{-1};$ [3]
Award [3] for correct final answer.
- (f) ΔG_c^\ominus is always negative **and** temperature won't alter spontaneity of reaction; [1]

2. (a) k increases with increase in T / k decreases with decrease in T ; [1]
Do not allow answers giving just the Arrhenius equation or involving $\ln k$ relationships.

(b) gradient = $-E_a/R$;
 $-30000 \text{ (K)} = -E_a/R$;
Allow value in range -28800 – 31300 (K) .

$E_a = (30000 \times 8.31) = 2.49 \times 10^5 \text{ J mol}^{-1} / 249 \text{ kJ mol}^{-1}$; [3]
Allow value in range 240 – 260 kJ mol^{-1} .
Allow [3] for correct final answer.

(c) $0.9 \times 0.200 = 0.180 \text{ (mol dm}^{-3}\text{)}$;

rate = $(0.244 \times (0.180)^2) = 7.91 \times 10^{-3} \text{ mol dm}^{-3} \text{ s}^{-1}$; [2]
Award [2] for correct final answer.
Award [1 max] for either $9.76 \times 10^{-3} \text{ mol dm}^{-3} \text{ s}^{-1}$ or $9.76 \times 10^{-5} \text{ mol dm}^{-3} \text{ s}^{-1}$.

3. (a) cobalt has a greater proportion of heavier isotopes / *OWTTE* / cobalt has greater number of neutrons; [1]

(b) 27 protons **and** 25 electrons; [1]

(c) $1s^2 2s^2 2p^6 3s^2 3p^6 3d^7$ / $[\text{Ar}] 3d^7$; [1]

(d) ^{60}Co / Co-60 /cobalt-60 **and** radiotherapy/sterilization of medical supplies/radiation treatment of food sterilizations/industrial radiography/density measurements in industry/(medical/radioactive) tracer;
Allow treatment of cancer.
Do not allow “just used in medicine”.

OR

^{57}Co / Co-57 /cobalt-57 **and** medical tests/label for vitamin B_{12} uptake; [1 max]
Do not allow “just used in medicine”.

4. (a) $(K_c =) \frac{[\text{CH}_3\text{OH}]}{[\text{CO}][\text{H}_2]^2}$; [1]

Do not award mark if incorrect brackets are used or brackets are missing.

(b) (i) amount (of methanol)/product decreases / less methanol;
(forward reaction) exothermic / reverse reaction endothermic / *OWTTE*; [2]

(ii) amount (of methanol)/product increases / more methanol;
3 gas molecules/mol \rightarrow 1 / decrease in volume / fewer gas molecules on right
hand side/products / more gas molecules on left hand side/reactants; [2]

(c) high pressure expensive / greater cost of operating at high pressure;
lower temperature – lower (reaction) rate; [2]

(d) increases rate of forward and reverse reactions (equally) / lowers activation energy/ E_a
(of both forward and reverse reaction equally) / provides alternative path with lower
activation energy/ E_a ; [1]

*Accept reactants adsorb onto the catalyst surface and bonds weaken resulting in a
decrease in activation energy.*

5. (a) vapour pressure ethoxyethane (81×10^3 Pa) > vapour pressure benzene (16×10^3 Pa) >
vapour pressure water (4×10^3 Pa);

*If three correct vapour pressure values related to each substance are stated alone
award M1.*

Allow range of $80\text{--}85 \times 10^3$ Pa, $14\text{--}18 \times 10^3$ Pa and $3\text{--}7 \times 10^3$ Pa.

Do not award mark for comparisons of just two substances.

water has hydrogen bonding;

benzene has van der Waals'/London/dispersion forces;

ethoxyethane has dipole–dipole forces (and van der Waals'/London/dispersion)

but they are weaker than benzene; [4]

(b) 81°C ; [1]

Allow $80\text{--}82^\circ\text{C}$.

SECTION B

6. (a) Award [2 max] for three of the following features:

Bonding

Graphite and C₆₀ fullerene: covalent bonds **and** van der Waals'/London/dispersion forces;

Diamond: covalent bonds (and van der Waals'/London/dispersion forces);

Delocalized electrons

Graphite and C₆₀ fullerene: delocalized electrons;

Diamond: no delocalized electrons;

Structure

Diamond: network/giant structure / macromolecular / three-dimensional structure **and** *Graphite:* layered structure / two-dimensional structure / planar;

C₆₀ fullerene: consists of molecules / spheres made of atoms arranged in hexagons/pentagons;

Bond angles

Graphite: 120° **and** *Diamond:* 109°;

C₆₀ fullerene: bond angles between 109–120°;

Allow Graphite: sp² **and** *Diamond:* sp³.

Allow C₆₀ fullerene: sp² **and** sp³.

Number of atoms each carbon is bonded to

Graphite and C₆₀ fullerene: each C atom attached to 3 others;

Diamond: each C atom attached to 4 atoms / tetrahedral arrangement of C (atoms); [6 max]

- (b) (i) network/giant structure / macromolecular;
each Si bonded covalently to 4 oxygen atoms **and** each O atom bonded covalently to 2 Si atoms / single covalent bonds; [2]
Award [1 max] for answers such as network-covalent, giant-covalent or macromolecular-covalent.
Both M1 and M2 can be scored by a suitable diagram.
- (ii) *Silicon dioxide:* strong/covalent bonds in network/giant structure/macromolecule;
Carbon dioxide: weak/van der Waals'/dispersion/London forces between molecules; [2]
- (c) triple (covalent) bond;
one electron pair donated by oxygen to carbon atom / dative (covalent)/coordinate (covalent) bond; [2]
Award [1 max] for representation of C≡O.
Award [2] if CO shown with dative covalent bond.

- (d) delocalization/spread of pi/ π electrons over more than two nuclei;
 equal bond order/strength/length / spreading charge (equally) over all three oxygens;
 gives carbonate ion a greater stability/lower potential energy; [3]
M3 can be scored independently.
Accept suitable labelled diagrams for M1 and M2 e.g.

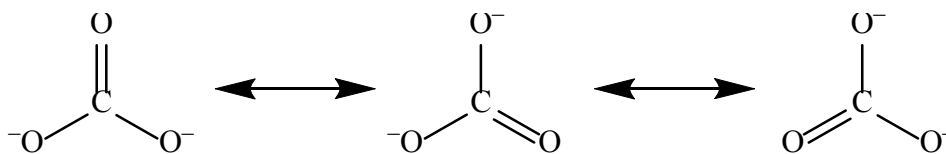

OR

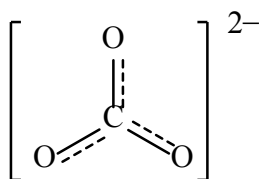

Do not penalize missing brackets on resonance structure but 2- charge must be shown.

Allow -2 for charge on resonance structure.

- (e) mixing/combining/merging of (atomic) orbitals to form new orbitals (for bonding);
Allow molecular or hybrid instead of new.
Do not allow answers such as changing shape/symmetries of atomic orbitals.

Carbon dioxide: sp;

Diamond: sp³;

Graphite: sp²;

Carbonate ion: sp²; [5]

- (f) (i) *Molten sodium oxide:* conducts because of free moving/mobile ions in molten state;
Sulfur trioxide: doesn't conduct because no free moving/mobile charged particles/it has neutral molecules; [2]
Award [1 max] for stating molten sodium oxide conducts but sulfur trioxide doesn't.
Do not award M2 for "just sulfur trioxide does not conduct because it is molecular."

(ii) $\text{Na}_2\text{O}(\text{s}) + \text{H}_2\text{O}(\text{l}) \rightarrow 2\text{NaOH}(\text{aq});$

$\text{SO}_3(\text{l}) + \text{H}_2\text{O}(\text{l}) \rightarrow \text{H}_2\text{SO}_4(\text{aq});$

both solutions conduct;

Ignore state symbols. [3]

7. (a)

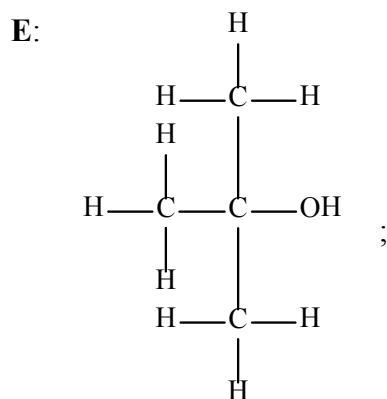
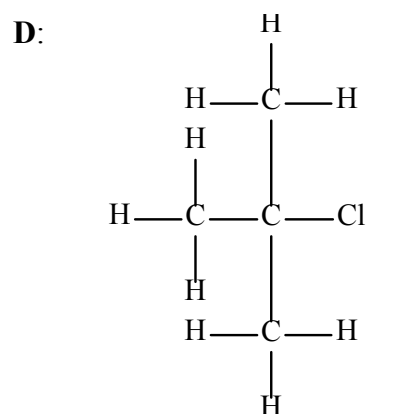
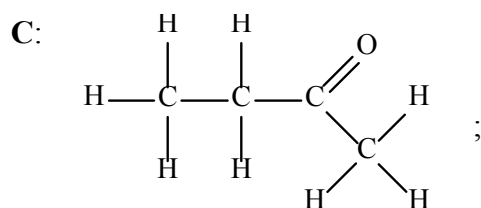
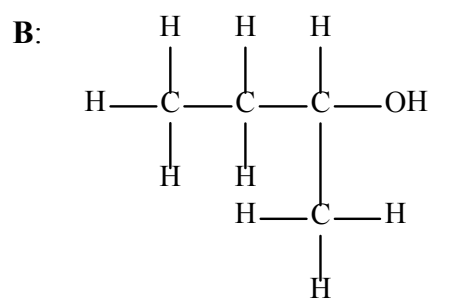
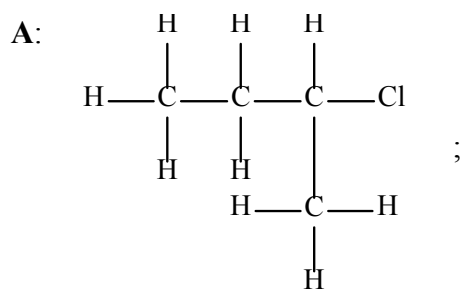

Accept condensed formulas.

Award [1 max] if **A** and **D** are other way round (and nothing else correct).

Award [2 max] if **A** and **D** are other way round but one substitution product **B** or **E** is correct based on initial choice of **A** and **D**.

Award [3 max] if **A** and **D** are other way round but both substitution products **B** and **E** are correct based on initial choice of **A** and **D**.

M2 (for **B**) and M5 (for **E**) may also be scored for substitution product if primary chloroalkane used.

Penalize missing hydrogens once only in Q.7.

[5]

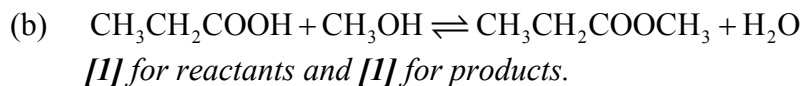

(concentrated) sulfuric acid/ H_2SO_4 ;
 Do not accept just H^+ or acid.

methyl propanoate;

[4]

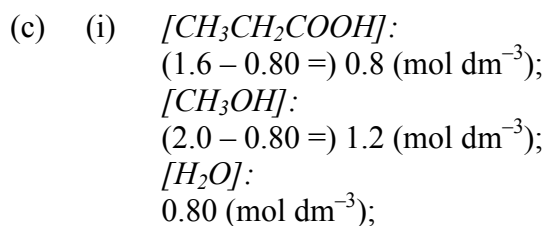

[3]

(ii) $(K_c =) \frac{[\text{CH}_3\text{CH}_2\text{COOCH}_3] [\text{H}_2\text{O}]}{[\text{CH}_3\text{CH}_2\text{COOH}] [\text{CH}_3\text{OH}]}$;

$(K_c =) \frac{[(0.80)^2]}{[(1.2 \times 0.8)]} = 0.7$;

[2]

Allow 0.67.

Award [1 max] for 0.83.

(d) (i)

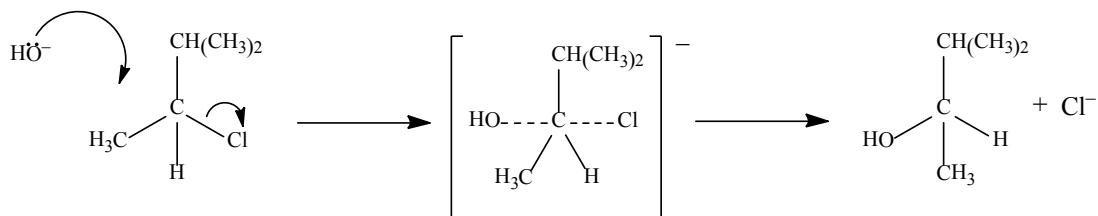

curly arrow going from lone pair/negative charge on O in HO^- to C;
 Do not allow curly arrow originating on H in HO^- .

curly arrow showing Cl leaving;

Accept curly arrow either going from bond between C and Cl to Cl in 2-chloro-3-methylbutane or in the transition state.

representation of transition state showing negative charge, square brackets and partial bonds;

Do not penalize if HO and Cl are not at 180° to each other.

Do not award M3 if OH ---- C bond is represented.

formation of organic product 3-methylbutan-2-ol and Cl^- ;

[4]

(ii) OH^- has a negative charge/higher electron density;
greater attraction to the carbon atom (with the partial positive charge) / *OWTTE*; [2]
Do not allow just greater attraction.

(iii) $\text{CH}_3\text{CH}_2\text{CH}_2\text{CH}_2\text{Cl} + \text{KCN} \rightarrow \text{CH}_3\text{CH}_2\text{CH}_2\text{CH}_2\text{CN} + \text{KCl}$;
Accept CN for KCN and Cl for KCl.

pentanenitrile;
Allow 1-cyanobutane.

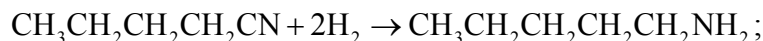

pentan-1-amine / 1-aminopentane / 1-pentylamine / 1-pentanamine;
Catalyst: nickel/Ni / palladium/Pd / platinum/Pt; [5]
Penalise missing hydrogen once only in Q.7.

8. (a) (i) *Acid: proton/ H^+ donor and Base: proton/ H^+ acceptor;*
Do not accept OH^- for base.

Weak base: (base/electrolyte) partially dissociated/ionized (in solution/water)
and *Strong base: (base/electrolyte assumed to be almost) completely/100%*
dissociated/ionized (in solution/water) / OWTTE;

NH_3 / $\text{CH}_3\text{CH}_2\text{NH}_2$;

Allow either name or formula or other suitable example. [3]

(ii) sulfurous acid/ H_2SO_3 ;
corrodes marble/limestone buildings/statues / leaching in soils / harms/kills
plants;

OR

nitrous acid/ HNO_2 ;

corrodes marble/limestone buildings/statues / leaching in soils / harms/kills
plants;

OR

carbonic acid/ H_2CO_3 ;

corrodes marble/limestone buildings/statues / acidification of lakes;

[2]

Do not allow oxides (e.g. CO_2 etc.).

Do not accept just corrodes or damages.

(iii) *Volume of KOH: 20 (cm^3);*
Allow any value between 20 and 21 (cm^3).

pH at the equivalence point: 8.0–10.0;

[2]

(iv) At half-equivalence point $[\text{CH}_3\text{COOH}] = [\text{CH}_3\text{COO}^-]$ so $\text{pH} = \text{p}K_a$;

$\text{p}K_a = 4.7$;

Accept in range 4.2 to 5.2.

*M2 can only be scored if M1 correct (i.e. no marks for just Data Booklet value
of 4.76).* [2]

(v)

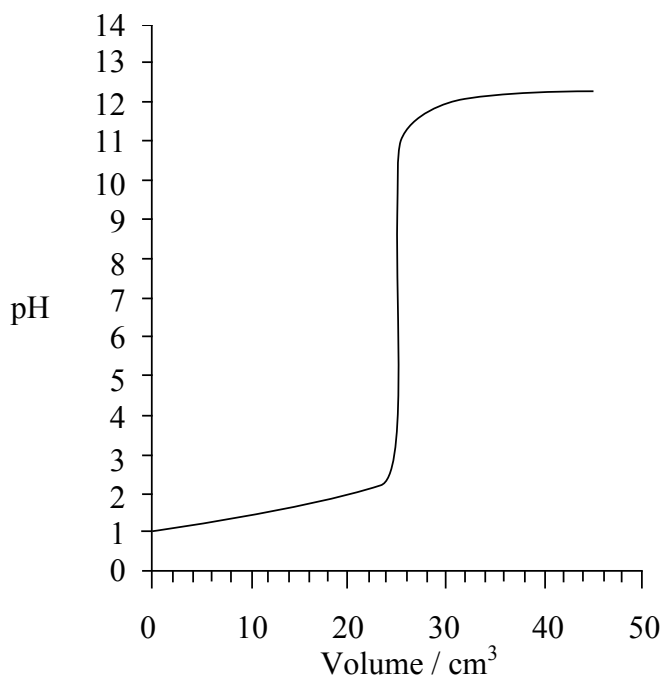

Starting pH: 1;

Equivalence point: pH = 7 and 25 cm³;

Final pH reached: 12–13;

correct curve shape;

Do not award M4 if turn in curve is seen at low volumes (suggesting weak acid–strong base titration).

Award [4] if values corresponding to M1, M2 and M3 are labelled on graph (e.g using X) and correct shape of curve shown.

[4]

(b) (i) HIn is a weak acid / weak base;

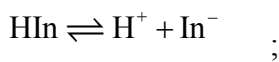

colour 1 colour 2

\rightleftharpoons required.

Award [2] for M2 alone.

in base equilibrium moves to right / in acid equilibrium moves to left;

[3]

(ii) phenolphthalein;

indicator colour change occurs in range of pH at the equivalence point / OWTTE;

M2 can be scored independently even if indicator is incorrect.

[2]

(c) acidic;

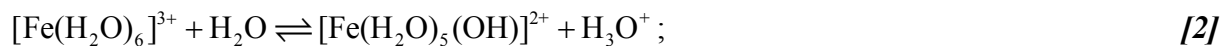
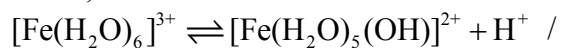

Accept equations indicating the formation of

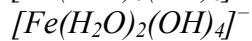
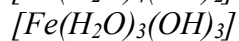
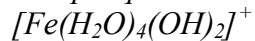

Do not penalize \rightarrow .

(d) $n(\text{HCl}) = (0.100 \times 0.50) = 0.050$ (mol);

$n(\text{NaOH}) = (0.200 \times 0.10) = 0.020$ (mol);

$n(\text{HCl})_{\text{remaining}} = (0.050 - 0.020) = 0.030$ (mol);

$$[\text{HCl}] = \left(\frac{0.030}{0.30} \right) = 0.10 \text{ (mol dm}^{-3}\text{)};$$

pH = 1.0;

Award [2 max] for just pH = 1.0 without working.

[5]

9. (a) (i)

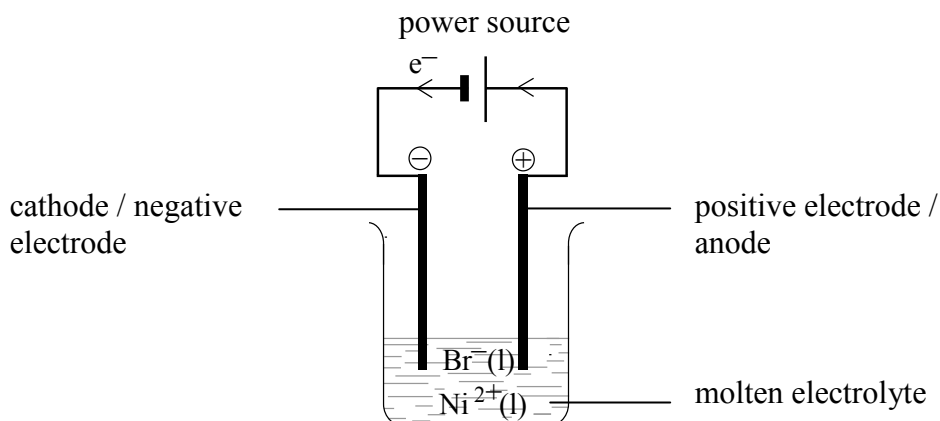

labelled polarities of positive **and** negative electrodes;
Electrodes can be labelled positive or negative or + and - signs can be used.

direction of electron flow;
e⁻ does not have to be labelled but arrow essential.

power source **and** molten electrolyte/Ni²⁺ (l) **and** Br⁻ (l)/NiBr₂ (l);
*State symbol necessary for M3 unless molten electrolyte stated.
 Power source does not need to be labelled if correct symbol used (i.e. short line and long line).*

Cathode/negative electrode equation:

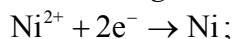

Anode/positive electrode equation:



[5]

Accept balanced half-equation with one e⁻.

Award [1 max] for M4 and M5 if electrodes are not identified or if equations are given wrong way round or incorrectly labelled.

Penalize ⇌ once only in Q.9.

Allow e instead of e⁻.

Ignore state symbols for M4 and M5.

(ii) *Dilute sodium chloride:*



Concentrated sodium chloride:



[2]

Accept alternative balanced half-equations with correct number of electrons.

Award [1 max] if equations are given the wrong way round.

Award [2] if correct equations are written in order with dilute sodium chloride first and concentrated sodium chloride second but processes not stated explicitly.

Penalize ⇌ once only in Q.9.

Allow e instead of e⁻.

Ignore state symbols.

- (b) (i) $\text{Sn} + \text{Cu}^{2+} \rightarrow \text{Sn}^{2+} + \text{Cu}$; [1]
Ignore state symbols.
Penalize \rightleftharpoons once only in Q.9.
- (ii) $(0.34 - -0.14) = (+) 0.48 \text{ V}$; [1]
- (iii) 1.0 mol dm^{-3} solutions **and** $25^\circ\text{C}/298 \text{ K}$; [1]
- (c) Cd^{2+} is a stronger oxidizing agent than H_2O **and** will be displaced to produce Cd /
OWTTE;
 Cr^{2+} is a weaker oxidizing agent than H_2O **and** H_2 will displace in preference to Cr /
OWTTE; [2]
*Award [1 max] for stating Cd^{2+} stronger oxidizing agent than H_2O **and** Cr^{2+} weaker oxidizing agent than H_2O / OWTTE.*
- (d) (i) Ni;
 only requires 2 mol of e^- for each mol of Ni / Sn requires 4 mol of e^- /
 Cr requires 3 mol of e^- / Ni^{2+} needs least number of e^- to produce 1 mol of Ni
 metal;
Allow e instead of e^- .
- cathode / negative electrode; [3]
Do not award M3 for "metal deposited at cathode where oxidation occurs".
- (ii) temperature of solution;
 $[\text{Sn}^{4+}]$;
 surface area/size of electrode;
 material of electrodes; [2 max]
Do not allow nature of electrodes.

- (e) (i) NH_3 : -3;
 NO : +2;
 N_2 : 0; [3]
Penalize incorrect notation such as 3-, III, 2+, 2, II once only.
- (ii) *Oxidation:*
 $2NH_3 \rightarrow N_2 + 6H^+ + 6e^-$;
Reduction:
 $2NO + 4H^+ + 4e^- \rightarrow N_2 + 2H_2O$;
Award [1 max] for M1 and M2 if redox processes are not identified or if equations are given wrong way round.
Penalize \rightleftharpoons once only in Q.9.
Allow e instead of e^- .
Ignore state symbols.
- Oxidizing agent: NO;* [3]
Allow either formula or name.
- (iii) NH_3 /ammonia (in excess by) **and** 10 (dm³);
25.0 (dm³); [2]
-