



SAMPLE A

Diploma Programme subject in which this extended essay is registered: Chemistry
(For an extended essay in the area of languages, state the language and whether it is group 1 or group 2.)

Title of the extended essay: Investigation of the lipase inhibitor
Orlistat on 1% lipase acting on full cream milk

Candidate's declaration

If this declaration is not signed by the candidate the extended essay will not be assessed.

The extended essay I am submitting is my own work (apart from guidance allowed by the International Baccalaureate).

I have acknowledged each use of the words, graphics or ideas of another person, whether written, oral or visual.

I am aware that the word limit for all extended essays is 4000 words and that examiners are not required to read beyond this limit.

This is the final version of my extended essay.

Candidate's signature: _____

Date: 06 FEB 2009

IB Cardiff use only:

A: 44736 B: ✓

Supervisor's report

The supervisor must complete the report below and then give the final version of the extended essay, with this cover attached, to the Diploma Programme coordinator. The supervisor must sign this report; otherwise the extended essay will not be assessed and may be returned to the school.

Name of supervisor (CAPITAL letters) _____

Comments

Please comment, as appropriate, on the candidate's performance, the context in which the candidate undertook the research for the extended essay, any difficulties encountered and how these were overcome (see page 13 of the extended essay guide). The concluding interview (viva voce) may provide useful information. These comments can help the examiner award a level for criterion K (holistic judgment). Do not comment on any adverse personal circumstances that may have affected the candidate. If the amount of time spent with the candidate was zero, you must explain this, in particular how it was then possible to authenticate the essay as the candidate's own work. You may attach an additional sheet if there is insufficient space here.

worked with great interest on this topic. He obtained the
Orlistat from the USA as he was unable to acquire it in Singapore
and spent a great deal of time researching the effects of diet pills on
the body. major problems were that we had not started
the kinetics topic by the time he finished his EE and that his results
were not producing the graph he expected. As you can see he collected
vast number of results which he manipulated in many different
ways to come up with one that made sense to him.

I have read the final version of the extended essay that will be submitted to the examiner.

To the best of my knowledge, the extended essay is the authentic work of the candidate.

I spent hours with the candidate discussing the progress of the extended essay.

Supervisor's signature: _____

Date: 6/2/2009

0

**Investigation of the lipase inhibitor Orlistat on 1%
lipase acting on full cream milk**

Session: May 2009

Candidate Name:

Candidate Number:

IB Subject of Essay: Chemistry

Research Question: “In the presence of 1% lipase and full cream milk, how does Orlistat (a lipase inhibitor) affect the enzyme?”

Supervisor Name:

Word Count: 3989 ✓

Abstract

Obesity is increasingly becoming a major cause for concern. The World Health Organization predicts that around 2 billion people will be either overweight or obese by the year 2015. To combat obesity, doctors use a range of techniques, including prescribing diet pills.

Orlistat is a type of diet pill that inhibits the enzyme lipase from catalyzing the breakdown of lipids into fatty acids in the small intestine. This essay looks at the type of inhibition Orlistat uses on lipase. The research question is **“In the presence of 1% lipase and full cream milk, how does Orlistat (a lipase inhibitor) affect the enzyme?”**

In order to answer this question, the concept of a V_{max} curve was adopted from the topic of enzyme kinetics in Biochemistry. The theory suggests that different types of enzyme inhibition can change the V_{max} curve from an un-inhibited reaction.

I observed and compared the reaction between the enzyme and ten different arbitrary concentrations (between 10% and 100%) of full cream milk. The reaction causes the pH of the solution to drop. This is due to a higher concentration of hydrogen ions in a solution with more fatty acid molecules than lipid molecules. Using this theory, I raised the pH of each concentration of full cream milk up to pH10.00 using Na_2CO_3 . After which I added 1% lipase solution using either 0mg, 60mg or 120mg Orlistat solution. I observed and calculated the rate of pH change between a set interval of pH9.5 and pH8.5 for each concentration.

The V_{max} values for 0mg, 60mg and 120mg were different. The 0mg Orlistat sample reached 0.00739 ± 0.0003 pH/sec whilst the 60mg Orlistat sample reached 0.00395 ± 0.0002 pH/sec and the 120mg Orlistat sample reached 0.00369 ± 0.0001 pH/sec. This allowed me to draw a conclusion that Orlistat inhibits Lipase through reversible (non-competitive) type inhibition.

Word Count: 298

Table of Contents

INTRODUCTION:	4
<u>APPROACH TO RESEARCH QUESTION:</u>	5
BACKGROUND INFORMATION:	7
VARIABLES	12
APPARATUS:	13
<u>REQUIRED TO CALIBRATE PH-SENSOR AND FOR DATA COLLECTION:</u>	13
<u>REQUIRED TO PREPARE SOLUTIONS FOR EXPERIMENT:</u>	13
<u>REQUIRED FOR EXPERIMENT:</u>	14
METHOD:	15
<u>MAKING SOLUTIONS:</u>	15
<u>EXPERIMENT</u>	16
EVIDENCE:	17
<u>QUANTITATIVE:</u>	17
<u>QUALITATIVE:</u>	17
ANALYSIS:	18
<u>PROCESSING DATA INSTRUCTIONS:</u>	18
<u>ADDITIONAL CALCULATIONS:</u>	20
<i>Averages:</i>	20
<i>Errors:</i>	20
CONCLUSION:	21
<u>FURTHER QUESTIONS:</u>	21
EVALUATION:	22
<u>EXPERIMENTAL ERRORS:</u>	22
<u>ASSUMPTIONS AND ADDITIONAL CONSIDERATIONS:</u>	23
BIBLIOGRAPHY	24
APPENDICES:	25

Introduction:

My research plans to investigate the maximum velocity (V_{max}) at which 1% lipase solution can break down lipids into fatty acids, and the effect of the lipase inhibitor Orlistat on this velocity. This is determined by the type (reversible or irreversible (competitive, non-competitive, uncompetitive)) of enzymic inhibition that takes place. My research question is as follows:

“In the presence of 1% lipase and full cream milk, how does Orlistat (a lipase inhibitor) affect the enzyme?”

V_{max} is the rate at which the enzyme is fully saturated with the substrate. An enzyme is fully saturated with substrate when all of the enzymes in a solution have their active sites in use by the substrates in that solution and hence reached the maximum rate. By conducting this experiment, I will also be able to determine whether Orlistat is an irreversible or reversible inhibitor. If it is reversible, I will be able to determine if it is a competitive or non-competitive inhibitor. Distinguishing the type of inhibition will be achieved by observing the trend in the curve of concentration of substrate against rate. Fig 1.1 clearly shows the difference in shape and V_{max} of a reaction without an inhibitor, with a competitive inhibitor or with a non-competitive inhibitor.

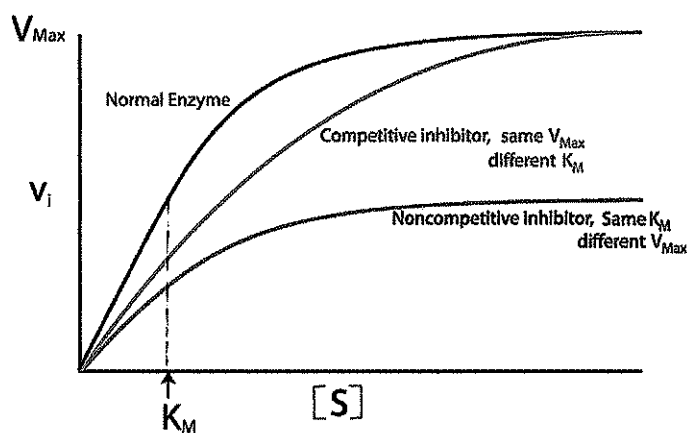

Fig. 1.1: A graph to show the differences in the shape of the normal enzyme, competitive inhibitor and noncompetitive inhibitor curves in a plot of substrate concentration against rate. K_m is the Michaelis Constant and represents half of the maximum rate.

When I carry out my experiment, I will obtain a graph that looks similar to Fig 1.1. I intend to use the different curves I find on these graphs to work out what type of enzymic inhibition Orlistat uses. If I find curves that reach the same V_{max} , then Orlistat uses competitive inhibition. If I find curves that do not reach the same V_{max} , then Orlistat uses non-competitive inhibition.

¹ University of New England. <http://faculty.une.edu/com/courses/bionut/distbio/obj-512/Chap9-enzymeinhibition.gif> (Last Accessed: 5th Oct 2008)

Approach to Research Question:

I selected this research question because I wanted to investigate the behavior of Orlistat, and determine the type of inhibition that takes place when that drug is used. In order to answer my research question, I devised a method that would allow different V_{max} curves to be determined. I used three samples, one with no Orlistat, a second with 60mg Orlistat and the last with 120mg Orlistat in solution. I have selected 60mg Orlistat and 120mg Orlistat because Orlistat is marketed under two main brands: Xenical which contains 120mg Orlistat and is sold on a prescription only basis and Alli which contains 60mg Orlistat and is sold on an over-the-counter basis in the United States.

Each sample was tested with 5cm^3 1% Lipase Solution and 5cm^3 full cream milk at different concentrations made up to pH 10.00 by the addition of $0.1\text{mol Na}_2\text{CO}_3$. The full cream milk at different concentrations is made up to pH 10.00 as the product, when formed, will lower this pH. This is the say that when lipase (enzyme) and lipids (substrate) interact, fatty acids (product) will form (Fig. 1.2). Fatty acids have a higher concentration of hydrogen ions, which decreases the pH of the entire solution.

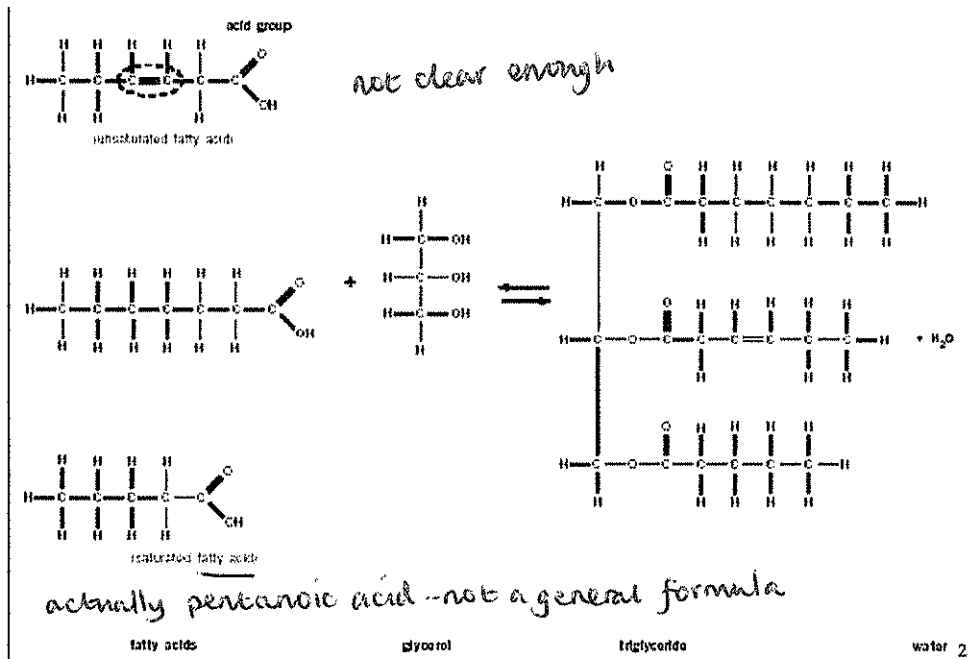

Fig. 1.2: This diagram shows chemical equations where a triglyceride (lipid) can react to form different fatty acids and glycerol. *actually it is shown the other way round!*

When all three of the samples (0mg, 60mg and 120mg Orlistat) have their curves compared, it will be possible to determine the type of inhibition that takes place. If it is competitive inhibition, the same V_{max} will be achieved, although the time taken to achieve that V_{max} will differ. The same V_{max} can be achieved here because "you can always keep increasing the substrate concentration until the amount of inhibitor can't

² Chris Watters. <http://www.biologyreference.com/La-Ma/Lipids.html> (Last Accessed: 5th Oct 2008)

effectively compete, it's as if there were no inhibitor present".³ With this in mind, the same V_{\max} can be reached once all of the enzymes are saturated with substrate, and the effect of the inhibitor is negligible.

If it is non-competitive inhibition then a lower V_{\max} will occur (as seen in Fig. 1.1). This is due to those enzyme molecules that are not affected by the inhibitor still responding to the substrate normally.⁴ This is also why the K_m (Michaelis Constant) is the same as the un-inhibited reaction.

With molarity of lipids within the milk unknown, I devised a different method for calculating the concentration of lipids (substrate). I used arbitrary units, and diluted the original full cream milk into nine different concentrations of solutions. The 100% full cream milk (and hence the highest amount of substrate possible) was given the arbitrary value of 1.0. The 90% full cream milk (90% of the substrate is present) was given the arbitrary value of 0.9. The 80% full cream milk was given the value of 0.8, and so on, until the 10% full cream milk sample, which was given the value of 0.1. By doing this, I was able to create a graph where I should be able to find curves that can determine V_{\max} , so long as V_{\max} exists within one arbitrary concentration of full cream milk.

³ Chasin. Columbia University.
<http://cubweb.biology.columbia.edu/introbio/faq/disp.php?idval=138&classid=1>(Last Accessed: 5th Oct 2008)

⁴ Chasin. Columbia University.
<http://cubweb.biology.columbia.edu/introbio/faq/disp.php?idval=137&classid=1>(Last Accessed: 5th Oct 2008)

Background Information:

An enzyme is a protein molecule that acts as a biological catalyst. Essentially, enzymes are used to speed up chemical reactions that occur in living organisms. Similar to inorganic catalysts, enzymes (E) provide an alternate pathway for the reaction, thus lowering the activation energy required for certain reactions to take place (Fig. 1.3 and Fig. 1.4).⁵ Additionally, as a catalyst, they are not used up during the reaction they are catalyzing.

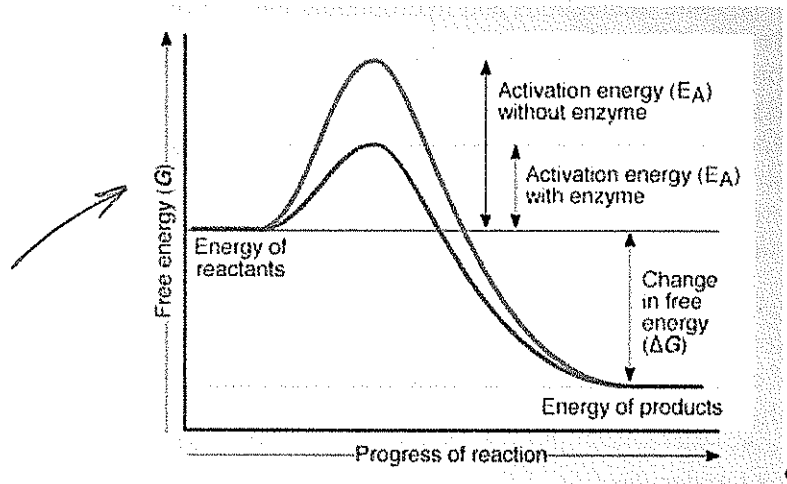

Fig. 1.3: A Graph to Show an Enzyme's Effect on Activation Energy for Reactions

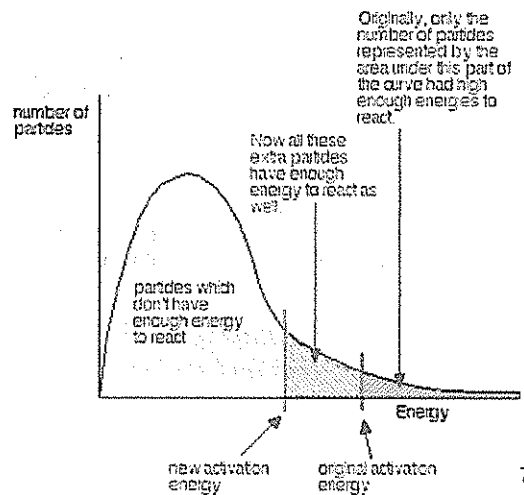

Fig. 1.4: This Maxwell-Boltzmann Distribution shows how, the enzyme has shifted the activation energy required from the original activation energy to the new activation energy. This shows how more particles now have enough energy to react.

⁵ John Green, S. Damji, *Chemistry* (Victoria: IBID Press, 2007) 330 (Last Accessed: 5th Oct 2008)

⁶ Thompson Learning Inc. <http://www.dwm.ks.edu.tw/bio/activelearner/06/ch6c1.html> (Last Accessed: 5th Oct 2008)

⁷ Jim Clark. <http://www.chemguide.co.uk/physical/basicrates/catalyst.html> (Last Accessed: 5th Oct 2008)

validity?

Enzymes are highly specific as they carry out the function of increasing the rate at which a certain substrate (S) is converted into its product (P). The rate at which this would happen without an enzyme is significantly slower as enzymes typically increase the rate of reactions by “factors of 10^6 - 10^{12} compared to the uncatalysed reaction”⁸. This difference in rate is due to the enormous catalytic power of enzymes. Enzymes help to convert the energy of the substrate into the energy of the product with high efficiency⁹. When an enzyme is introduced into a solution of the specific substrate, the substrate binds into what is known as the active site of the enzyme by hydrogen bonds, ionic interactions and hydrophobic interactions. This is achieved by the enzyme re-orientating the substrate into an “optimal orientation, the prelude to making and breaking chemical bonds.”¹⁰ This forms the Enzyme-Substrate Complex (E + S → ES).¹¹ The active site takes up a small volume of the total volume of an enzyme. It should be noted that an enzyme has a three-dimensional shape; hence the active site can be thought of as a cleft or crevice.¹² Enzymes exist with tertiary or quaternary protein structures. An enzymes shape is determined by its many interactions such as covalent bonding, hydrogen bonding, salt bridges and disulphide bridges.

not that recent!

Recent research suggests the “Induced Fit Theory” which is based on the idea that the active sites of enzymes are slightly less rigid than once thought in the “Lock and Key” mechanism (Fig. 1.5).¹³ The “Induced Fit Theory” proposes that enzymes are not solely specific to one certain substrate, but could possibly mold its active site around similarly shaped molecules (Fig. 1.6).

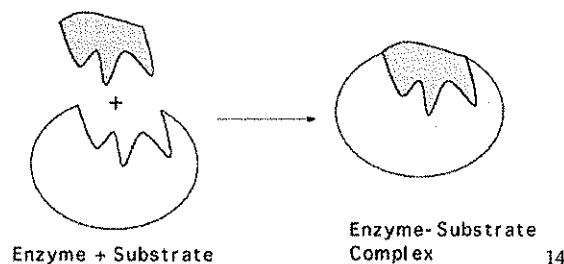

Fig. 1.5: A Diagram to show the formation of the Enzyme-Substrate (ES) Complex in the ‘lock and key’ model

⁸ Richard Harwood, *Biochemistry* (New York: Cambridge UP, 2002) 24

⁹ Lubert Stryer *Biochemistry* (Boston: W. H. Freeman & Company) 184

¹⁰ Stryer 184

¹¹ J. Kimball. <http://users.rcn.com/jkimball.ma.ultranet/BiologyPages/E/Enzymes.html> (Last Accessed: 5th Oct 2008)

¹² Stryer 190

¹³ Charles E Ophardt. <http://www.elmhurst.edu/~chm/vchembook/571lockkey.html> (Last Accessed: 5th Oct 2008)

¹⁴ Washington University in St. Louis -

<http://www.chemistry.wustl.edu/~edudev/LabTutorials/Carboxypeptidase/images/lockkey.jpg> (Last Accessed: 5th Oct 2008)

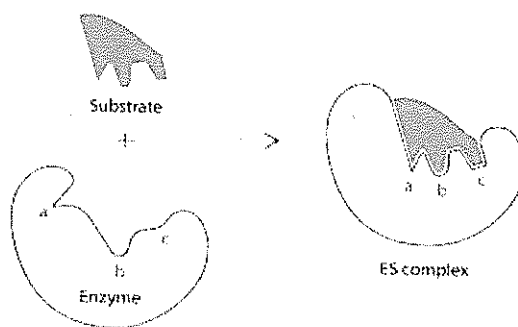

Fig. 1.6: A Diagram to show the formation of the Enzyme-Substrate (ES) Complex in the 'Induced-fit' model

When an enzyme is introduced to its specific substrate, the enzyme will catalyze the reaction at a changing rate dependent upon several factors. These factors include the surrounding temperature, pH level, concentration of the enzymes, or the concentration of the substrate. Temperature is important as enzymes do not work as efficiently at lower temperatures than at its optimum temperature. However, they can also become permanently denatured at higher temperatures. If an enzyme is denatured, the shape of its active site changes due to bonds within the molecule breaking. Enzymes also operate at optimal pH levels. Vastly different pH levels can denature the enzyme by "altering its charge by altering the ionic bonds that contribute to its functional shape."¹⁵ At very high or low pH, and at high temperatures, the intramolecular bonds within the enzyme can break. At higher temperatures, an increase of atomic vibrations ruin these interactions. Extreme pH affects the enzyme by breaking salt bridges within the molecule.¹⁶ pH is determined by the concentration of hydrogen ions present. If there is a very high concentration of these ions, it is possible for them to interact with slightly negatively charged atoms on specific amino acids in an enzyme. If this takes place, the shape of the enzyme will change. The concentration of the enzyme is another key factor affecting the rate. If there is a higher concentration of enzymes the rate of the reaction should be higher as well.¹⁷ This is due to there being more enzyme molecules present which have a higher chance of interacting with the substrate molecules within a solution. A similar concept exists for explaining the importance of the concentration of substrate if the concentration of enzyme is constant. As the concentration of substrate increases, the rate of the reaction should also increase to a point where all the active sites in the enzyme molecules are in use. Once all active sites are in use, the maximum rate (V_{max}) has been reached. This means that all of the enzymes are catalyzing the reaction at the fastest rate possible. A higher V_{max} can be reached if more enzymes, and hence more active sites, are introduced.

¹⁵ Gary E Kaiser. <http://student.ccbcmd.edu/biotutorials/proteins/enzyme.html> (Last Accessed: 5th Oct 2008)

¹⁶ Naomi Boxall. <http://www.massey.ac.nz/~wwbioch/Prot/thirds/framset.htm> (Last Accessed: 5th Oct 2008)

¹⁷ Kaiser.

Many of the kinetic properties of enzymes can be explained through the Michaelis-Menten model.¹⁸ The following equation is relevant to my experiment:

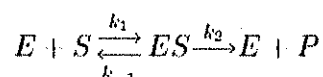

This model holds true where an enzyme and substrate combine to form the enzyme-substrate complex at the rate k_1 . The enzyme-substrate complex can then dissociate back into $E + S$ or can form $E + P$, where P is the product, at rates k_{-1} and k_2 respectively.¹⁹

In the human body, some enzymes are used to catalyze the break down of food molecules into smaller particles that can then be assimilated by the body. The enzyme that breaks down fats (lipids) into fatty acids is called lipase. Lipase is produced in the pancreas and is secreted into the duodenum of the intestine. Without lipase, the human body cannot process lipids, and the body cannot assimilate the nutrients found in fats.

Inhibitors act on enzymes to stop or slow down the rate at which they are converting their substrates into their respective products. There are two types of enzyme inhibitors, **irreversible** and **reversible** inhibitors.

Irreversible inhibitors permanently alter the shape of the molecule by forming covalent or strong non-covalent bonds with the amino acid and functional groups within an enzyme that are usually used for substrate binding or catalytic action.²⁰ Irreversible inhibitors may also contain functional groups that will react with the enzyme, such as aldehydes, alkenes or haloalkanes.²¹ When these functional groups react with parts of the enzyme, the shape of the enzyme will change. This causes the enzyme to be permanently inactive.

Reversible inhibitors can be classified as competitive, non-competitive or uncompetitive. Competitive inhibitors possess a similar shape to the substrate of an enzyme, and thus can compete for the active site of that enzyme. Once the competitive inhibitor has bonded to the active site of the enzyme through weak non-covalent bonds (such as Van Der Waal forces and hydrogen bonding), the substrate can no longer use that active site until the competitive inhibitor has been removed (Fig.1.7). Non-competitive inhibitors attach to the enzyme molecule somewhere other than the active site by weak non-covalent bonds. By doing so, the shape of the enzyme changes, and hence the shape of the active site also changes. The substrate can no longer bind into the active site (Fig. 1.8). In uncompetitive inhibition, the inhibitor only attaches to the enzyme once the enzyme-substrate complex has been created.²² Once it has interacted with the enzyme-substrate complex, it does not allow the products to form until it is removed. It should be emphasized that competitive, non-competitive and uncompetitive inhibitors attach to the enzyme molecule by weak interactions hence the ability to reverse such inhibition.

¹⁸ Boyer 137

¹⁹ Stryer 192

²⁰ Boyer 151

²¹ Lundblad R. L. *Chemical Reagents for Protein Modification* CRC Press Inc (2004)

²² Boyer 155

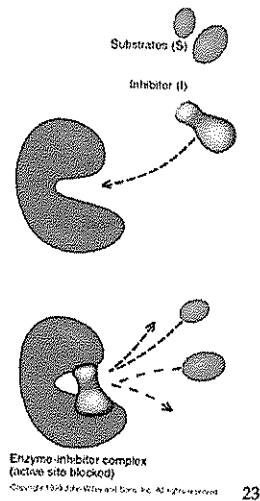

Fig. 1.7: A diagram showing how a competitive inhibitor binds to the active site of an enzyme to inhibit the substrates from entering that active site.

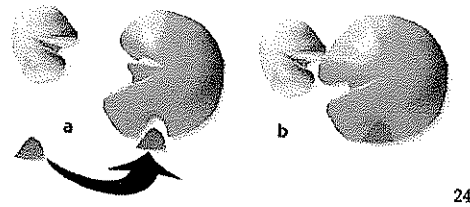

Fig. 1.8: A diagram showing how a non-competitive inhibitor binds to a separate part of the enzyme (not the active site), altering the shape of the enzyme and hence its active site. The substrate can no longer fit into this active site. The purple structure is the enzyme, the green structure is the substrate and the blue structure is the non-competitive inhibitor.

Much of this is on the human biochem opin of the course so is not really research!

The drug Orlistat (1-(3-hexyl-4-oxo-oxetan-2-yl)tridecan-2-yl 2-formylamino-4-methylpentanoate) is considered unique because it works to inhibit one quarter of the lipase present in the small intestine from working as catalysts that convert lipid into fatty acids.²⁵ Most other drugs used to combat obesity work as hunger suppressors or are involved in complex chemical changes in the brain.²⁶ It has been proven that Orlistat reduces the amount of lipids that are absorbed by the human body by 25%.²⁷

— Show structure & discuss

²³ John Wiley. http://fig.cox.miami.edu/~cmallery/255/255enz/competitive_inhibition.jpg (Last Accessed: 5th Oct 2008)

²⁴ Robert Stevenson. http://www.bio12.com/ch6/RemedialEnzymes_files/image007.jpg (Last Accessed: 5th Oct 2008)

²⁵ Omudhome Ogbru. <http://www.medicinenet.com/orlistat/article.htm> (Last Accessed: 5th Oct 2008)

²⁶ Xenical. http://www.xenical.com/xen_do_home.asp (Last Accessed: 5th Oct 2008)

²⁷ Omudhome Ogbru ?

Variables

Variable Type	Variable	How to Control or Measure this Variable
Independent	Time	Each test will be recorded over 900 seconds by the data logger used to collect the pH data.
Dependent	Change in pH	<i>Vernier</i> pH-sensor.
Control	Temperature	38°C is the temperature at which enzyme work at maximum capacity. Set the water bath to this temperature, and confirm with a separate thermometer.
	Type of Milk	Use the same brand/type of milk, make sure it is kept fresh by storing in a fridge at the appropriate temperature. This will ensure the milk does not expire and all of its ingredients are kept constant.
	Volume of Milk Used	10cm ³ to be used per boiling tube.
	Alkaline Solution to make each sample up to pH10.00	0.1M Na ₂ CO ₃ to be used.
	Type of Lipase	Porcine Lipase to be used
	Concentration of Lipase Solution	1% Lipase is to be used
	Type of Orlistat used	Make sure Xenical (120mg) and Alli (60mg) are used
	Temperature of Milk+Na ₂ CO ₃ solution	When determining the pH using a pH-sensor, make sure the solutions are at 38°C. <i>Vernier</i> pH-sensors are highly sensitive to temperature.

Apparatus:

Required to Calibrate pH-sensor and for Data Collection:

Apparatus/Materials	Quantity required for one test
pH 4.0 Buffer Solution	50cm ³
pH7.0 Buffer Solution	50cm ³
Vernier pH-sensor	1 (To speed up data collection, I used 4 pH-sensors, all calibrated using the same pH 4.0 and pH 7.0 buffer solutions) (with error +/- 0.02pH)
LabPro Data Logger	1
Laptop/Desktop computer with 'LoggerPro 3' software	1

Required to Prepare Solutions for Experiment:

Apparatus/Materials	Quantity required for one test
Distilled Water	A ready supply. Distilled Water is used throughout the experiment for dilutions and washing probes.
Porcine Pancreatic Lipase	5.0g
Mass Balance	1 (with error +/- 0.001)
Spatula	2
Glass Rod Stirrer	3 (to be washed with distilled water and dried after every use)
50cm ³ Burette	3 (with error +/- 0.1cm ³)
100cm ³ Beaker	30 (error is insignificant as beakers are used purely as a method of holding dilutions)
Funnel	3

Required for Experiment:

Apparatus/Materials	Quantity required for one test
Water Bath	1
Boiling Tube	10
Syringe	12 X 10cm ³ (with error +/-0.1cm ³)
Thermometer	1 (with error +/-0.25°C)

Method:

Making Solutions:

Several solutions were created before commencing the experiment. The first solution that was created was the 1% Lipase Solution. I used 1.000 +/- 0.001g Porcine Lipase powder and added this to 100cm³ distilled water by means of a burette to ensure accuracy.

The second set of solutions prepared was the different milk concentrations. As it is not possible for me to determine the molarity of milk, I decided to use arbitrary units method discussed in the *investigation* section of this essay. I created 10 different concentrations of milk by means of using two burettes and adding the milk and distilled water in different quantities in different beakers. The sample with 100% milk concentration was given the arbitrary value of 1.0. This means that the milk was not diluted. The sample with 90% milk concentration was given the arbitrary value of 0.9. To create this concentration I used a burette to measure 90cm³ milk and second burette to measure 10cm³ into a beaker. This method is continued for the arbitrary concentrations of 0.1 to 0.8 at every 0.1 interval. ✓

Create each separate concentration of milk at 38°C, or else a different pH value will occur during the experiment as pH-sensors are sensitive to temperature. Conducting this dilution in the water bath set at 38°C is recommended. Use a pH-sensor connected to a computer with a data logger to determine the pH of the milk. Add 0.1mol Na₂CO₃ to the milk solutions until the pH 10.00 +/- 0.02 has been reached. The error for a *Vernier* pH-Sensor is +/- 0.02 as stated on their probe's user manual.

Orlistat solutions must now be created. In samples with 0mg Orlistat, use 5cm³ of distilled water without anything dissolved in it. In the samples with 60mg of Orlistat, pour the contents of an Alli capsule into 100cm³ of distilled water. Mix the solution until the Orlistat dissolves. With the 120mg Orlistat, pour the contents of the Xenical capsule into 100cm³ of distilled water. In each test of 60mg or 120mg use 5cm³ of solutions created.

If more than one pH-sensor is used, they should be calibrated in order to ensure similar pH values are recorded. Calibrate the pH-sensors using pH-4 buffer solution and pH 7 buffer solution. This can be done by using the on screen instructions on the LoggerPro 3 software.

Experiment

- 1) Set up the experiment so that the water bath is at 38°C and has 10 boiling tubes in it.
- 2) In the 0mg Orlistat sample, insert 5cm³ full cream milk (with Na₂CO₃ at pH10.00) at 100% concentration using a syringe into a boiling tube.
 - a) For 60mg and 120mg Orlistat sample, insert 5cm³ inhibitor solution at this point.
- 3) Add 5cm³ lipase and finally insert the pH-sensor.
- 4) Start the data collection of pH change on the data logger.
- 5) Leave the pH-sensor to collect pH readings for 900 seconds.
- 6) Repeat this process with the nine remaining concentrations of full cream milk.
- 7) Repeat steps 1 to 6 with the 60mg and 120mg Orlistat. (Note, insert a step 2.a. whilst carrying out these tests)
- 8) In order to collect reliable data, repeat the entire experiment three times.

Evidence:

Quantitative:

Please view appendix one for the entire table of raw data that I have collected. It is imperative to note that the data shown here within the actual essay has all been processed from this raw data.

The appendices show the following tables (note: this is all quantitative data):

Table 1.1: A Table to show the changes in pH for each concentration, over three tests, with 0mg Orlistat present

Table 1.2: A Table to show the changes in pH for each concentration, over three tests, with 60mg Orlistat present

Table 1.3: A Table to show the changes in pH for each concentration, over three tests, with 120mg Orlistat present

Table 1.4: A Table to show the Average changes in pH for each concentration with no Orlistat present

Table 1.5: A Table to show the Average changes in pH for each concentration with 60mg Orlistat present

Table 1.6: A Table to show the Average changes in pH for each concentration with 60mg Orlistat present

Qualitative:

A Table to Show the Observations seen During the Experiment

Sample Type	Observation
0mg Orlistat	At the beginning of the experiment, the milk in the boiling tube had a cream colour, and after the experiment there was an oily looking substance just above the cream colour of the solution.
60mg Orlistat	The milky colour was observed at the beginning of each experiment. However, as the experiment progressed, a slightly thicker oily looking substance was formed just above the cream colour of the solution than in the 0mg sample. The cream colour was thicker with the 100% concentration sample and became progressively less thick with lower concentrations.
120mg Orlistat	In these tests, an oily looking substance was formed just above the cream colour of the solution. The cream colour was thicker with the 100% concentration sample and became progressively less thick with lower concentrations.

Analysis:

Please view appendix two for graphs that illustrate the following:

Graphs 1.1, 1.2 and 1.3 show comparisons of concentrations within each test of 0mg, 60mg and 120mg Orlistat.

Processing Data Instructions:

It can be noted that not all of the concentrations started at pH10.00, reasons for this will be discussed in the evaluation section. In order to proceed with processing the data with this in mind, the following method was adopted.

Observe the interval between pH 9.5 of the experiment and pH 8.5 (Graphs 2.1 to 2.3). I selected pH 9.5 and pH 8.5 because more samples run through both of these values. If the sample does not have a pH 9.5 value, take the starting pH value until it reaches pH 8.5. Additionally, if the sample does not reach pH 8.5, take the lowest pH value possible in the 900 seconds. Using the time taken for the pH to drop from pH 9.5 (or initial pH) to pH 8.5 (or the lowest possible pH above pH 8.5), the following equation was used for each different concentration:

$$\text{Rate of pH Change} = (\text{Change in pH})/(\text{time taken for pH to drop from pH 9.5 to pH 8.5 in sec})$$

In most cases where the sample passes through both pH 9.5 and pH 8.5, the equation can be simplified to:

$$\text{Rate of pH Change} = 1/(\text{time taken for the pH to drop from pH 9.5 to pH 8.5})$$

The following results were obtained:

Table 2.1: A Table to show the different rates of pH change in different arbitrary concentrations of full cream milk with 0mg, 60mg and 120mg Orlistat

Orlistat Present	Rate of pH Change at Different Arbitrary Concentrations (pH/sec) (+/- 4%)									
	0.1	0.2	0.3	0.4	0.5	0.6	0.7	0.8	0.9	1.0
0mg	0.01449	0.00833	0.00755	0.00667	0.01176	0.00741	0.00690	0.00690	0.00800	0.00426
60mg	0.00099	0.00472	0.00241	0.00385	0.00460	0.00400	0.00588	0.00417	0.00229	0.00364
120mg	0.00500	0.01429	0.00625	0.00588	0.00264	0.00261	0.00263	0.00299	0.00259	0.00260

Graph 3.1:

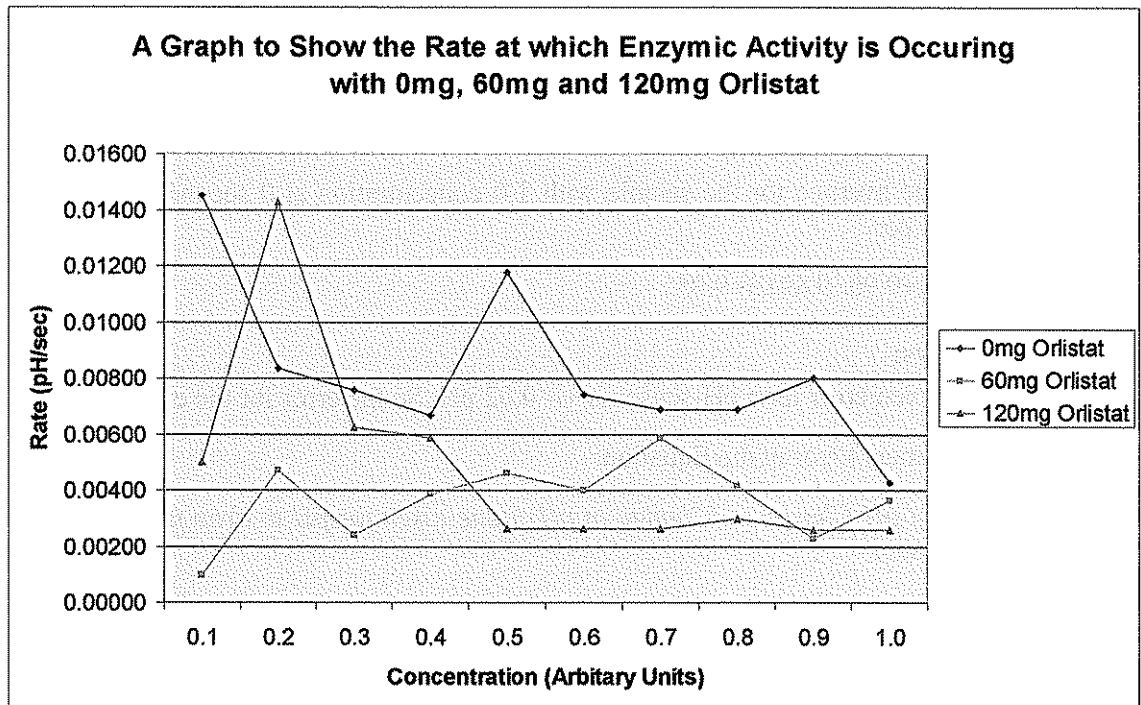

Now plot the V_{max} line for each set of values.

Graph 3.2:

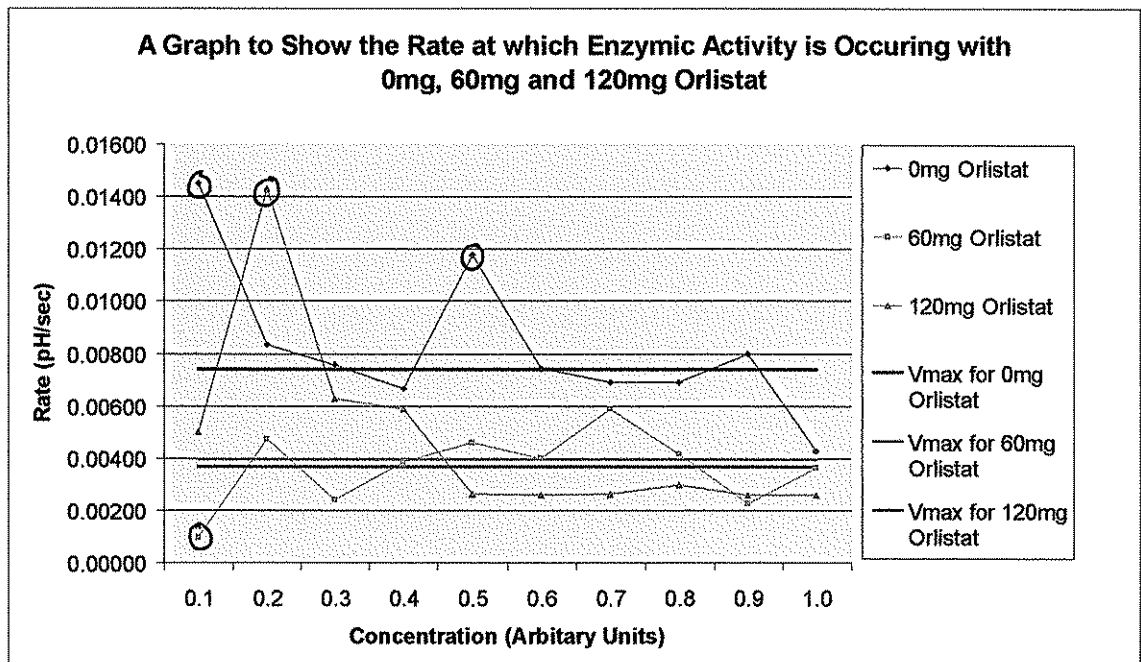

Note: Anomalies are circled.

Additional Calculations:

Averages:

To calculate an average you must do the following:

Average = (sum of variables from different tests)/(number of tests)

i.e. The average for the sample with 1.0 concentration at 0 seconds with no orlistat would be:

$$(10.00+9.96+9.89)/3=9.95$$

Errors:

The given error for a pH-sensor is +/- 0.02 pH. So the error for the experiment is:

Percentage Error in the Equation:

Rate of pH Change = (Change in pH)/(time taken for pH to drop from pH 9.5 to pH 8.5 in sec)

Would be the two pH values $(0.02 + 0.02) = 0.04$. Then $0.04/1 \times 100 = 4\%$.

The error in the time (in sec) is negligible as time values were collected a data logging program on a computer. Therefore the overall error of each rate would be 4%.

Conclusion:

This experiment has shown both signs of success and weaknesses. However, when it comes to results, I have several interesting observations to report.

I was only able to approximate where V_{\max} should lie by making an assumption that, perhaps V_{\max} had already been reached by the arbitrary concentration 0.1. This is a valid assumption, as once anomalies have been taken into consideration the data shows fluctuation around the same rates. For this reason I have drawn trend lines as to where I think V_{\max} should be. These lines look different to those seen in Fig. 1.1 in the *introduction* section. In order to create a graph like Fig 1.1, I will have to look at concentrations below arbitrary concentration 0.1.

As discussed in the *Errors* section of *Additional Calculations*, the random error for my experiment is 4% of whatever the rate is.

By using these V_{\max} values, it is still possible for me to answer my research question. Graph 3.2 (pg 18) shows the rates of the 0mg, 60mg and 120mg samples at each concentration. The trend lines on the graph suggest that the 0mg sample has a faster rate of reaction than the 60mg, which has a faster rate than the 120mg sample. This is to say that 0mg has the highest V_{\max} at 0.00739 ± 0.0003 pH/sec, 60mg has the second highest V_{\max} at 0.00395 ± 0.0002 pH/sec and 120mg has the slowest V_{\max} at 0.00367 ± 0.0001 pH/sec. **Due to each V_{\max} being different, it is reasonable, then, to suggest that Orlistat binds to lipase using non-competitive inhibition.** This is due to non-competitive inhibition affecting enzymes by changing their final V_{\max} value, and hence each 0mg, 60mg and 120mg curve not tending towards the same V_{\max} .

Further Question:

An unresolved question that should be addressed is how would the rate of pH change be different at lower concentrations than 0.1 arbitrary concentration. The reason why this would be interesting is because it may verify my assumption. This is to see whether all of the observed rates at concentrations above 0.1 arbitrary concentration are really just fluctuating around where the V_{\max} should be.

Evaluation:

My assumption that different concentrations of substrate have an effect on the rate of enzymic activity was proven. However, the experiment could be strengthened by considering the following:

Experimental Errors:

Errors have affected the results of my experiment and contributed to anomalies in my data. The random errors that have occurred does, in small part, explain why a V_{\max} curve is not more clearly visible. If I were to do the experiment again I would take the following into consideration:

Error	Description
More than one probe was used.	Use only one pH-sensor. During my experiment I used four pH-sensors, to drastically reduce the amount of time it would take for three tests to take place. However, even though the four pH-sensors were calibrated identically, they displayed different pH-readings, sometimes up to 0.4pH apart. This displayed a large problem and can be considered a major source of error. Using only one pH-sensor would eliminate this risk.
Time delay for inserting the pH-sensor.	When the 1% lipase is inserted into the boiling tube which contains milk and Orlistat or distilled water, it takes time for the pH-sensor to be re-inserted into the boiling tube. It also takes time to start the data collection process. The pH-sensor is very sensitive to changes in its environment, thus removing it from the boiling tube in the first place to allow the lipase to be added can cause the pH reading to drop slightly, even before the experiment has begun. To improve upon this, I would use a small funnel attached to the head of the syringe, and insert the head of this funnel into the boiling tube, whilst the pH-sensor is present. This will allow me to cut down on the time it takes to begin data collection. It also allows me to keep the pH-sensor within the milk, so there is no drop in pH at the beginning of the data collection process.
Measuring pH10.00 with different probes.	Each concentration of milk had 0.1M Na_2CO_3 added to it at 38°C until it reached pH10.00 The biggest issue with this is that pH10.00 measured with one pH probe was different than pH10.00 measured with another probe. This is the reason why there were varying starting pH values for the different tests. My method to improve this is to only use one pH probe.
Dilution of milk with 0.1M Na_2CO_3	When 0.1M Na_2CO_3 is added to the milk, the concentration of the milk will get even more diluted. This is an issue as if different volumes of the Na_2CO_3 are required for different concentrations, then the concentration of milk to distilled water will be different. To improve upon this, I would suggest that the Na_2CO_3 is added as part of an additional 10cm ³ to the samples. This is to say that if pH 10.00 is achieved within 5.30cm ³ then an additionally 4.70cm ³ of distilled water is added to the sample. This will make the number of moles of water slightly more accurate.

Old pH-sensors	The pH-sensors that were used are relatively old. This could mean that they have lost accuracy over time and this may have affected the data that I have collected. If one of the four pH-sensors that I used was damaged or faulty due to its age, it could have collected data which is not accurate. The actual error on the pH-sensor would also be higher than +/- 0.02 in this case.
----------------	--

Assumptions and Additional Considerations:

I must also take into account the reliability of some of my sources. One of my sources is the actual Xenical website. I used their fairly rudimentary explanation of how Orlistat works. Initially I also used their claim of Orlistat helping to 'block one-third of the fat in the food you eat from being digested' in my essay. However, after further research, I found an independent source from Xenical which stated that Orlistat only inhibits 25% of lipids from being absorbed by the body. I chose to quote the independent source (MedicineNet.com) rather than the Xenical website. ✓ Good.

It has to be recognized that my experiment aims to recreate a process that takes place inside the human body in a laboratory. My experiment lacks a few qualities that could affect the results of Orlistat. My experiment does not include bile salts, which mechanically break down lipids in the small intestine and increase surface area for lipase to act on these lipids. My experiment uses Porcine Lipase, and not Lipase from an actual human. Additionally, I have made the pH of the milk samples up to pH 10.00 whilst the pH in the small intestine and the optimum pH for lipase to work is around pH 8.0. ✓

An interesting idea. The experimental work shows evidence of personal input and there is a good understanding of the limitations. The background knowledge/information given is rather too basic - being on the syllabus - whereas little is given about 'orlistat' - its structure would be worth giving and discussing.

Bibliography

Books:

- Green, John, and Sadru Damji. Chemistry. Victoria: IBID P, 2007.
- Harwood, Richard, Mary Jones, and Brian Ratcliff. Biochemistry. New York: Cambridge UP, 2002.
- Stryer, Lubert. Biochemistry. 4th ed. Boston: W. H. Freeman & Company, 1995.
- Rodney, Boyer. Wie Concepts in Biochemistry. Third Edition, with the Interactive Concepts in Biochemistry Cd-Rom, International Edition. New York: John Wiley & Sons, Incorporated, 2006.

Websites:

- Boxall, Naomi. "Tertiary Structure." Massay University. 5 Oct. 2008
<<http://www.massey.ac.nz/~wwbioch/prot/thirds/framset.htm>>.
- Chasin, and Mowshowitz. "Intro Biology." 2005. Columbia University. 5 Oct. 2008
<<http://cubweb.biology.columbia.edu/introbio/faq/faq.php?years%5b%5d=0&exams%5b%5d=0&field=k&classid=1&search=1&query=%22enzyme%20kinetics%22>>.
- "Enzyme Function." Biology: Active Learner. 2002. Thompson Learning Inc. 2 Oct. 2008
<<http://www.dwm.ks.edu.tw/bio/activelearner/06/ch6c1.html>>.
- "Enzyme Inhibitor." Enzyme Inhibitor. Wikipedia. 5 Oct. 2008
<http://en.wikipedia.org/wiki/enzyme_inhibitor#irreversible_inhibitors>.
- Kaiser, Gary E. "Enzymes." BioTutorial. 27 June 2001. CCBCMD. 2 Oct. 2008
<<http://student.cbccmd.edu/biotutorials/proteins/enzyme.html>>.
- Kimball, J. "Enzymes." Kimball's Biology Page. 5 Sept. 2008. Harvard. 2 Oct. 2008
<<http://users.rcn.com/jkimball.ma.ultranet/biologypages/e/enzymes.html>>.
- "Lock&Key." Department of Chemistry. Washington University in St. Louis. 2 Oct. 2008
<<http://www.chemistry.wustl.edu/~edudev/labtutorials/carboxypeptidase/images/lockkey.jpg>>.
- Ogbru, Omudhome. "Orlistat." MedicineNet. 18 June 2007. MedicineNet. 2 Oct. 2008
<<http://www.medicinenet.com/orlistat/article.htm>>.
- Ophardt, Charles E. "Lock&Key." Virtual ChemBook. 2003. Elmhurst College. 2 Oct. 2008
<<http://www.elmhurst.edu/~chm/vchembook/571lockkey.html>>.
- Stevenson, Robert. "Non-Competitive Inhibitor." Bio12. 2 Oct. 2008
<http://www.bio12.com/ch6/remedialenzymes_files/image007.jpg>.
- Watters, Chris. "Lipids." Biology Reference. 2008. 5 Oct. 2008
<<http://www.biologyreference.com/la-ma/lipids.html>>.
- Wiley, John. "Competitive Inhibition." Enzymology. 1999. University of Miami. 2 Oct. 2008
<http://porpax.bio.miami.edu/~cmlery/255/255enz/competitive_inhibition.jpg>.
- "Xenical At Work." Xenical. 2008. Roche. 2 Oct. 2008
<http://www.xenical.com/xen_do_home.asp>.

Appendices

Appendix One

pH of Sample at different Arbitrary Concentrations and Omg Oilstat (pH +/- 0.02)

Time (sec)	1	1	0.9	0.9	0.9	0.8	0.8	0.7	0.7	0.7	0.6	0.6	0.5	0.5	0.4	0.4	0.4	0.3	0.3	0.2	0.2	0.1	0.1							
285	9.54	9.65	9.45	8.95	8.43	9.14	8.83	8.98	8.95	9.15	8.49	8.65	8.57	8.38	7.75	8.46	8.34	7.70	8.20	7.47	8.09	8.12	7.89	7.94	8.23	7.35	8.51	8.21	7.34	
290	9.54	9.65	9.45	8.97	8.36	9.08	8.74	8.95	8.88	9.13	8.45	8.50	8.54	8.48	7.78	8.42	8.32	7.68	8.14	7.44	8.07	8.06	7.88	7.99	8.75	8.25	7.33	8.50	8.19	7.33
295	9.53	9.64	9.42	8.94	8.31	9.02	8.74	8.90	8.83	9.10	8.42	8.58	8.50	8.48	7.88	8.40	8.46	7.68	8.17	7.44	8.04	8.05	7.88	7.96	8.71	8.25	7.31	8.49	8.22	7.32
300	9.53	9.63	9.41	8.87	8.25	8.96	8.69	8.86	8.80	9.07	8.39	8.57	8.47	8.40	7.64	8.36	8.46	7.64	8.16	7.41	8.02	8.04	7.84	7.92	8.67	8.19	7.29	8.47	8.11	7.32
305	9.52	9.62	9.40	8.86	8.19	8.92	8.64	8.80	8.83	9.04	8.35	8.58	8.42	8.42	7.61	8.34	8.40	7.62	8.17	7.40	7.98	8.05	7.82	7.91	8.64	8.08	7.28	8.47	8.12	7.32
310	9.51	9.62	9.40	8.79	8.13	8.96	8.60	8.76	8.75	9.01	8.31	8.55	8.40	8.32	7.60	8.30	8.37	7.60	8.14	7.38	7.97	8.05	7.81	7.93	8.61	8.05	7.26	8.45	8.12	7.31
315	9.51	9.61	9.38	8.64	8.09	8.81	8.57	8.71	8.75	8.97	8.27	8.48	8.36	8.29	7.57	8.28	8.37	7.59	8.14	7.36	7.95	8.02	7.80	7.92	8.56	8.03	7.24	8.44	8.00	7.31
320	9.50	9.60	9.38	8.70	8.04	8.75	8.53	8.68	8.70	8.94	8.25	8.41	8.33	8.28	7.54	8.24	8.41	7.57	8.13	7.39	7.92	8.06	7.78	7.93	8.55	8.05	7.22	8.42	8.00	7.30
325	9.49	9.59	9.37	8.68	8.00	8.71	8.48	8.52	8.58	8.90	8.22	8.37	8.31	8.28	7.52	8.22	8.30	7.55	8.18	7.34	7.91	8.04	7.77	7.90	8.52	8.06	7.22	8.42	7.88	7.30
330	9.49	9.59	9.36	8.64	7.96	8.66	8.45	8.57	8.55	8.82	8.19	8.37	8.25	8.24	7.51	8.19	8.39	7.54	8.17	7.32	7.87	7.98	7.74	7.87	8.49	8.02	7.20	8.40	8.03	7.29
335	9.49	9.58	9.35	8.63	7.91	8.62	8.42	8.53	8.53	8.82	8.17	8.37	8.25	8.31	7.48	8.17	8.40	7.53	8.16	7.32	7.87	7.98	7.74	7.89	8.47	8.01	7.19	8.40	8.06	7.29
340	9.48	9.57	9.34	8.56	7.88	8.58	8.39	8.48	8.51	8.78	8.14	8.36	8.22	8.34	7.46	8.15	8.28	7.52	8.10	7.31	7.86	7.98	7.74	7.89	8.44	8.05	7.18	8.39	8.04	7.29
345	9.47	9.56	9.33	8.51	7.83	8.54	8.35	8.45	8.57	8.74	8.12	8.32	8.20	8.27	7.44	8.13	8.31	7.50	8.08	7.30	7.84	7.97	7.72	7.86	8.41	8.04	7.16	8.38	8.03	7.29
350	9.47	9.55	9.31	8.52	7.80	8.49	8.32	8.42	8.57	8.70	8.09	8.32	8.17	8.27	7.44	8.11	8.37	7.49	8.08	7.28	7.82	7.92	7.66	7.89	8.39	8.39	7.15	8.37	8.05	7.28
355	9.46	9.55	9.30	8.46	7.77	8.47	8.29	8.39	8.55	8.65	8.06	8.31	8.14	8.31	7.41	8.08	8.34	7.48	8.07	7.27	7.82	7.92	7.69	7.83	8.36	7.97	7.15	8.36	8.04	7.28
360	9.45	9.54	9.30	8.49	7.75	8.43	8.26	8.35	8.50	8.61	8.04	8.30	8.12	8.22	7.39	8.06	8.35	7.46	8.08	7.26	7.78	7.98	7.67	7.84	8.34	8.02	7.14	8.35	7.94	7.28
365	9.44	9.52	9.28	8.37	7.72	8.40	8.18	8.33	8.46	8.57	8.02	8.29	8.11	8.23	7.37	7.99	8.04	8.30	8.30	7.28	7.77	7.96	7.67	7.82	8.32	7.96	7.13	8.34	8.00	7.28
370	9.44	9.51	9.27	8.33	7.70	8.37	8.12	8.30	8.49	8.52	8.02	8.49	8.12	8.30	7.40	8.02	8.30	7.45	8.08	7.26	7.74	7.97	7.65	7.79	8.30	7.95	7.12	8.34	8.11	7.27
375	9.43	9.51	9.25	8.34	7.69	8.34	8.09	8.27	8.43	8.48	7.98	8.30	8.05	8.21	7.36	8.00	8.17	7.43	8.05	7.24	7.74	7.95	7.64	7.78	8.28	7.91	7.12	8.33	8.14	7.27
380	9.42	9.50	9.24	8.33	7.67	8.31	8.05	8.24	8.41	8.44	7.97	8.24	8.05	8.20	7.34	7.98	8.01	7.42	8.03	7.22	7.73	7.91	7.64	7.81	8.25	7.90	7.11	8.32	8.12	7.27
385	9.41	9.49	9.22	8.20	7.63	8.28	8.02	8.22	8.43	8.40	7.94	8.26	8.02	8.44	7.33	7.97	7.86	7.41	8.02	7.22	7.72	7.73	7.63	7.78	8.24	7.93	7.10	8.31	7.99	7.27
390	9.41	9.48	9.20	8.31	7.63	8.25	8.00	8.20	8.41	8.36	7.93	8.26	8.01	8.19	7.32	7.95	8.17	7.40	8.04	7.21	7.71	7.92	7.62	7.74	8.22	7.93	7.10	8.30	8.07	7.27
395	9.40	9.47	9.19	8.31	7.61	8.23	7.97	8.18	8.38	8.32	7.90	8.23	7.98	8.34	7.31	7.93	8.05	7.39	8.03	7.21	7.68	7.92	7.60	7.81	8.20	7.89	7.09	8.30	8.08	7.27
400	9.39	9.46	9.17	8.33	7.60	8.20	7.96	8.16	8.31	8.28	7.89	8.23	7.96	8.11	7.30	7.82	8.10	7.39	8.00	7.19	7.67	7.90	7.60	7.78	8.18	7.87	7.08	8.28	8.07	7.27
405	9.38	9.44	9.16	8.11	7.59	8.18	7.93	8.14	8.30	8.14	7.88	8.18	7.96	8.14	7.29	7.89	8.03	7.38	8.02	7.18	7.66	7.90	7.60	7.80	8.17	7.88	7.08	8.28	8.06	7.26
410	9.37	9.44	9.12	8.19	7.53	8.13	7.89	8.11	8.30	8.15	7.85	8.19	7.91	8.10	7.28	7.88	7.96	7.36	8.01	7.17	7.65	7.97	7.57	7.85	8.13	7.87	7.07	8.27	8.05	7.26
415	9.36	9.42	9.09	8.27	7.54	8.11	7.88	8.09	8.30	8.11	7.84	8.16	7.90	8.08	7.26	7.86	8.03	7.35	7.96	7.14	7.64	7.86	7.57	7.83	8.15	7.86	7.07	8.27	8.16	7.26
420	9.35	9.41	9.07	8.17	7.53	8.09	7.86	8.07	8.28	8.08	7.82	8.18	7.89	8.06	7.25	7.83	8.03	7.34	7.99	7.15	7.62	7.93	7.55	7.83	8.10	7.86	7.06	8.26	8.08	7.25
425	9.34	9.40	9.05	8.13	7.52	8.06	7.84	8.06	8.25	8.01	7.80	8.19	7.85	8.05	7.24	7.82	7.97	7.33	7.98	7.15	7.60	7.89	7.55	7.82	8.08	7.79	7.05	8.24	8.05	7.25
430	9.34	9.39	9.03	8.07	7.50	8.05	7.83	8.05	8.25	8.01	7.80	8.19	7.85	8.05	7.24	7.82	7.97	7.33	7.98	7.15	7.60	7.89	7.55	7.82	8.08	7.79	7.05	8.24	8.05	7.25
435	9.32	9.38	9.00	7.89	7.49	8.04	7.81	8.03	8.26	7.97	7.78	8.23	7.84	8.03	7.23	7.81	7.96	7.32	7.95	7.14	7.60	7.88	7.54	7.79	8.07	7.88	7.04	8.23	8.06	7.25
440	9.32	9.37	8.97	8.18	7.48	8.01	7.80	8.02	8.20	7.94	7.77	7.99	7.82	8.01	7.22	7.78	7.97	7.31	7.97	7.13	7.57	7.87	7.53	7.91	8.05	7.85	7.03	8.22	8.11	7.25
445	9.31	9.37	8.97	8.18	7.48	8.01	7.80	8.02	8.20	7.94	7.77	7.99	7.82	8.01	7.22	7.78	7.97	7.31	7.97	7.13	7.57	7.87	7.53	7.91	8.05	7.85	7.03	8.22	8.11	7.25
450	9.31	9.36	8.94	8.04	7.47	7.99	7.79	8.01	8.20	7.91	7.76	7.89	7.89	8.19	7.19	7.75	7.97	7.30	7.97	7.11	7.56	7.83	7.51	7.82	8.02	7.84	7.03	8.21	8.06	7.24
455	9.30	9.34	8.91	8.13	7.46	7.97	7.77	7.99	8.19	7.89	7.74	7.80	8.00	8.00	7.20	7.77	7.96	7.30	7.95	7.13	7.57	7.86	7.52	7.81	8.04	7.85	7.03	8.21	8.09	7.25
460	9.29	9.33	8.87	8.13	7.45	7.97	7.76	7.98	8.32	7.86	7.74	7.84	8.15	7.79	7.19	7.75	7.97	7.30	7.97	7.11	7.56	7.83	7.51	7.82	8.02	7.84	7.03	8.21	8.06	7.24
465	9.28	9.31	8.84	8.06	7.44	7.95	7.75	7.97	8.20	7.83	7.72	7.87	8.16	7.78	7.18	7.75	7.97	7.30	7.97	7.11	7.56	7.83	7.51	7.82	8.02	7.84	7.03	8.21	8.06	7.24
470	9.27	9.29	8.79	8.14	7.43	7.94	7.74	7.96	8.16	7.81	7.71	7.81	8.18	7.77	7.18	7.73	7.97	7.28	7.93	7.10	7.52	7.83	7.49	7.86	8.00	7.85	7.01	8.20	7.98	7.23
475	9.26	9.28	8.73	8.12	7.42	7.92	7.72	7.97	8.18	7.79	7.70	7.76	8.08	7.78	7.18	7.73	7.97	7.28	7.93	7.10	7.52	7.83	7.49	7.86	8.00	7.85	7.01	8.20	7.98	7.23
480	9.25	9.26	8.68	8.12	7.41	7.90	7.71	7.94	8.17	7.76	7.69	7.89	8.10	7.75	7.17	7.73	7.91	7.27	7.96	7.10	7.52	7.84	7.48	7.88	7.98	7.78	7.01	8.19	8.05	7.23
485	9.24	9.24	8.63	8.16	7.40	7.89	7.70	7.94	8.15	7.75	7.68	7.88	8.10	7.74	7.17	7.72	7.90	7.27	7.92	7.10	7.51	7.83	7.48	7.85	7.97	7.78	7.01	8.19	8.05	7.23
490	9.23	9.22	8.56	7.90	7.39	7.88	7.69	7.94	8.12	7.72	7.67	7.87	8.10	7.74	7.14	7.74	7.94	7.26	7.89	7.09	7.50	7.86	7.48	7.79	7.97	7.77	7.00	8.19	8.07	7.24
495	9.23	9.19	8.50	7.83	7.38	7.87	7.69	7.83	8.13	7.70	7.67	7.87	8.12	7.73	7.39	7.67	7.97	7.26												

pH of Sample at different Arbitrary Concentrations and 0mg Orlistat (pH +/- 0.02)

Time (sec)	1	1	1	0.9	0.9	0.9	0.8	0.8	0.8	0.7	0.7	0.6	0.6	0.5	0.5	0.5	0.4	0.4	0.4	0.3	0.3	0.2	0.2	0.1	0.1					
570	8.94	8.50	7.66	8.07	7.29	7.71	7.58	7.82	8.08	7.49	7.57	7.98	7.61	7.95	7.08	7.84	7.18	7.86	7.02	7.42	7.78	7.39	7.82	7.85	7.78	6.96	8.12	8.05	7.23	
575	8.91	8.44	7.63	8.05	7.29	7.71	7.57	7.82	8.10	7.48	7.55	8.07	7.60	7.94	7.08	7.59	7.92	7.18	7.84	7.01	7.41	7.79	7.39	7.82	7.84	7.77	6.95	8.12	8.05	7.23
580	8.88	8.39	7.60	7.98	7.27	7.70	7.56	7.81	8.06	7.47	7.55	8.00	7.59	8.02	7.07	7.58	7.91	7.18	7.80	7.01	7.40	7.77	7.38	7.84	7.84	7.75	6.95	8.11	8.05	7.23
585	8.84	8.34	7.56	8.01	7.27	7.69	7.56	7.80	8.20	7.46	7.54	7.97	7.58	7.94	7.07	7.58	7.88	7.18	7.60	7.01	7.40	7.79	7.39	7.82	7.76	6.94	8.11	8.02	7.22	
590	8.80	8.28	7.53	8.11	7.27	7.68	7.54	7.80	8.04	7.45	7.53	8.02	7.57	7.94	7.08	7.57	7.91	7.17	7.75	7.01	7.39	7.77	7.38	7.83	7.83	7.72	6.94	8.11	8.07	7.23
595	8.76	8.23	7.50	8.04	7.26	7.68	7.54	7.79	8.03	7.44	7.53	8.02	7.57	7.90	7.07	7.56	7.71	7.16	7.89	7.00	7.38	7.77	7.37	7.89	7.82	7.73	6.93	8.11	7.97	7.23
600	8.72	8.18	7.47	7.95	7.25	7.67	7.54	7.78	8.03	7.44	7.52	7.97	7.57	7.90	7.07	7.56	7.71	7.16	7.89	7.00	7.38	7.77	7.37	7.81	7.81	7.71	6.93	8.11	7.98	7.23
605	8.68	8.14	7.45	8.03	7.25	7.66	7.53	7.78	8.01	7.43	7.52	7.97	7.57	7.89	7.06	7.55	7.78	7.16	7.95	7.00	7.39	7.77	7.37	7.81	7.81	7.71	6.93	8.11	7.98	7.23
610	8.64	8.09	7.42	8.02	7.25	7.65	7.52	7.77	8.04	7.42	7.52	7.90	7.55	7.90	7.05	7.55	7.83	7.15	7.89	7.00	7.38	7.77	7.36	7.81	7.81	7.70	6.93	8.10	7.82	7.23
615	8.60	8.05	7.39	7.97	7.24	7.65	7.52	7.76	8.03	7.41	7.51	8.00	7.55	7.90	7.05	7.55	7.91	7.16	7.90	6.99	7.37	7.83	7.37	7.80	7.80	7.69	6.93	8.11	7.87	7.23
620	8.56	8.01	7.38	7.96	7.24	7.64	7.52	7.76	8.02	7.40	7.51	8.02	7.54	7.90	7.04	7.54	7.91	7.15	7.86	6.99	7.37	7.85	7.36	7.74	7.79	7.71	6.91	8.10	7.70	7.23
625	8.51	7.97	7.36	8.07	7.23	7.63	7.50	7.75	8.09	7.39	7.50	8.03	7.53	7.90	7.04	7.54	8.00	7.15	7.89	6.99	7.37	7.81	7.36	7.78	7.72	6.89	8.10	7.72	7.23	
630	8.47	7.93	7.34	7.99	7.22	7.64	7.50	7.75	8.10	7.39	7.51	8.04	7.53	7.95	7.05	7.54	7.82	7.15	7.90	6.98	7.37	7.74	7.35	7.78	7.79	7.66	6.91	8.10	7.88	7.23
635	8.43	7.90	7.31	7.99	7.22	7.62	7.50	7.75	8.03	7.39	7.49	7.98	7.53	7.94	7.04	7.53	7.90	7.15	7.88	6.98	7.37	7.76	7.35	7.79	7.78	7.66	6.90	8.09	7.68	7.23
640	8.39	7.86	7.29	8.03	7.22	7.62	7.50	7.75	8.02	7.37	7.50	7.97	7.53	7.91	7.03	7.52	7.89	7.14	7.82	6.98	7.36	7.73	7.35	7.77	7.77	7.76	6.91	8.10	7.93	7.22
645	8.35	7.84	7.28	7.87	7.22	7.61	7.49	7.74	8.01	7.37	7.49	7.99	7.52	7.92	7.03	7.52	7.79	7.15	7.82	6.97	7.36	7.76	7.36	7.79	7.77	7.74	6.91	8.10	7.91	7.23
650	8.31	7.80	7.27	7.88	7.21	7.61	7.48	7.73	8.01	7.36	7.48	8.06	7.51	7.90	7.03	7.52	7.97	7.14	7.84	6.98	7.36	7.75	7.34	7.75	7.76	7.72	6.91	8.10	7.83	7.23
655	8.27	7.77	7.24	7.91	7.21	7.60	7.47	7.73	8.01	7.36	7.48	8.01	7.52	7.95	7.03	7.52	8.03	7.14	7.84	6.97	7.36	7.74	7.34	7.75	7.76	7.70	6.91	8.10	7.97	7.23
660	8.23	7.75	7.23	8.01	7.21	7.60	7.47	7.72	8.01	7.35	7.48	8.04	7.51	7.95	7.02	7.51	7.98	7.13	7.84	6.96	7.36	7.73	7.34	7.78	7.75	7.73	6.91	8.10	7.96	7.23
665	8.20	7.72	7.22	7.95	7.21	7.59	7.47	7.72	8.09	7.34	7.48	7.96	7.51	7.92	7.02	7.51	7.98	7.12	7.82	6.96	7.35	7.76	7.33	7.74	7.75	7.70	6.90	8.10	7.95	7.23
670	8.16	7.69	7.20	7.92	7.20	7.59	7.47	7.72	8.01	7.33	7.46	8.01	7.50	7.92	7.02	7.51	7.98	7.12	7.82	6.96	7.35	7.76	7.33	7.74	7.75	7.70	6.90	8.09	7.94	7.23
675	8.13	7.67	7.19	7.94	7.20	7.58	7.46	7.71	7.99	7.33	7.47	8.01	7.50	7.90	7.02	7.50	7.98	7.13	7.81	6.96	7.34	7.74	7.32	7.71	7.75	7.68	6.90	8.08	7.96	7.22
680	8.09	7.65	7.17	7.90	7.19	7.59	7.46	7.71	8.05	7.32	7.45	8.01	7.50	7.91	7.01	7.50	7.95	7.12	7.58	6.96	7.33	7.72	7.32	7.76	7.74	7.69	6.89	8.09	7.96	7.22
685	8.08	7.63	7.16	7.86	7.18	7.57	7.46	7.70	8.05	7.31	7.45	8.01	7.49	7.90	7.01	7.49	7.99	7.11	7.67	6.96	7.33	7.71	7.31	7.74	7.74	7.67	6.89	8.09	7.89	7.22
690	8.03	7.61	7.15	7.89	7.18	7.57	7.45	7.70	8.02	7.31	7.45	8.01	7.49	7.90	7.01	7.49	7.93	7.11	7.90	6.95	7.33	7.71	7.32	7.74	7.74	7.67	6.89	8.10	7.91	7.23
695	7.99	7.59	7.14	7.90	7.18	7.56	7.45	7.69	8.02	7.31	7.45	8.03	7.48	7.87	7.00	7.48	8.00	7.12	7.92	6.95	7.32	7.69	7.32	7.76	7.73	7.59	6.89	8.08	7.92	7.22
700	7.96	7.58	7.13	7.93	7.17	7.57	7.45	7.69	8.00	7.30	7.45	8.02	7.47	7.86	7.00	7.48	8.00	7.11	7.79	6.94	7.33	7.92	7.32	7.73	7.73	7.59	6.89	8.09	7.78	7.22
705	7.93	7.56	7.12	7.72	7.17	7.56	7.44	7.68	8.02	7.30	7.44	8.02	7.48	7.85	7.00	7.48	7.93	7.10	7.77	6.94	7.33	7.71	7.31	7.75	7.73	7.67	6.88	8.08	7.95	7.22
710	7.91	7.54	7.11	8.03	7.17	7.55	7.43	7.68	8.02	7.29	7.44	7.98	7.47	7.88	7.00	7.48	7.95	7.10	7.75	6.94	7.31	7.73	7.31	7.76	7.72	7.66	6.88	8.08	7.95	7.22
715	7.87	7.52	7.10	8.07	7.16	7.55	7.43	7.68	8.02	7.29	7.44	7.94	7.46	7.87	7.00	7.48	7.80	7.10	7.76	6.94	7.31	7.76	7.30	7.71	7.71	7.67	6.88	8.08	7.92	7.22
720	7.85	7.50	7.09	8.03	7.16	7.54	7.43	7.67	7.97	7.28	7.43	7.97	7.46	7.86	6.99	7.47	7.95	7.10	7.74	6.93	7.32	7.74	7.30	7.76	7.71	7.71	6.87	8.08	7.89	7.22
725	7.82	7.49	7.08	7.97	7.16	7.55	7.43	7.67	8.00	7.28	7.43	7.99	7.45	7.89	6.99	7.47	7.99	7.10	7.49	6.94	7.31	7.74	7.30	7.76	7.71	7.71	6.87	8.08	7.94	7.21
730	7.80	7.48	7.06	7.91	7.15	7.54	7.43	7.67	7.99	7.26	7.43	7.98	7.45	7.87	7.00	7.47	7.94	7.09	7.60	6.93	7.31	7.74	7.30	7.76	7.70	7.68	6.87	8.08	7.97	7.22
735	7.77	7.46	7.06	7.98	7.15	7.53	7.41	7.67	7.97	7.26	7.42	7.87	7.45	7.84	6.99	7.47	7.96	7.09	7.49	6.93	7.30	7.74	7.29	7.75	7.70	7.56	6.87	8.07	7.98	7.21
740	7.75	7.45	7.05	7.99	7.15	7.53	7.42	7.66	7.93	7.25	7.43	7.95	7.46	7.81	6.99	7.46	7.97	7.09	7.53	6.93	7.30	7.72	7.29	7.76	7.70	7.69	6.87	8.08	8.01	7.21
745	7.72	7.44	7.04	7.95	7.15	7.53	7.41	7.66	7.98	7.25	7.42	7.90	7.45	7.82	6.98	7.45	7.81	7.09	7.57	6.93	7.30	7.77	7.29	7.76	7.69	7.69	6.87	8.07	7.92	7.21
750	7.70	7.43	7.04	7.95	7.14	7.52	7.41	7.66	7.99	7.24	7.42	7.88	7.44	7.81	6.99	7.45	7.95	7.08	7.74	6.93	7.30	7.75	7.29	7.79	7.69	7.69	6.87	8.07	7.96	7.21
755	7.68	7.42	7.03	7.94	7.14	7.52	7.41	7.65	8.00	7.24	7.42	7.88	7.44	7.79	6.98	7.46	7.94	7.08	7.77	6.93	7.30	7.70	7.30	7.83	7.69	7.72	6.87	8.07	7.92	7.21
760	7.66	7.41	7.02	7.88	7.14	7.52	7.41	7.65	7.97	7.23	7.40	7.89	7.44	7.81	6.98	7.44	7.99	7.07	7.70	6.92	7.30	7.72	7.28	7.84	7.69	7.60	6.86	8.07	8.00	7.21
765	7.64	7.40	7.02	7.95	7.13	7.51	7.41	7.65	8.00	7.23	7.40	7.86	7.43	7.83	6.98	7.45	7.97	7.07	7.72	6.92	7.29	7.73	7.29	7.79	7.68	7.68	6.86	8.07	8.04	7.21
770	7.62	7.39	7.00	7.97	7.13	7.52	7.39	7.64	8.01	7.22	7.41	7.92	7.44	7.80	6.98	7.44	7.89	7.07	7.43	6.92	7.29	7.70	7.28	7.75	7.68	7.60	6.86	8.07	8.01	7.20
775	7.60	7.38	7.00	7.97	7.12	7.51	7.40	7.64	8.04	7.22	7.41	7.96	7.43	7.78	6.98	7.44	7.89	7.07	7.63	6.92	7.30	7.76	7.29	7.67	7.67	7.65	6.86	8.06	8.01	7.21
780	7.58	7.37	6.99	7.91	7.12	7.50	7.38	7.64	8.04	7.22	7.40	7.88	7.42	7.78	6.98	7.44	7.96	7.07	7.66	6										

pH of Sample at different Arbitrary Concentrations and 0mg Orlistat (pH +/- 0.02)

Time (sec)	1	1	1	0.9	0.9	0.9	0.8	0.8	0.7	0.7	0.7	0.6	0.6	0.6	0.5	0.5	0.5	0.4	0.4	0.4	0.4	0.3	0.3	0.3	0.2	0.2	0.2	0.1	0.1	0.1
855	7.34	7.25	6.90	7.92	7.07	7.46	7.36	7.59	7.96	7.17	7.37	7.83	7.39	7.77	6.95	7.42	7.78	7.04	7.69	6.89	7.25	7.66	7.25	7.69	7.63	7.72	6.85	8.04	7.98	7.19
860	7.34	7.25	6.90	7.96	7.07	7.45	7.36	7.58	7.94	7.17	7.36	7.83	7.37	7.77	6.95	7.42	7.82	7.04	7.75	6.88	7.26	7.78	7.25	7.71	7.63	7.80	6.85	8.03	7.98	7.19
865	7.32	7.24	6.89	8.04	7.07	7.45	7.35	7.59	7.95	7.16	7.37	7.82	7.38	7.79	6.94	7.42	7.93	7.04	7.69	6.89	7.25	7.66	7.25	7.78	7.63	7.80	6.85	8.03	7.96	7.19
870	7.31	7.23	6.89	7.99	7.07	7.45	7.35	7.68	7.85	7.17	7.36	7.84	7.37	7.79	6.94	7.41	7.97	7.04	7.68	6.88	7.25	7.64	7.25	7.80	7.62	7.82	6.85	8.03	7.94	7.19
875	7.30	7.23	6.89	7.99	7.07	7.45	7.35	7.58	7.96	7.16	7.35	7.80	7.37	7.80	6.95	7.41	7.89	7.03	7.67	6.89	7.25	7.62	7.25	7.73	7.62	7.82	6.85	8.03	7.95	7.19
880	7.29	7.23	6.88	8.04	7.06	7.45	7.34	7.68	7.91	7.16	7.36	7.83	7.38	7.80	6.95	7.40	7.91	7.03	7.67	6.88	7.25	7.67	7.24	7.71	7.62	7.82	6.85	8.03	7.94	7.19
885	7.28	7.22	6.88	7.97	7.06	7.44	7.34	7.58	7.91	7.16	7.35	7.86	7.37	7.82	6.94	7.40	7.84	7.03	7.70	6.89	7.25	7.67	7.25	7.69	7.62	7.83	6.85	8.03	7.93	7.19
890	7.27	7.22	6.87	7.96	7.06	7.45	7.34	7.58	7.94	7.16	7.34	7.87	7.36	7.82	6.94	7.40	7.80	7.03	7.75	6.88	7.25	7.64	7.24	7.69	7.62	7.83	6.85	8.03	7.92	7.19
895	7.26	7.21	6.87	7.98	7.06	7.45	7.34	7.57	7.91	7.16	7.34	7.86	7.37	7.81	6.94	7.40	7.94	7.03	7.43	6.88	7.24	7.63	7.25	7.61	7.62	7.80	6.85	8.03	7.96	7.19
900	7.25	7.21	6.87	7.97	7.06	7.44	7.34	7.57	7.90	7.15	7.35	7.82	7.36	7.80	6.94	7.40	7.95	7.03	7.69	6.88	7.24	7.66	7.23	7.65	7.61	7.54	6.85	8.02	7.93	7.19

Table 1.2

pH of Sample at different Arbitrary Concentrations and 60mg Orlistat (pH +/- 0.02)

Time (sec)	1	1	1	0.9	0.9	0.8	0.8	0.8	0.7	0.7	0.6	0.6	0.5	0.5	0.4	0.4	0.3	0.3	0.2	0.2	0.1	0.1	
0	9.56	9.52	10.07	10.09	10.05	9.63	9.63	9.61	9.91	9.93	9.89	9.61	9.65	9.61	9.38	9.34	10.42	10.44	9.16	9.12	9.63	9.65	
5	9.56	9.59	9.53	10.06	10.09	9.64	9.64	9.58	9.91	9.93	9.87	9.52	9.55	9.49	9.36	9.36	10.37	10.40	9.15	9.18	9.12	9.64	
10	9.55	9.58	9.48	10.04	10.07	9.62	9.62	9.56	9.90	9.93	9.87	9.48	9.51	9.45	9.34	9.31	10.34	10.37	9.10	9.13	9.07	9.67	
15	9.54	9.57	9.50	10.03	10.07	9.59	9.59	9.53	9.88	9.92	9.84	9.45	9.48	9.41	9.30	9.29	10.29	10.33	9.04	9.08	9.03	9.67	
20	9.54	9.54	9.53	10.01	10.04	9.58	9.58	9.53	9.87	9.91	9.84	9.43	9.46	9.40	9.32	9.35	10.28	10.32	9.01	9.04	8.96	9.69	
25	9.53	9.56	9.49	10.00	10.02	9.56	9.56	9.51	9.85	9.88	9.83	9.44	9.46	9.42	9.34	9.29	10.23	10.25	8.97	8.99	8.95	9.69	
30	9.52	9.56	9.49	9.99	10.02	9.56	9.56	9.51	9.84	9.87	9.81	9.37	9.40	9.34	9.32	9.26	10.23	10.17	8.95	8.98	8.92	9.61	
35	9.50	9.53	9.48	9.99	10.01	9.53	9.53	9.51	9.84	9.86	9.82	9.39	9.42	9.35	9.29	9.31	10.20	10.16	8.92	8.94	8.90	9.55	
40	9.49	9.50	9.45	9.98	10.01	9.52	9.52	9.49	9.82	9.85	9.79	9.46	9.49	9.43	9.47	9.50	10.18	10.12	8.89	8.92	8.86	9.51	
45	9.47	9.48	9.43	9.96	9.99	9.51	9.51	9.44	9.81	9.84	9.78	9.46	9.49	9.43	9.47	9.30	10.16	10.10	8.87	8.90	8.84	9.49	
50	9.46	9.50	9.43	9.95	9.97	9.50	9.52	9.48	9.80	9.82	9.78	9.29	9.31	9.27	9.28	9.24	10.11	10.13	8.85	8.87	8.83	9.48	
55	9.45	9.48	9.38	9.94	9.96	9.49	9.49	9.41	9.47	9.49	9.47	9.26	9.28	9.24	9.26	9.24	10.11	10.13	8.85	8.87	8.83	9.48	
60	9.43	9.46	9.39	9.92	9.94	9.49	9.49	9.45	9.45	9.45	9.45	9.26	9.28	9.24	9.26	9.24	10.09	10.11	8.85	8.85	8.81	9.44	
65	9.41	9.44	9.40	9.92	9.94	9.46	9.46	9.44	9.44	9.44	9.44	9.22	9.24	9.20	9.25	9.21	10.03	10.05	8.78	8.80	8.76	9.41	
70	9.39	9.40	9.35	9.90	9.94	9.46	9.46	9.44	9.44	9.44	9.44	9.21	9.23	9.19	9.14	9.16	10.05	10.07	8.76	8.80	8.72	9.39	
75	9.38	9.43	9.35	9.89	9.91	9.42	9.42	9.40	9.40	9.40	9.40	9.21	9.23	9.19	9.14	9.16	10.05	10.07	8.76	8.80	8.72	9.39	
80	9.35	9.39	9.33	9.87	9.90	9.40	9.40	9.43	9.37	9.37	9.37	9.20	9.23	9.17	9.20	9.23	9.17	9.96	9.99	8.73	8.75	8.69	9.36
85	9.33	9.36	9.29	9.86	9.89	9.39	9.42	9.36	9.36	9.36	9.36	9.12	9.15	9.10	9.15	9.15	9.93	9.96	8.70	8.73	8.67	9.34	
90	9.31	9.32	9.27	9.85	9.88	9.37	9.41	9.33	9.33	9.33	9.33	9.11	9.15	9.07	9.21	9.21	9.91	9.95	8.67	8.69	8.73	9.37	
95	9.30	9.30	9.27	9.84	9.87	9.31	9.31	9.31	9.31	9.31	9.31	9.07	9.10	9.04	9.16	9.16	9.89	9.92	8.66	8.69	8.63	9.31	
100	9.27	9.31	9.20	9.84	9.86	9.32	9.34	9.30	9.30	9.30	9.30	9.16	9.14	9.14	9.14	9.14	9.87	9.89	8.65	8.67	8.63	9.30	
105	9.26	9.29	9.22	9.82	9.85	9.29	9.33	9.27	9.27	9.27	9.27	9.02	9.02	9.02	9.02	9.02	9.84	9.84	8.63	8.66	8.60	9.29	
110	9.24	9.27	9.23	9.81	9.83	9.28	9.30	9.26	9.26	9.26	9.26	8.98	9.16	9.14	9.14	9.14	9.82	9.84	8.60	8.62	8.58	9.28	
115	9.22	9.25	9.18	9.80	9.83	9.27	9.29	9.23	9.23	9.23	9.23	8.99	9.13	9.16	9.10	9.09	9.79	9.82	8.59	8.62	8.56	9.27	
120	9.20	9.21	9.17	9.78	9.81	9.25	9.24	9.21	9.21	9.21	9.21	8.94	9.07	9.11	9.11	9.11	9.75	9.78	8.57	8.60	8.54	9.27	
125	9.17	9.22	9.15	9.77	9.79	9.25	9.24	9.20	9.20	9.20	9.20	8.96	9.06	9.10	9.06	9.06	9.73	9.75	8.55	8.57	8.53	9.25	
130	9.16	9.20	9.12	9.76	9.78	9.24	9.24	9.20	9.20	9.20	9.20	8.96	9.06	9.10	9.06	9.06	9.71	9.71	8.55	8.57	8.53	9.25	
135	9.14	9.17	9.10	9.74	9.76	9.21	9.21	9.19	9.19	9.19	9.19	8.86	8.94	9.06	9.02	9.03	9.65	9.67	8.50	8.52	8.48	9.23	
140	9.12	9.13	9.09	9.73	9.75	9.21	9.21	9.13	9.13	9.13	9.13	8.85	8.91	9.02	9.00	9.01	9.63	9.63	8.46	8.51	8.47	9.24	
145	9.10	9.11	9.03	9.71	9.75	9.17	9.17	9.09	9.09	9.09	9.09	8.82	8.86	8.78	8.83	8.83	9.58	9.58	8.46	8.50	8.42	9.21	
150	9.08	9.12	9.04	9.69	9.71	9.07	9.10	9.08	9.08	9.08	9.08	8.79	8.87	8.99	8.95	8.97	9.56	9.56	8.43	8.45	8.41	9.20	
155	9.06	9.09	9.05	9.68	9.71	9.05	9.12	9.05	9.05	9.05	9.05	8.81	8.87	8.91	8.95	8.98	9.51	9.54	8.41	8.44	8.38	9.22	
160	9.04	9.07	9.00	9.67	9.70	9.06	9.08	9.03	9.03	9.03	9.03	8.82	8.85	8.89	8.93	8.96	9.46	9.49	8.39	8.42	8.36	9.21	
165	9.02	9.05	8.99	9.65	9.69	9.01	9.04	9.00	9.01	9.01	9.01	8.81	8.85	8.86	8.91	8.95	9.44	9.48	8.36	8.40	8.32	9.21	
170	9.00	9.01	8.98	9.63	9.66	9.00	9.02	9.05	9.05	9.05	9.05	8.81	8.85	8.88	8.91	8.95	9.40	9.43	8.34	8.37	8.31	9.21	
175	8.98	9.03	8.94	9.61	9.63	9.00	9.02	9.08	9.08	9.08	9.08	8.82	8.86	8.88	8.94	8.96	9.38	9.38	8.32	8.34	8.30	9.20	
180	8.96	9.00	8.92	9.60	9.63	9.01	9.01	9.05	9.05	9.05	9.05	8.70	8.73	8.67	8.83	8.86	9.34	9.37	8.29	8.32	8.26	9.18	
185	8.94	8.97	8.91	9.59	9.60	8.98	8.98	8.94	8.94	8.94	8.94	8.60	8.61	8.63	8.79	8.80	9.30	9.32	8.27	8.29	8.25	9.19	
190	8.92	8.93	8.85	9.57	9.60	8.94	8.97	8.91	8.91	8.91	8.91	8.76	8.76	8.76	8.76	8.76	9.28	9.31	8.25	8.28	8.22	9.18	
195	8.90	8.91	8.86	9.55	9.58	8.92	8.93	8.88	8.90	8.90	8.90	8.74	8.74	8.74	8.74	8.74	9.28	9.28	8.22	8.25	8.19	9.20	
200	8.88	8.92	8.87	9.54	9.56	8.92	8.93	8.89	8.92	8.92	8.92	8.72	8.72	8.72	8.72	8.72	9.25	9.25	8.22	8.22	8.18	9.19	
205	8.87	8.90	8.83	9.52	9.54	8.90	8.91	8.87	8.87	8.87	8.87	8.71	8.71	8.71	8.71	8.71	9.22	9.22	8.18	8.20	8.16	9.19	
210	8.85	8.88	8.82	9.51	9.53	8.89	8.89	8.85	8.85	8.85	8.85	8.68	8.68	8.68	8.68	8.68	9.18	9.20	8.16	8.16	8.14	9.19	
215	8.83	8.86	8.81	9.49	9.51	8.86	8.86	8.84	8.84	8.84	8.84	8.66	8.66	8.66	8.66	8.66	9.17	9.17	8.14	8.16	8.12	9.15	
220	8.81	8.82	8.77	9.47	9.51	8.83	8.83	8.79	8.79	8.79	8.79	8.59	8.63	8.60	8.55	8.55	9.13	9.13	8.09	8.12	8.08	9.15	
225	8.79	8.84	8.75	9.46	9.48	8.81	8.83	8.79	8.79	8.79	8.79	8.73	8.73	8.73	8.73	8.73	9.11	9.13	8.09	8.11	8.13	9.16	
230	8.78	8.82	8.75	9.45	9.48	8.80	8.83	8.77	8.77	8.77	8.77	8.58	8.58	8.58	8.58	8.58	9.09	9.12	8.08	8.11	8.05	9.13	
235	8.76	8.79	8.69	9.43	9.46	8.78	8.81	8.75	8.75	8.75	8.75	8.54	8.54	8.54	8.54	8.54	9.04	9.04	8.04	8.10	8.04	9.12	
240	8.75	8.76	8.71	9.41	9.45	8.77	8.80	8.72	8.72	8.72	8.72	8.64	8.64	8.64	8.64	8.64	9.01	9.01	8.05	8.09	8.01	9.16	
245	8.73	8.74	8.72	9.40	9.43	8.73	8.73	8.76	8.76	8.76	8.76	8.65	8.65	8.65	8.65	8.65	9.03	9.03	8.04	8.07	8.01	9.14	
250	8.72	8.76	8.68	9.39	9.41	8.71	8.73	8.69	8.69	8.69	8.69	8.51	8.49	8.51	8.47	8.32	9.04	9.02	8.04	8.04	8.01	9.13	
255	8.70	8.73	8.67	9.37	9.40	8.64	8.69	8.72	8.66	8.66	8.66	8.50	8.47	8.50	8.44	8.29	9.00	9.00	8.04	8.07	8.04	9.13	
260	8.68	8.71	8.66	9.36	9.38	8.64	8.67	8.69	8.65	8.65	8.65	8.47	8.43	8.26	8.24	8.24	8.99	9.01	7.97	7.99	8.01	9.07	
265	8.67	8.63	8.63	9.36	9.36	8.64	8.67	8.61	8.61	8.61	8.61	8.45	8.45	8.45	8.45	8.45	8.97	9.00	7.94	7.97	8.00	9.12	
270	8.65	8.68	8.61	9.32	9.35	8.62	8.65	8.59	8.77	8.80	8.74	8.33	8.36	8.30	8.42	8.45	8.96	8.99	7.94	7.94	8.08	9.11	
275	8.64	8.69	8.61	9.31	9.33	8.59	8.61	8.57	8.72	8.74	8.70	8.44	8.46	8.42	8.40	8.42	8.96	8.96	7.95	7.97	7.93	9.07	

pH of Sample at different Arbitrary Concentrations and 60mg Orlistat (pH +/- 0.02)

Time (sec)	1	1	0.9	0.9	0.8	0.8	0.8	0.7	0.7	0.7	0.6	0.6	0.6	0.5	0.5	0.5	0.4	0.4	0.4	0.3	0.3	0.3	0.2	0.2	0.2	0.1	0.1
280	8.62	8.66	8.55	9.30	9.32	9.28	8.56	8.54	8.69	8.71	8.67	8.49	8.51	8.47	8.40	8.42	8.16	8.12	8.92	8.94	8.90	7.94	7.92	7.92	9.07	9.08	9.05
285	8.60	8.63	8.56	9.28	9.30	9.26	8.53	8.55	8.51	8.66	8.67	8.46	8.48	8.44	8.38	8.40	8.14	8.10	8.89	8.91	8.87	7.93	7.91	7.91	9.06	9.08	9.04
290	8.59	8.69	8.57	9.27	9.29	9.25	8.50	8.52	8.48	8.61	8.63	8.59	8.43	8.47	8.39	8.40	8.11	8.07	8.90	8.92	8.88	7.92	7.94	7.90	9.06	9.08	9.04
295	8.56	8.57	8.52	9.24	9.24	9.26	8.48	8.42	8.52	8.62	8.54	8.43	8.47	8.39	8.36	8.40	8.32	8.07	8.11	8.03	8.87	8.91	7.91	7.91	7.87	9.06	9.10
300	8.54	8.58	8.51	9.24	9.26	9.22	8.46	8.47	8.43	8.56	8.58	8.54	8.40	8.42	8.35	8.37	8.33	8.05	8.07	8.03	8.85	8.86	7.89	7.91	7.87	9.05	9.07
305	8.51	8.54	8.49	9.22	9.25	9.19	8.42	8.45	8.39	8.53	8.56	8.50	8.40	8.43	8.37	8.34	8.04	8.07	8.01	8.85	8.88	7.89	7.91	7.85	9.04	9.07	9.01
310	8.48	8.52	8.45	9.18	9.24	9.18	8.39	8.42	8.36	8.50	8.53	8.47	8.30	8.34	8.33	8.31	8.01	8.04	7.98	8.84	8.87	7.86	7.91	7.85	9.04	9.07	9.01
315	8.47	8.50	8.43	9.19	9.23	9.15	8.37	8.41	8.33	8.48	8.52	8.44	8.26	8.30	8.22	8.24	8.00	8.04	7.96	8.83	8.87	7.87	7.91	7.83	9.03	9.07	9.03
320	8.45	8.46	8.42	9.18	9.21	9.15	8.34	8.37	8.31	8.46	8.49	8.43	8.24	8.27	8.21	8.23	8.33	8.39	8.30	8.30	8.30	7.88	7.88	7.82	9.03	9.05	9.03
325	8.42	8.47	8.35	9.17	9.19	9.16	8.32	8.33	8.30	8.44	8.46	8.42	8.23	8.26	8.21	8.32	8.34	8.30	7.97	7.99	7.95	7.93	7.94	7.86	7.82	9.02	9.04
330	8.39	8.43	8.35	9.15	9.12	9.12	8.30	8.34	8.27	8.42	8.45	8.39	8.20	8.25	8.20	8.31	8.34	8.28	7.96	7.98	7.92	7.92	7.83	7.86	7.80	9.02	9.05
335	8.37	8.40	8.36	9.13	9.15	9.11	8.28	8.30	8.26	8.40	8.42	8.38	8.23	8.25	8.21	8.30	8.32	8.28	7.93	7.95	7.91	7.91	7.83	7.83	7.85	7.81	9.01
340	8.34	8.35	8.30	9.12	9.13	9.09	8.26	8.29	8.22	8.38	8.41	8.35	8.10	8.13	8.03	8.03	8.03	7.92	7.95	7.89	7.89	7.81	7.82	7.85	7.79	9.00	9.03
345	8.30	8.31	8.27	9.10	9.13	9.07	8.25	8.28	8.21	8.34	8.36	8.32	8.25	8.27	8.23	8.28	8.29	8.26	7.90	7.93	7.90	7.87	7.87	7.82	7.85	7.79	9.00
350	8.28	8.32	8.26	9.09	9.11	9.07	8.23	8.25	8.21	8.34	8.36	8.32	8.25	8.27	8.23	8.28	8.29	8.26	7.89	7.91	7.88	7.88	7.82	7.82	7.82	7.78	9.02
355	8.25	8.28	8.21	9.07	9.09	9.05	8.21	8.23	8.19	8.33	8.35	8.31	8.20	8.22	8.23	8.28	8.25	8.22	7.88	7.90	7.86	7.84	7.82	7.80	7.82	7.78	9.01
360	8.22	8.25	8.18	9.05	9.08	9.04	8.20	8.22	8.18	8.31	8.33	8.29	8.22	8.24	8.24	8.29	8.26	8.24	7.87	7.89	7.85	7.84	7.82	7.80	7.82	7.78	9.01
365	8.19	8.22	8.16	9.04	9.06	9.02	8.19	8.21	8.17	8.30	8.32	8.28	8.18	8.20	8.16	8.26	8.24	8.24	7.86	7.88	7.84	7.84	7.82	7.80	7.82	7.78	9.01
370	8.14	8.18	8.10	9.03	9.07	9.03	8.29	8.17	8.19	8.15	8.27	8.29	8.25	8.30	8.32	8.28	8.24	8.28	7.83	7.85	7.81	7.81	7.81	7.81	7.73	8.97	8.94
375	8.12	8.16	8.11	9.00	9.03	8.97	8.16	8.19	8.13	8.27	8.30	8.24	8.32	8.35	8.29	8.23	8.25	8.25	7.82	7.85	7.82	7.85	7.79	7.82	7.78	7.73	8.96
380	8.08	8.12	8.05	8.98	9.01	8.95	8.15	8.18	8.12	8.25	8.28	8.22	8.28	8.31	8.25	8.28	8.18	8.21	7.82	7.85	7.79	7.82	7.80	7.82	7.78	7.73	8.95
385	8.07	8.08	8.04	8.96	9.00	8.92	8.14	8.18	8.10	8.24	8.28	8.20	8.22	8.26	8.18	8.21	8.25	8.17	7.80	7.84	7.76	7.80	7.76	7.79	7.72	7.71	8.95
390	8.05	8.06	8.00	8.95	8.99	8.92	8.13	8.16	8.10	8.22	8.26	8.20	8.19	8.22	8.28	8.21	8.18	8.24	7.82	7.86	7.78	7.82	7.78	7.81	7.77	7.71	8.94
395	8.02	8.05	7.98	8.92	8.96	8.89	8.12	8.15	8.09	8.21	8.24	8.18	8.33	8.36	8.30	8.27	8.19	8.21	7.81	7.85	7.77	7.81	7.75	7.85	7.73	7.70	8.93
400	8.02	8.02	7.97	8.91	8.93	8.88	8.11	8.13	8.08	8.20	8.22	8.18	8.33	8.36	8.30	8.27	8.19	8.21	7.81	7.85	7.77	7.81	7.75	7.85	7.73	7.70	8.93
405	8.02	8.02	7.97	8.91	8.93	8.88	8.11	8.13	8.08	8.20	8.22	8.18	8.33	8.36	8.30	8.27	8.19	8.21	7.81	7.85	7.77	7.81	7.75	7.85	7.73	7.70	8.93
410	7.99	8.02	7.92	8.90	8.93	8.87	8.11	8.14	8.09	8.19	8.22	8.16	8.29	8.32	8.26	8.28	8.16	8.28	7.79	7.83	7.75	7.79	7.73	7.83	7.71	7.74	8.93
415	7.97	7.98	7.93	8.88	8.91	8.85	8.10	8.13	8.07	8.19	8.22	8.16	8.28	8.31	8.25	8.28	8.16	8.28	7.78	7.82	7.74	7.78	7.72	7.82	7.70	7.74	8.93
420	7.97	7.98	7.93	8.87	8.91	8.85	8.10	8.13	8.07	8.19	8.22	8.16	8.28	8.31	8.25	8.28	8.16	8.28	7.78	7.82	7.74	7.78	7.72	7.82	7.70	7.74	8.93
425	7.97	7.98	7.93	8.87	8.91	8.85	8.10	8.13	8.07	8.19	8.22	8.16	8.28	8.31	8.25	8.28	8.16	8.28	7.78	7.82	7.74	7.78	7.72	7.82	7.70	7.74	8.93
430	7.96	7.99	7.91	8.85	8.87	8.83	8.09	8.11	8.07	8.17	8.19	8.15	8.27	8.29	8.23	8.25	8.16	8.18	7.73	7.75	7.75	7.75	7.75	7.75	7.67	7.71	8.92
435	7.94	7.97	7.91	8.84	8.86	8.82	8.09	8.11	8.07	8.16	8.18	8.14	8.29	8.31	8.27	8.15	8.17	8.13	7.73	7.75	7.75	7.71	7.71	7.69	7.71	7.67	8.91
440	7.93	7.94	7.91	8.83	8.85	8.81	8.08	8.10	8.06	8.16	8.18	8.14	8.29	8.31	8.27	8.15	8.17	8.13	7.73	7.75	7.75	7.71	7.71	7.69	7.71	7.67	8.91
445	7.92	7.93	7.89	8.82	8.86	8.78	8.08	8.12	8.04	8.15	8.19	8.11	8.27	8.31	8.23	8.14	8.18	8.10	7.72	7.76	7.68	7.68	7.62	7.68	7.62	7.64	8.91
450	7.91	7.95	7.87	8.81	8.85	8.79	8.07	8.09	8.05	8.14	8.16	8.12	8.26	8.28	8.24	8.14	8.16	8.12	7.72	7.74	7.70	7.74	7.67	7.67	7.66	7.66	8.92
455	7.89	7.93	7.87	8.79	8.82	8.76	8.07	8.10	8.04	8.13	8.16	8.10	8.24	8.27	8.21	8.13	8.16	8.10	7.72	7.74	7.70	7.74	7.67	7.67	7.66	7.66	8.92
460	7.88	7.92	7.82	8.78	8.81	8.75	8.07	8.10	8.04	8.13	8.16	8.10	8.24	8.27	8.21	8.13	8.16	8.10	7.72	7.74	7.70	7.74	7.67	7.67	7.66	7.66	8.92
465	7.89	7.91	7.84	8.77	8.81	8.73	8.08	8.10	8.02	8.12	8.16	8.08	8.26	8.30	8.22	8.12	8.16	8.09	7.70	7.73	7.68	7.67	7.67	7.63	7.63	7.63	8.91
470	7.87	7.88	7.86	8.77	8.80	8.74	8.06	8.09	8.03	8.12	8.15	8.08	8.21	8.24	8.18	8.12	8.15	8.09	7.70	7.73	7.67	7.67	7.63	7.63	7.63	7.63	8.91
475	7.87	7.92	7.83	8.75	8.77	8.73	8.08	8.04	8.11	8.13	8.09	8.20	8.22	8.18	8.11	8.13	8.09	7.68	7.70	7.66	7.66	7.62	7.66	7.62	7.62	7.62	8.91
480	7.86	7.90	7.83	8.74	8.77	8.71	8.05	8.08	8.02	8.11	8.14	8.05	8.23	8.32	8.26	8.10	8.13	8.09	7.66	7.68	7.64	7.64	7.62	7.66	7.62	7.62	8.91
485	7.85	7.88	7.83	8.73	8.75	8.71	8.05	8.07	8.03	8.10	8.12	8.08	8.20	8.22	8.18	8.10	8.12	8.08	7.68	7.70	7.66	7.66	7.62	7.66	7.62	7.62	8.91
490	7.84	7.85	7.80	8.72	8.75	8.69	8.05	8.08	8.02	8.10	8.13	8.07	8.00	8.03	7.97	8.10	8.12	8.06	7.67	7.70	7.64	7.64	7.62	7.66	7.62	7.62	8.91
495	7.83	7.84	7.79	8.71	8.74	8.68	8.05	8.08	8.02	8.10	8.13	8.07	8.00	8.03	7.97	8.10	8.12	8.06	7.67	7.70	7.64	7.64	7.62	7.66	7.62	7.62	8.91
500	7.83	7.87	7.80	8.71	8.73	8.69	8.04	8.06	8.02	8.09	8.11	8.07	8.23	8.26	8.21	8.09	8.11	8.07	7.67	7.69	7.65	7.65	7.62	7.66	7.62	7.62	8.91
505	7.82	7.85	7.75	8.69	8.71	8.67	8.04	8.06	8.02	8.08	8.10	8.06	8.21	8.23	8.19	8.08	8.10	8.06	7.66	7.68	7.64	7.64	7.62	7.66	7.62	7.62	8.91
510	7.82	7.85	7.75	8.69	8.71	8.67	8.04	8.06	8.02	8.08	8.10	8.06	8.21	8.23	8.19	8.08	8.10	8.06	7.66	7.68	7.64	7.64	7.62	7.66	7.62	7.62	

pH of Sample at different Arbitrary Concentrations and 60mg Orlistat (pH +/- 0.02)

Time (sec)	1	1	1	0.9	0.9	0.8	0.8	0.8	0.7	0.7	0.7	0.6	0.6	0.6	0.5	0.5	0.5	0.4	0.4	0.4	0.3	0.3	0.3	0.2	0.2	0.2	0.1	0.1	0.1	
560	7.77	7.80	7.76	8.61	8.59	7.99	8.01	7.97	8.03	8.06	8.00	8.12	8.14	8.15	8.05	8.07	8.03	7.63	7.65	7.61	8.51	8.53	8.49	7.60	7.62	7.58	8.81	8.83	8.79	
565	7.77	7.80	7.73	8.60	8.63	7.99	8.02	7.96	8.03	8.06	8.00	8.12	8.14	8.15	8.09	8.05	8.08	8.02	7.62	7.67	7.59	8.52	8.55	8.49	7.60	7.63	7.57	8.81	8.84	8.78
570	7.75	7.76	7.72	8.59	8.62	7.98	8.01	7.95	8.03	8.06	8.00	8.05	8.08	8.02	8.04	8.07	8.01	7.63	7.68	7.60	8.50	8.53	8.47	7.60	7.63	7.57	8.81	8.84	8.78	
575	7.75	7.80	7.73	8.59	8.61	7.98	8.00	7.96	8.02	8.04	8.00	8.03	8.05	8.02	8.02	8.06	8.02	7.62	7.64	7.64	8.50	8.52	8.48	7.60	7.62	7.58	8.79	8.81	8.77	
580	7.75	7.78	7.71	8.58	8.60	7.98	8.00	7.96	8.02	8.04	8.00	8.19	8.21	8.17	8.04	8.06	8.02	7.61	7.63	7.59	8.50	8.52	8.48	7.59	7.61	7.57	8.80	8.82	8.78	
585	7.75	7.78	7.71	8.57	8.59	7.97	7.98	7.95	8.01	8.03	7.99	8.11	8.13	8.09	8.03	8.05	8.01	7.62	7.64	7.62	8.50	8.52	8.48	7.59	7.61	7.57	8.80	8.82	8.78	
590	7.75	7.76	7.72	8.57	8.59	7.97	7.98	7.95	8.01	8.03	7.99	8.11	8.13	8.09	8.03	8.05	8.01	7.62	7.63	7.59	8.50	8.52	8.48	7.57	7.59	7.55	8.79	8.81	8.77	
595	7.74	7.76	7.72	8.57	8.61	7.97	8.01	7.95	8.03	8.06	7.97	8.12	8.16	8.08	8.03	8.07	7.99	7.60	7.64	7.56	8.49	8.53	8.45	7.59	7.63	7.55	8.79	8.83	8.75	
600	7.74	7.78	7.70	8.56	8.58	7.94	7.97	7.95	8.00	8.02	7.98	8.13	8.15	8.11	8.03	8.05	8.01	7.61	7.63	7.58	8.49	8.51	8.47	7.58	7.60	7.56	8.79	8.81	8.77	
605	7.73	7.76	7.72	8.55	8.57	7.96	7.99	7.93	8.02	8.04	7.96	8.13	8.16	8.10	8.02	8.05	7.98	7.61	7.64	7.58	8.49	8.52	8.46	7.58	7.61	7.55	8.79	8.82	8.76	
610	7.73	7.78	7.69	8.54	8.57	7.96	7.99	7.93	8.02	8.04	7.96	8.13	8.16	8.10	8.02	8.05	7.99	7.60	7.63	7.57	8.49	8.52	8.46	7.58	7.61	7.55	8.79	8.82	8.76	
615	7.73	7.78	7.70	8.54	8.58	7.95	7.99	7.93	8.01	7.99	8.03	8.17	8.19	8.17	8.09	8.02	8.06	7.58	7.64	7.56	8.48	8.52	8.44	7.58	7.62	7.54	8.78	8.82	8.74	
620	7.72	7.73	7.70	8.53	8.56	7.95	7.98	7.92	7.98	8.01	7.95	8.11	8.14	8.08	8.02	8.05	7.99	7.60	7.63	7.57	8.48	8.51	8.45	7.57	7.60	7.54	8.78	8.81	8.75	
625	7.72	7.71	7.68	8.53	8.55	7.95	7.97	7.93	7.97	7.99	7.95	7.92	7.94	7.90	8.01	8.03	7.99	7.60	7.62	7.58	8.48	8.50	8.46	7.57	7.59	7.55	8.78	8.80	8.76	
630	7.72	7.76	7.68	8.52	8.55	7.94	7.97	7.91	7.97	7.99	7.95	7.92	7.94	7.90	8.01	8.04	7.98	7.59	7.62	7.56	8.47	8.50	8.44	7.57	7.60	7.54	8.77	8.80	8.74	
635	7.71	7.74	7.69	8.52	8.54	7.94	7.96	7.92	7.97	7.99	7.95	8.15	8.17	8.13	8.00	8.02	7.96	7.59	7.61	7.57	8.47	8.49	8.45	7.56	7.58	7.54	8.78	8.80	8.76	
640	7.71	7.72	7.64	8.51	8.54	7.94	7.97	7.91	7.97	7.99	7.94	8.15	8.18	8.12	8.00	8.03	7.97	7.58	7.61	7.55	8.47	8.50	8.44	7.56	7.59	7.53	8.77	8.80	8.74	
645	7.71	7.72	7.67	8.51	8.54	7.93	7.96	7.90	7.96	7.99	7.93	8.10	8.13	8.07	8.00	8.03	7.97	7.59	7.62	7.56	8.47	8.50	8.44	7.56	7.59	7.53	8.77	8.80	8.74	
650	7.70	7.74	7.69	8.49	8.51	7.93	7.95	7.91	7.95	7.97	7.94	8.10	8.12	8.06	7.98	8.01	7.97	7.58	7.60	7.56	8.46	8.48	8.44	7.56	7.58	7.54	8.77	8.80	8.74	
655	7.70	7.73	7.66	8.49	8.51	7.93	7.95	7.91	7.95	7.97	7.93	8.33	8.35	8.31	7.99	8.01	7.97	7.58	7.60	7.56	8.45	8.47	8.43	7.55	7.57	7.53	8.76	8.78	8.74	
660	7.69	7.72	7.66	8.49	8.51	7.92	7.94	7.90	7.95	7.97	7.93	8.30	8.32	8.28	7.98	8.01	7.97	7.58	7.60	7.56	8.46	8.48	8.44	7.55	7.57	7.53	8.75	8.77	8.73	
665	7.69	7.72	7.67	8.49	8.51	7.92	7.94	7.90	7.95	7.97	7.93	8.35	8.37	8.33	7.98	8.01	7.97	7.57	7.59	7.55	8.45	8.47	8.43	7.55	7.57	7.53	8.75	8.77	8.73	
670	7.69	7.70	7.65	8.48	8.52	7.91	7.95	7.87	7.94	7.96	7.90	8.36	8.40	8.32	7.98	8.02	7.94	7.57	7.59	7.55	8.45	8.49	8.41	7.55	7.59	7.51	8.75	8.79	8.71	
675	7.69	7.74	7.65	8.47	8.49	7.93	7.95	7.91	7.93	7.95	7.91	8.39	8.41	8.37	7.98	8.00	7.96	7.57	7.59	7.55	8.45	8.49	8.43	7.55	7.57	7.53	8.75	8.79	8.71	
680	7.68	7.72	7.65	8.47	8.50	7.94	7.94	7.88	7.92	7.95	7.89	8.37	8.40	8.34	7.97	8.00	7.94	7.57	7.60	7.54	8.42	8.45	8.39	7.54	7.57	7.51	8.75	8.78	8.72	
685	7.68	7.71	7.61	8.46	8.49	7.93	7.93	7.87	7.91	7.93	7.89	8.40	8.34	8.30	7.97	8.00	7.94	7.57	7.59	7.53	8.44	8.47	8.41	7.54	7.57	7.51	8.74	8.77	8.71	
690	7.67	7.68	7.63	8.46	8.50	7.94	7.94	7.88	7.92	7.95	7.89	8.35	8.39	8.31	7.97	8.01	7.93	7.56	7.58	7.52	8.44	8.48	8.40	7.54	7.58	7.50	8.74	8.78	8.70	
695	7.67	7.68	7.66	8.45	8.48	7.93	7.93	7.87	7.92	7.95	7.89	8.36	8.39	8.33	7.97	8.00	7.94	7.56	7.58	7.53	8.43	8.46	8.40	7.54	7.57	7.51	8.74	8.77	8.71	
700	7.67	7.71	7.63	8.45	8.47	7.93	7.93	7.87	7.91	7.93	7.89	8.37	8.39	8.33	7.98	8.01	7.95	7.56	7.58	7.53	8.44	8.46	8.42	7.56	7.56	7.52	8.74	8.76	8.72	
705	7.67	7.70	7.64	8.45	8.48	7.92	7.92	7.86	7.91	7.94	7.88	8.34	8.37	8.30	7.97	8.00	7.94	7.56	7.58	7.53	8.43	8.46	8.40	7.53	7.56	7.50	8.73	8.76	8.72	
710	7.66	7.69	7.64	8.44	8.46	7.89	7.91	7.87	7.90	7.92	7.88	8.24	8.26	8.22	7.97	7.99	7.95	7.55	7.57	7.53	8.42	8.44	8.40	7.53	7.55	7.51	8.73	8.75	8.71	
715	7.66	7.69	7.62	8.44	8.47	7.89	7.92	7.86	7.90	7.93	7.87	8.27	8.30	8.24	7.96	7.98	7.93	7.55	7.58	7.52	8.42	8.45	8.39	7.53	7.53	7.50	8.73	8.75	8.70	
720	7.65	7.68	7.61	8.43	8.46	7.88	7.91	7.85	7.90	7.93	7.87	8.27	8.30	8.24	7.96	7.99	7.93	7.55	7.58	7.52	8.42	8.45	8.39	7.53	7.53	7.50	8.73	8.75	8.69	
725	7.65	7.70	7.62	8.43	8.45	7.88	7.90	7.86	7.89	7.91	7.87	8.19	8.21	8.17	7.96	7.98	7.94	7.54	7.56	7.52	8.42	8.44	8.40	7.52	7.54	7.50	8.73	8.75	8.71	
730	7.65	7.69	7.59	8.42	8.44	7.88	7.90	7.86	7.89	7.91	7.87	8.21	8.23	8.19	7.96	7.98	7.94	7.54	7.56	7.52	8.42	8.44	8.40	7.52	7.54	7.50	8.73	8.75	8.71	
735	7.65	7.68	7.61	8.42	8.44	7.87	7.89	7.85	7.88	7.90	7.86	8.16	8.18	8.14	7.95	7.97	7.93	7.54	7.56	7.52	8.42	8.44	8.40	7.52	7.54	7.50	8.72	8.74	8.70	
740	7.64	7.65	7.63	8.42	8.44	7.87	7.89	7.85	7.88	7.90	7.86	8.22	8.24	8.20	7.96	7.98	7.94	7.54	7.56	7.52	8.42	8.44	8.40	7.52	7.54	7.50	8.73	8.75	8.71	
745	7.64	7.65	7.60	8.42	8.46	7.91	7.91	7.83	7.88	7.92	7.84	8.17	8.21	8.13	7.95	7.99	7.91	7.54	7.58	7.50	8.42	8.46	8.38	7.52	7.56	7.48	8.72	8.76	8.68	
750	7.64	7.68	7.61	8.41	8.43	7.86	7.88	7.84	7.87	7.89	7.85	8.25	8.27	8.23	7.95	7.97	7.93	7.54	7.56	7.52	8.41	8.43	8.39	7.52	7.54	7.50	8.72	8.74	8.70	
755	7.63	7.68	7.61	8.41	8.44	7.86	7.89	7.82	7.87	7.90	7.84	8.18	8.21	8.15	7.94	7.97	7.91	7.53	7.55	7.50	8.40	8.43	8.37	7.52	7.55	7.49	8.72	8.75	8.69	
760	7.63	7.66	7.59	8.40	8.43	7.85	7.87	7.83	7.87	7.90	7.84	8.23	8.26	8.20	7.94	7.97	7.91	7.53	7.55	7.50	8.41	8.44	8.38	7.51	7.54	7.48	8.72	8.75	8.69	
765	7.63	7.66	7.59	8.40	8.44	7.86	7.86	7.80	7.82	7.87	7.91	8.23	8.25	8.23	7.94	7.98	7.90	7.53	7.57	7.49	8.40	8.44	8.36	7.51	7.55	7.47	8.72	8.75	8.68	
770	7.63	7.64	7.60	8.40	8.43	7.85	7.88	7.82	7.87	7.90	7.84	8.21	8.24	8.19	7.94	7.98	7.90	7.53	7.57	7.49	8.40	8.43	8.37	7.51	7.54	7.48	8.72	8.75	8.69	
775	7.62	7.67	7.55	8.40	8.42	7.83	7.85	7.81	7.83	7.86	7.84	8.21	8.24	8.19	7.94	7.97	7.91	7.52	7.55	7.48	8.40	8.43	8.							

pH of Sample at different Arbitrary Concentrations and 60mg Orlistat (pH +/- 0.02)

Time (sec)	1	1	1	0.9	0.9	0.9	0.8	0.8	0.8	0.7	0.7	0.7	0.6	0.6	0.6	0.5	0.5	0.5	0.4	0.4	0.4	0.4	0.3	0.3	0.3	0.2	0.2	0.2	0.1	0.1	0.1
840	7.60	7.61	7.57	8.35	8.39	8.31	7.81	7.89	7.77	7.82	7.86	7.78	8.12	8.16	8.08	7.91	7.95	7.87	7.51	7.55	7.47	7.47	8.37	8.41	8.33	7.49	7.53	7.45	8.69	8.73	8.65
845	7.59	7.60	7.57	8.35	8.36	8.32	7.81	7.84	7.78	7.82	7.85	7.79	8.16	8.19	8.13	7.91	7.94	7.88	7.50	7.53	7.47	7.48	8.37	8.40	8.34	7.48	7.51	7.45	8.69	8.71	8.65
850	7.59	7.63	7.56	8.34	8.36	8.32	7.81	7.83	7.79	7.82	7.84	7.80	8.20	8.22	8.18	7.91	7.93	7.89	7.50	7.52	7.46	7.46	8.37	8.39	8.33	7.48	7.51	7.45	8.69	8.71	8.65
855	7.59	7.62	7.55	8.35	8.38	8.32	7.80	7.83	7.77	7.82	7.85	7.79	8.16	8.19	8.13	7.90	7.93	7.87	7.49	7.52	7.46	7.46	8.36	8.39	8.33	7.48	7.51	7.45	8.69	8.71	8.65
860	7.59	7.62	7.56	8.34	8.36	8.32	7.80	7.82	7.78	7.82	7.84	7.80	8.08	8.10	8.06	7.90	7.92	7.86	7.50	7.52	7.46	7.46	8.37	8.39	8.35	7.47	7.49	7.45	8.69	8.71	8.65
865	7.58	7.61	7.51	8.34	8.37	8.31	7.80	7.83	7.77	7.82	7.85	7.79	8.03	8.03	7.97	7.80	7.83	7.87	7.49	7.52	7.46	7.46	8.37	8.40	8.34	7.47	7.50	7.44	8.69	8.71	8.65
870	7.58	7.59	7.54	8.34	8.37	8.31	7.80	7.83	7.77	7.82	7.85	7.79	8.03	8.03	7.97	7.80	7.83	7.87	7.49	7.52	7.46	7.46	8.37	8.40	8.34	7.47	7.50	7.44	8.67	8.70	8.64
875	7.58	7.63	7.57	8.33	8.35	8.31	7.80	7.82	7.78	7.82	7.84	7.80	8.08	8.10	8.06	7.90	7.92	7.88	7.49	7.51	7.47	7.47	8.36	8.38	8.34	7.47	7.49	7.45	8.67	8.69	8.65
880	7.58	7.62	7.54	8.33	8.35	8.31	7.80	7.82	7.78	7.82	7.84	7.80	8.08	8.10	8.06	7.90	7.92	7.88	7.49	7.51	7.47	7.47	8.36	8.38	8.34	7.47	7.49	7.45	8.67	8.69	8.65
885	7.57	7.60	7.54	8.32	8.35	8.31	7.79	7.81	7.77	7.82	7.84	7.80	8.05	8.07	8.03	7.90	7.92	7.88	7.48	7.51	7.47	7.47	8.35	8.38	8.34	7.47	7.49	7.45	8.67	8.69	8.65
890	7.57	7.58	7.53	8.32	8.34	8.30	7.79	7.81	7.77	7.82	7.84	7.80	8.05	8.08	8.04	7.89	7.91	7.87	7.48	7.50	7.46	7.46	8.35	8.37	8.33	7.47	7.49	7.45	8.67	8.69	8.65
895	7.57	7.59	7.53	8.32	8.36	8.28	7.79	7.83	7.75	7.81	7.85	7.77	8.07	8.11	8.03	7.89	7.93	7.85	7.48	7.52	7.44	7.44	8.35	8.39	8.31	7.46	7.50	7.42	8.66	8.70	8.62
900	7.57	7.61	7.53	8.32	8.34	8.30	7.79	7.81	7.77	7.81	7.83	7.79	8.02	8.04	8.00	7.89	7.91	7.87	7.49	7.51	7.47	7.47	8.35	8.37	8.33	7.46	7.48	7.44	8.66	8.68	8.64

Table 1.3

pH of Sample at different Arbitrary Concentrations and 120mg Orlistat (pH +/- 0.02)

Time (sec)	1	1	1	0.9	0.9	0.8	0.8	0.8	0.7	0.7	0.7	0.6	0.6	0.6	0.5	0.5	0.5	0.4	0.4	0.4	0.3	0.3	0.3	0.2	0.2	0.2	0.1	0.1	0.1			
0	9.89	9.61	9.87	9.22	9.24	9.20	9.86	10.00	9.86	11.09	11.11	11.07	9.16	9.18	9.14	9.41	9.43	9.39	9.49	9.51	9.47	9.56	9.58	9.54	9.51	9.53	9.49	9.50	9.62	9.78		
5	9.84	9.67	9.81	9.19	9.22	9.16	9.96	9.99	9.93	11.06	11.09	11.03	9.14	9.17	9.11	9.35	9.38	9.32	9.50	9.53	9.47	9.53	9.56	9.50	9.06	9.09	9.03	9.76	9.79	9.73		
10	9.83	9.66	9.80	9.17	9.20	9.14	9.91	9.94	9.86	11.04	11.07	11.01	9.12	9.15	9.09	9.31	9.34	9.28	9.48	9.48	9.45	9.47	9.50	9.44	9.33	9.36	9.30	9.48	9.51	9.45		
15	9.83	9.67	9.79	9.15	9.19	9.11	9.89	9.93	9.85	11.03	11.07	10.98	9.10	9.14	9.08	9.32	9.34	9.24	9.48	9.52	9.44	9.43	9.47	9.39	9.36	9.30	9.34	9.34	9.38	9.30		
20	9.82	9.65	9.78	9.14	9.17	9.11	9.89	9.92	9.85	11.01	11.04	10.98	9.09	9.12	9.06	9.23	9.26	9.20	9.46	9.49	9.42	9.43	9.46	9.40	9.32	9.35	9.28	9.28	9.23	9.23		
25	9.80	9.62	9.78	9.13	9.15	9.11	9.88	9.90	9.86	11.02	10.98	11.02	9.08	9.10	9.06	9.20	9.22	9.18	9.46	9.44	9.44	9.44	9.46	9.40	9.32	9.35	9.28	9.21	9.23	9.19		
30	9.79	9.62	9.76	9.12	9.15	9.09	9.87	9.90	9.84	10.99	11.02	10.96	9.06	9.09	9.03	9.18	9.21	9.15	9.45	9.48	9.44	9.44	9.46	9.40	9.32	9.35	9.28	9.21	9.23	9.19		
35	9.76	9.78	9.74	9.12	9.14	9.10	9.85	9.87	9.83	10.97	10.99	10.95	9.05	9.07	9.03	9.18	9.20	9.16	9.43	9.45	9.41	9.42	9.44	9.40	9.32	9.35	9.28	9.21	9.23	9.14		
40	9.76	9.79	9.73	9.10	9.13	9.07	9.84	9.87	9.81	10.96	10.99	10.93	9.04	9.07	9.01	9.16	9.19	9.13	9.42	9.45	9.39	9.40	9.43	9.37	9.39	9.32	9.25	9.15	9.14	9.08		
45	9.75	9.78	9.72	9.09	9.12	9.06	9.86	9.89	9.83	10.95	10.98	10.92	9.03	9.06	9.00	9.16	9.19	9.13	9.40	9.43	9.37	9.39	9.42	9.36	9.39	9.32	9.25	9.15	9.14	9.08		
50	9.75	9.77	9.73	9.08	9.11	9.07	9.82	9.84	9.80	10.91	10.93	10.89	9.02	9.04	9.00	9.15	9.17	9.13	9.39	9.41	9.37	9.32	9.34	9.36	9.32	9.25	9.15	9.14	9.08	9.03		
55	9.71	9.73	9.69	9.08	9.10	9.06	9.77	9.79	9.75	10.91	10.93	10.89	9.00	9.02	9.00	9.15	9.17	9.13	9.37	9.39	9.35	9.35	9.37	9.33	9.30	9.25	9.10	9.12	9.08	9.03		
60	9.69	9.71	9.67	9.07	9.09	9.05	9.76	9.78	9.74	10.90	10.92	10.88	8.99	9.01	8.97	9.15	9.17	9.13	9.35	9.37	9.33	9.33	9.29	9.31	9.27	9.20	9.09	9.11	9.07	9.02		
65	9.70	9.72	9.68	9.06	9.08	9.04	9.76	9.78	9.74	10.89	10.91	10.87	8.97	8.99	8.95	9.14	9.16	9.12	9.33	9.35	9.31	9.24	9.26	9.22	9.22	9.19	9.03	9.05	9.01	8.99	8.98	
70	9.68	9.72	9.64	9.05	9.08	9.01	9.73	9.77	9.69	10.88	10.92	10.84	8.96	9.00	8.92	9.13	9.17	9.08	9.31	9.35	9.27	9.23	9.27	9.23	9.27	9.19	9.03	9.05	9.01	8.99	8.98	
75	9.63	9.63	9.61	9.03	9.05	9.01	9.71	9.73	9.69	10.88	10.90	10.86	8.95	8.97	8.93	9.14	9.16	9.12	9.28	9.30	9.26	9.22	9.24	9.20	9.20	9.16	8.82	8.84	8.80	8.83	8.77	
80	9.61	9.64	9.58	9.02	9.05	8.99	9.69	9.72	9.66	10.87	10.84	10.83	8.93	8.96	8.90	9.13	9.16	9.10	9.24	9.27	9.21	9.16	9.19	9.13	9.16	9.08	8.82	8.80	8.83	8.77	8.71	
85	9.60	9.63	9.57	9.01	9.04	8.98	9.67	9.70	9.64	10.86	10.89	10.83	8.92	8.95	8.89	9.12	9.15	9.09	9.22	9.25	9.19	9.14	9.17	9.11	9.14	9.06	8.82	8.80	8.83	8.77	8.71	
90	9.59	9.63	9.55	9.00	9.04	8.96	9.71	9.75	9.67	10.85	10.89	10.81	8.90	8.94	8.86	9.12	9.16	9.08	9.19	9.23	9.15	9.08	9.12	9.04	9.08	8.92	8.84	8.82	8.74	8.71	8.68	
95	9.57	9.60	9.54	8.99	9.02	8.96	9.64	9.67	9.61	10.84	10.87	10.81	8.89	8.92	8.86	9.11	9.14	9.08	9.16	9.19	9.13	9.05	9.08	9.02	8.96	8.83	8.70	8.73	8.67	8.63	8.59	
100	9.57	9.59	9.55	8.98	9.00	8.96	9.62	9.64	9.60	10.83	10.83	10.81	8.87	8.89	8.85	9.10	9.12	9.08	9.13	9.15	9.11	9.02	9.04	8.90	8.83	8.70	8.73	8.67	8.63	8.59	8.54	
105	9.54	9.57	9.51	8.96	8.98	8.93	9.59	9.62	9.56	10.82	10.85	10.79	8.87	8.90	8.84	9.08	9.12	9.06	9.09	9.12	9.06	8.94	8.87	8.81	8.70	8.73	8.67	8.63	8.59	8.54	8.48	
110	9.54	9.56	9.52	8.95	8.97	8.93	9.56	9.58	9.54	10.81	10.83	10.79	8.84	8.86	8.82	9.08	9.10	9.06	9.06	9.08	9.04	8.88	8.80	8.66	8.27	8.29	8.25	8.67	8.63	8.59	8.54	
115	9.53	9.56	9.50	8.94	8.97	8.91	9.57	9.60	9.54	10.80	10.83	10.77	8.83	8.86	8.80	9.07	9.10	9.04	9.02	9.05	9.09	8.96	8.89	8.69	8.25	8.28	8.22	8.68	8.71	8.65	8.60	
120	9.52	9.55	9.49	8.93	8.96	8.90	9.55	9.58	9.52	10.78	10.81	10.75	8.82	8.85	8.79	9.07	9.10	9.04	9.09	9.02	9.06	8.94	8.87	8.69	8.22	8.25	8.19	8.57	8.60	8.54	8.49	
125	9.47	9.49	9.45	8.91	8.93	8.88	9.51	9.53	9.49	10.77	10.80	10.75	8.80	8.82	8.78	9.05	9.07	9.03	9.08	9.08	9.04	8.81	8.63	8.79	8.19	8.21	8.17	8.67	8.69	8.65	8.59	
130	9.46	9.47	9.43	8.90	8.92	8.88	9.52	9.54	9.50	10.76	10.79	10.74	8.80	8.82	8.78	9.04	9.06	9.02	9.02	9.04	9.00	8.73	8.75	8.71	8.16	8.18	8.14	8.61	8.63	8.59	8.54	
135	9.44	9.46	9.42	8.88	8.90	8.86	9.46	9.48	9.44	10.74	10.75	10.71	8.78	8.80	8.76	9.03	9.05	9.01	9.01	9.03	8.87	8.72	8.64	8.66	8.62	8.11	8.13	8.09	8.49	8.51	8.47	
140	9.41	9.43	9.39	8.88	8.90	8.86	9.44	9.46	9.42	10.73	10.75	10.71	8.78	8.80	8.76	9.02	9.04	9.00	9.00	9.02	8.85	8.67	8.63	8.64	8.66	8.62	8.11	8.13	8.09	8.49	8.51	8.47
145	9.41	9.45	9.37	8.87	8.91	8.83	9.43	9.47	9.39	10.72	10.76	10.68	8.76	8.80	8.72	9.02	9.06	9.06	9.06	9.08	8.84	8.76	8.65	8.69	8.61	8.09	8.12	8.04	8.48	8.52	8.44	
150	9.36	9.36	9.34	8.85	8.87	8.83	9.40	9.42	9.38	10.70	10.72	10.68	8.75	8.77	8.73	9.01	9.03	9.03	9.03	9.05	8.89	8.78	8.74	8.57	8.59	8.55	8.07	8.03	8.53	8.56	8.51	
155	9.48	9.51	9.45	8.83	8.86	8.80	9.39	9.42	9.36	10.69	10.72	10.66	8.73	8.76	8.70	9.00	9.03	9.03	9.03	9.05	8.89	8.68	8.59	8.62	8.56	8.00	8.00	8.49	8.52	8.46	8.46	
160	9.51	9.54	9.48	8.82	8.85	8.79	9.36	9.39	9.33	10.68	10.71	10.65	8.72	8.75	8.69	8.98	9.01	8.95	8.95	8.97	8.69	8.63	8.59	8.61	8.55	8.01	8.04	7.88	8.47	8.50	8.44	
165	9.46	9.50	9.42	8.80	8.84	8.76	9.41	9.45	9.37	10.66	10.70	10.62	8.70	8.74	8.66	8.97	9.01	8.93	8.61	8.65	8.57	8.54	8.58	8.50	7.99	8.03	7.95	8.58	8.60	8.52	8.46	
170	9.45	9.48	9.42	8.79	8.82	8.76	9.42	9.45	9.39	10.65	10.68	10.62	8.69	8.72	8.66	8.97	9.00	8.94	8.56	8.59	8.53	8.47	8.50	8.44	7.97	8.00	7.94	8.56	8.59	8.53	8.47	
175	9.42	9.44	9.40	8.78	8.80	8.76	9.44	9.46	9.42	10.64	10.66	10.62	8.68	8.70	8.66	8.94	8.96	8.92	8.50	8.52	8.48	8.45	8.47	8.43	7.94	7.96	7.92	8.67	8.69	8.65	8.59	
180	9.41	9.44	9.38	8.76	8.79	8.73	9.42	9.45	9.39	10.62	10.65	10.59	8.67	8.70	8.64	8.94	8.97	8.91	8.44	8.47	8.41	8.45	8.48	8.42	7.93	7.96	7.90	8.66	8.69	8.65	8.59	
185	9.40	9.42	9.38	8.75	8.77	8.73	9.40	9.43	9.38	10.61	10.63	10.59	8.66	8.68	8.64	8.93	8.95	8.91	8.39	8.41	8.37	8.45	8.47	8.43	7.91	7.93	7.89	8.55	8.57	8.53	8.47	
190	9.37	9.40	9.34	8.74	8.77	8.71	9.41	9.44	9.36	10.59	10.62	10.56	8.64	8.67	8.61	8.92	8.95	8.89	8.33	8.36	8.30	8.40	8.43	8.37	7.90	7.93	7.87	8.64	8.67	8.61	8.55	
195	9.37	9.40	9.34	8.74	8.77	8.71	9.41	9.44	9.36	10.59	10.62	10.56	8.64	8.67	8.61	8.92	8.95	8.89	8.33	8.36	8.30	8.40	8.43	8.37	7.90	7.93	7.87	8.64	8.67	8.61	8.55	
200	9.36	9.40	9.36	8.71	8.73	8.69	9.34	9.36	9.32	10.57	10.59	10.55	8.62	8.64	8.60	8.90	8.92	8.88	8.23	8.25	8.21	8.40	8.42	8.38	7.87	7.89	7.85	8.57	8.59	8.55	8.49	

pH of Sample at different Arbitrary Concentrations and 120mg Orlostat (pH +/- 0.02)

Time (sec)	1	1	1	0.9	0.9	0.9	0.8	0.8	0.8	0.7	0.7	0.7	0.6	0.6	0.6	0.5	0.5	0.5	0.4	0.4	0.4	0.3	0.3	0.3	0.2	0.2	0.2	0.1	0.1	
280	9.08	9.10	9.05	8.49	8.51	8.47	9.22	9.24	9.20	10.33	10.35	10.31	8.44	8.46	8.42	8.69	8.71	8.67	7.85	7.87	7.83	8.21	8.23	8.19	7.75	7.77	7.73	8.54	8.56	8.52
285	9.06	9.07	9.03	8.48	8.50	8.46	9.19	9.21	9.17	10.32	10.34	10.30	8.43	8.45	8.41	8.68	8.70	8.66	7.85	7.87	7.83	8.19	8.21	8.17	7.75	7.77	7.73	8.54	8.56	8.52
290	9.06	9.11	9.07	8.46	8.48	8.44	9.18	9.20	9.16	10.28	10.31	10.27	8.42	8.44	8.40	8.66	8.68	8.64	7.85	7.87	7.81	8.14	8.16	8.12	7.75	7.77	7.73	8.54	8.56	8.52
295	9.05	9.10	9.02	8.45	8.49	8.41	8.98	9.03	8.95	10.28	10.32	10.24	8.41	8.45	8.37	8.65	8.69	8.61	7.82	7.85	7.78	8.13	8.17	8.09	7.75	7.79	7.71	8.51	8.55	8.47
300	9.08	9.11	9.07	8.43	8.45	8.41	9.08	9.04	9.08	10.23	10.27	10.23	8.40	8.42	8.38	8.64	8.66	8.62	7.82	7.84	7.80	8.15	8.19	8.15	7.74	7.78	7.72	8.51	8.55	8.49
305	9.08	9.11	9.05	8.42	8.45	8.39	9.08	9.04	9.08	10.23	10.27	10.23	8.40	8.42	8.38	8.64	8.66	8.62	7.82	7.84	7.80	8.15	8.19	8.15	7.74	7.78	7.72	8.51	8.55	8.49
310	9.06	9.08	9.03	8.40	8.43	8.37	9.04	9.07	9.01	10.21	10.24	10.18	8.38	8.41	8.35	8.61	8.64	8.58	7.81	7.84	7.78	8.17	8.18	8.14	7.73	7.76	7.70	8.51	8.54	8.48
315	9.02	9.05	9.03	8.39	8.43	8.35	9.03	9.07	8.97	10.19	10.23	10.15	8.36	8.40	8.32	8.59	8.63	8.55	7.80	7.84	7.78	8.15	8.19	8.11	7.73	7.77	7.69	8.49	8.53	8.45
320	9.02	9.05	8.99	8.37	8.40	8.34	8.99	9.02	8.96	10.17	10.20	10.14	8.34	8.36	8.32	8.56	8.58	8.54	7.80	7.82	7.78	8.10	8.12	8.08	7.72	7.74	7.69	8.47	8.50	8.44
325	9.02	9.04	9.00	8.33	8.37	8.33	8.95	8.97	8.93	10.15	10.17	10.13	8.34	8.36	8.32	8.56	8.58	8.54	7.80	7.82	7.78	8.10	8.12	8.08	7.72	7.74	7.69	8.47	8.50	8.44
330	9.00	9.03	8.97	8.33	8.36	8.30	8.97	9.00	8.94	10.13	10.16	10.10	8.34	8.37	8.31	8.55	8.58	8.52	7.78	7.82	7.76	8.11	8.14	8.08	7.71	7.74	7.68	8.45	8.51	8.45
335	8.99	9.01	8.97	8.32	8.34	8.30	8.93	8.95	8.91	10.11	10.13	10.09	8.32	8.34	8.30	8.53	8.55	8.51	7.79	7.81	7.77	8.13	8.15	8.11	7.73	7.77	7.69	8.51	8.55	8.45
340	8.97	9.00	8.94	8.30	8.33	8.27	8.82	8.85	8.79	10.09	10.12	10.06	8.31	8.34	8.28	8.52	8.55	8.49	7.78	7.82	7.76	8.16	8.19	8.13	7.70	7.73	7.67	8.50	8.53	8.47
345	8.92	8.95	8.89	8.27	8.30	8.24	8.88	8.91	8.85	10.07	10.10	10.04	8.30	8.33	8.27	8.50	8.53	8.47	7.78	7.81	7.75	7.91	7.94	7.88	7.70	7.73	7.67	8.49	8.52	8.46
350	8.88	8.90	8.85	8.26	8.28	8.24	8.85	8.87	8.83	10.06	10.08	10.04	8.29	8.31	8.27	8.50	8.52	8.48	7.77	7.79	7.75	8.10	8.12	8.08	7.70	7.72	7.68	8.49	8.51	8.41
355	8.88	8.90	8.86	8.24	8.26	8.22	8.84	8.86	8.82	10.04	10.06	10.02	8.27	8.29	8.25	8.48	8.50	8.46	7.77	7.79	7.75	8.19	8.21	8.17	7.69	7.71	7.67	8.54	8.56	8.52
360	8.87	8.89	8.85	8.21	8.23	8.19	8.84	8.86	8.82	10.02	10.04	10.00	8.26	8.28	8.24	8.48	8.50	8.46	7.77	7.79	7.75	8.18	8.20	8.14	7.68	7.71	7.67	8.54	8.56	8.52
365	8.80	8.82	8.76	8.19	8.21	8.17	8.83	8.85	8.81	10.00	10.02	9.98	8.25	8.27	8.23	8.46	8.48	8.44	7.77	7.79	7.75	8.12	8.14	8.10	7.68	7.71	7.67	8.47	8.49	8.45
370	8.78	8.80	8.72	8.18	8.22	8.14	8.86	8.89	8.82	9.99	10.03	9.95	8.24	8.26	8.20	8.46	8.50	8.42	7.77	7.81	7.73	8.10	8.14	8.06	7.68	7.72	7.64	8.54	8.58	8.50
375	8.84	8.86	8.82	8.16	8.18	8.14	8.85	8.87	8.83	9.97	9.99	9.95	8.22	8.24	8.20	8.44	8.46	8.42	7.76	7.78	7.74	8.15	8.17	8.13	7.68	7.70	7.66	8.48	8.54	8.44
380	8.78	8.81	8.75	8.14	8.17	8.11	8.78	8.81	8.75	9.96	9.98	9.94	8.21	8.24	8.20	8.44	8.46	8.42	7.76	7.78	7.74	8.15	8.17	8.13	7.68	7.70	7.66	8.48	8.54	8.44
385	8.81	8.84	8.78	8.12	8.15	8.09	8.74	8.77	8.71	9.94	9.97	9.91	8.20	8.23	8.17	8.42	8.45	8.39	7.78	7.79	7.75	8.10	8.13	8.07	7.68	7.71	7.65	8.47	8.51	8.45
390	8.72	8.75	8.69	8.12	8.16	8.08	8.72	8.75	8.69	9.93	9.97	9.89	8.19	8.23	8.15	8.41	8.45	8.37	7.76	7.80	7.72	8.12	8.16	8.08	7.67	7.71	7.63	8.50	8.54	8.46
395	8.76	8.81	8.75	8.09	8.12	8.05	8.71	8.74	8.68	9.91	9.94	9.86	8.18	8.22	8.14	8.40	8.43	8.37	7.75	7.78	7.72	8.15	8.18	8.12	7.67	7.70	7.64	8.46	8.48	8.40
400	8.78	8.78	8.74	8.08	8.10	8.05	8.72	8.74	8.70	9.90	9.92	9.85	8.15	8.18	8.14	8.39	8.41	8.37	7.75	7.77	7.73	8.15	8.18	8.12	7.67	7.69	7.65	8.45	8.47	8.43
405	8.73	8.76	8.70	8.07	8.10	8.04	8.67	8.70	8.64	9.89	9.92	9.85	8.15	8.18	8.12	8.39	8.42	8.36	7.75	7.78	7.72	8.12	8.15	8.09	7.67	7.70	7.64	8.44	8.47	8.41
410	8.71	8.73	8.69	8.05	8.07	8.03	8.70	8.72	8.68	9.88	9.90	9.83	8.12	8.15	8.11	8.38	8.40	8.35	7.75	7.77	7.73	8.11	8.13	8.09	7.66	7.69	7.64	8.43	8.45	8.41
415	8.67	8.70	8.64	8.03	8.06	8.00	8.64	8.67	8.61	9.86	9.89	9.83	8.12	8.15	8.09	8.36	8.38	8.33	7.75	7.77	7.73	8.11	8.13	8.09	7.65	7.68	7.63	8.50	8.53	8.47
420	8.73	8.76	8.70	8.03	8.06	8.00	8.68	8.71	8.65	9.84	9.87	9.81	8.11	8.14	8.08	8.36	8.39	8.33	7.75	7.78	7.72	8.07	8.10	8.04	7.66	7.69	7.63	8.50	8.53	8.47
425	8.70	8.72	8.68	8.01	8.03	7.99	8.64	8.66	8.62	9.84	9.86	9.82	8.10	8.12	8.08	8.36	8.39	8.34	7.75	7.77	7.73	8.09	8.11	8.07	7.65	7.67	7.63	8.49	8.51	8.47
430	8.66	8.68	8.64	7.99	8.01	7.97	8.54	8.56	8.52	9.81	9.83	9.79	8.09	8.11	8.07	8.35	8.37	8.33	7.75	7.77	7.73	8.09	8.11	8.06	7.65	7.67	7.63	8.49	8.51	8.47
435	8.67	8.69	8.65	7.99	8.01	7.97	8.54	8.56	8.52	9.81	9.83	9.79	8.09	8.11	8.05	8.34	8.36	8.32	7.75	7.77	7.73	8.09	8.11	8.07	7.65	7.67	7.63	8.49	8.51	8.47
440	8.59	8.60	8.56	7.96	8.00	7.92	8.48	8.50	8.46	9.80	9.82	9.78	8.08	8.08	8.04	8.34	8.36	8.32	7.75	7.77	7.73	8.08	8.10	8.06	7.64	7.66	7.62	8.45	8.47	8.43
445	8.65	8.70	8.62	7.96	8.00	7.92	8.47	8.51	8.43	9.79	9.83	9.75	8.05	8.09	8.01	8.32	8.36	8.28	7.75	7.79	7.71	8.08	8.12	8.04	7.64	7.68	7.60	8.45	8.49	8.41
450	8.62	8.64	8.60	7.96	7.98	7.94	8.49	8.51	8.47	9.78	9.80	9.76	8.05	8.07	8.01	8.31	8.34	8.28	7.75	7.79	7.71	8.08	8.10	8.06	7.64	7.66	7.62	8.45	8.49	8.41
455	8.68	8.71	8.65	7.95	7.98	7.92	8.58	8.61	8.55	9.76	9.78	9.73	8.04	8.07	8.01	8.31	8.34	8.28	7.75	7.79	7.73	8.08	8.10	8.06	7.64	7.66	7.62	8.45	8.49	8.41
460	8.60	8.63	8.57	7.93	7.95	7.90	8.48	8.51	8.45	9.76	9.79	9.73	8.03	8.06	8.00	8.30	8.33	8.27	7.74	7.78	7.72	8.05	8.08	8.03	7.63	7.65	7.60	8.35	8.38	8.32
465	8.59	8.63	8.55	7.93	7.97	7.89	8.45	8.49	8.41	9.75	9.79	9.71	8.02	8.05	7.98	8.30	8.34	8.26	7.74	7.78	7.72	8.04	8.14	8.14	7.63	7.67	7.59	8.34	8.38	8.30
470	8.58	8.61	8.55	7.92	7.95	7.89	8.45	8.48	8.42	9.73	9.76	9.70	8.01	8.04	7.98	8.29	8.32	8.25	7.74	7.78	7.72	8.04	8.14	8.14	7.63	7.67	7.59	8.34	8.38	8.30
475	8.62	8.64	8.60	7.91	7.93	7.89	8.45	8.47	8.43	9.73	9.75	9.71	8.01	8.02	7.98	8.29	8.31	8.27	7.74	7.76	7.72	8.12	8.14	8.10	7.62	7.64	7.60	8.42	8.44	8.40
480	8.60	8.63	8.57	7.90	7.93	7.87	8.34	8.37	8.31	9.71	9.75	9.69	7.99	8.02	7.96	8.27	8.29	8.25	7.74	7.76	7.72	8.13	8.16	8.10	7.62	7.64	7.60	8.42	8.46	8.39
485	8.59	8.61	8.57	7.89	7.91	7.87	8.36	8.38	8.34	9.71	9.73	9.69	7.99	8.00	7.96	8.27	8.29	8.25	7.74	7.76	7.72	8.13	8.16	8.10	7.62	7.64	7.60	8.44	8.46	8.42
490	8.53	8.56	8.50	7.89	7.93	7.87																								

pH of Sample at different Arbitrary Concentrations and 120mg Orlistat (pH +/- 0.02)

Time (sec)	1	1	1	0.9	0.9	0.9	0.8	0.8	0.8	0.7	0.7	0.7	0.6	0.6	0.6	0.5	0.5	0.5	0.4	0.4	0.4	0.3	0.3	0.3	0.2	0.2	0.2	0.1	0.1	0.1
560	8.37	8.39	8.35	7.81	7.83	7.79	8.28	8.30	8.26	9.56	9.60	9.56	7.89	7.91	7.87	8.18	8.20	8.16	7.72	7.74	7.70	8.07	8.09	8.05	7.60	7.62	7.58	8.35	8.37	8.33
565	8.28	8.31	8.25	7.81	7.84	7.78	8.27	8.30	8.24	9.56	9.59	9.53	7.89	7.92	7.86	8.18	8.21	8.15	7.72	7.75	7.69	8.02	8.05	8.00	7.59	7.59	7.56	8.34	8.37	8.31
570	8.20	8.23	8.17	7.80	7.83	7.77	8.30	8.33	8.27	9.56	9.59	9.53	7.88	7.91	7.85	8.17	8.20	8.14	7.72	7.75	7.69	8.02	8.05	8.00	7.60	7.63	7.57	8.35	8.38	8.32
575	8.30	8.32	8.28	7.80	7.82	7.78	8.27	8.29	8.25	9.55	9.57	9.53	7.88	7.90	7.86	8.16	8.18	8.14	7.72	7.74	7.70	8.03	8.06	8.01	7.59	7.61	7.57	8.33	8.36	8.31
580	8.40	8.42	8.38	7.79	7.81	7.77	8.28	8.30	8.26	9.54	9.56	9.52	7.88	7.90	7.86	8.16	8.18	8.14	7.71	7.73	7.69	8.06	8.08	8.04	7.59	7.61	7.57	8.30	8.32	8.28
585	8.38	8.40	8.36	7.79	7.81	7.77	8.34	8.36	8.32	9.54	9.56	9.52	7.87	7.89	7.85	8.16	8.18	8.14	7.71	7.73	7.69	8.05	8.07	8.03	7.59	7.61	7.57	8.33	8.35	8.31
590	8.35	8.37	8.33	7.78	7.80	7.76	8.35	8.37	8.33	9.53	9.55	9.51	7.87	7.89	7.85	8.15	8.17	8.13	7.71	7.73	7.69	8.00	8.02	7.98	7.59	7.61	7.57	8.33	8.35	8.31
595	8.40	8.44	8.36	7.77	7.81	7.73	8.34	8.36	8.30	9.52	9.56	9.47	7.87	7.91	7.83	8.13	8.17	8.09	7.70	7.74	7.68	8.06	8.10	8.02	7.59	7.63	7.55	8.33	8.37	8.29
600	8.32	8.34	8.30	7.77	7.79	7.75	8.33	8.35	8.31	9.51	9.53	9.49	7.86	7.88	7.84	8.13	8.15	8.11	7.70	7.72	7.68	8.07	8.10	8.04	7.59	7.61	7.55	8.30	8.32	8.28
605	8.33	8.36	8.30	7.77	7.80	7.74	8.30	8.33	8.27	9.50	9.53	9.47	7.86	7.88	7.83	8.12	8.15	8.09	7.70	7.73	7.67	8.07	8.10	8.04	7.59	7.61	7.55	8.29	8.32	8.26
610	8.43	8.46	8.40	7.77	7.80	7.74	8.31	8.34	8.28	9.50	9.53	9.47	7.85	7.88	7.82	8.12	8.15	8.09	7.69	7.72	7.66	8.06	8.09	8.03	7.58	7.61	7.55	8.32	8.35	8.29
615	8.42	8.46	8.38	7.76	7.80	7.72	8.29	8.33	8.25	9.49	9.53	9.47	7.85	7.89	7.81	8.12	8.16	8.08	7.69	7.73	7.65	8.03	8.07	7.99	7.58	7.62	7.54	8.29	8.33	8.25
620	8.37	8.40	8.34	7.76	7.79	7.73	8.21	8.24	8.18	9.49	9.52	9.46	7.84	7.87	7.81	8.12	8.15	8.09	7.69	7.72	7.66	8.03	8.12	8.06	7.57	7.60	7.54	8.30	8.33	8.27
625	8.33	8.35	8.31	7.75	7.77	7.73	8.31	8.33	8.29	9.48	9.50	9.46	7.84	7.86	7.82	8.12	8.14	8.10	7.69	7.71	7.67	8.03	8.05	8.01	7.58	7.60	7.54	8.31	8.33	8.29
630	8.35	8.38	8.32	7.75	7.78	7.72	8.26	8.29	8.23	9.47	9.50	9.44	7.84	7.87	7.81	8.11	8.14	8.08	7.69	7.72	7.66	8.10	8.13	8.07	7.57	7.60	7.54	8.34	8.37	8.31
635	8.34	8.36	8.32	7.75	7.77	7.73	8.29	8.31	8.27	9.47	9.49	9.45	7.84	7.86	7.82	8.10	8.12	8.08	7.69	7.71	7.67	8.11	8.13	8.09	7.57	7.59	7.55	8.26	8.28	8.24
640	8.43	8.46	8.40	7.75	7.78	7.72	8.32	8.35	8.29	9.46	9.49	9.43	7.83	7.86	7.80	8.09	8.12	8.06	7.68	7.71	7.65	8.12	8.15	8.09	7.57	7.60	7.54	8.24	8.27	8.21
645	8.32	8.35	8.29	7.74	7.77	7.71	8.37	8.40	8.34	9.45	9.48	9.42	7.82	7.85	7.79	8.09	8.12	8.06	7.68	7.71	7.65	8.09	8.12	8.06	7.56	7.59	7.53	8.20	8.23	8.17
650	8.30	8.32	8.28	7.74	7.76	7.72	8.26	8.28	8.24	9.45	9.47	9.43	7.82	7.84	7.80	8.10	8.12	8.08	7.69	7.70	7.66	8.05	8.07	8.03	7.56	7.58	7.52	8.23	8.25	8.21
655	8.19	8.21	8.17	7.73	7.75	7.71	8.30	8.32	8.28	9.45	9.47	9.43	7.82	7.84	7.80	8.09	8.11	8.07	7.68	7.70	7.66	8.03	8.11	8.09	7.56	7.58	7.52	8.27	8.29	8.25
660	8.41	8.43	8.39	7.73	7.75	7.71	8.28	8.30	8.26	9.45	9.47	9.43	7.82	7.84	7.80	8.09	8.11	8.07	7.68	7.70	7.66	8.11	8.13	8.09	7.56	7.58	7.52	8.20	8.22	8.18
665	8.38	8.40	8.36	7.73	7.75	7.71	8.30	8.32	8.28	9.43	9.45	9.41	7.82	7.84	7.80	8.08	8.10	8.06	7.69	7.70	7.66	8.11	8.13	8.09	7.56	7.58	7.52	8.30	8.32	8.26
670	8.44	8.46	8.40	7.72	7.76	7.68	8.28	8.32	8.24	9.43	9.45	9.41	7.82	7.84	7.80	8.07	8.10	8.03	7.66	7.72	7.64	8.06	8.10	8.02	7.56	7.60	7.54	8.26	8.30	8.22
675	8.54	8.56	8.52	7.72	7.74	7.70	8.29	8.31	8.27	9.41	9.43	9.39	7.82	7.84	7.80	8.08	8.10	8.06	7.68	7.70	7.66	8.04	8.06	8.02	7.55	7.57	7.53	8.31	8.33	8.29
680	8.40	8.43	8.37	7.71	7.74	7.69	8.27	8.30	8.24	9.41	9.44	9.38	7.81	7.84	7.78	8.06	8.09	8.03	7.68	7.71	7.65	8.10	8.13	8.07	7.55	7.58	7.52	8.32	8.34	8.28
685	8.36	8.41	8.35	7.70	7.73	7.67	8.27	8.31	8.23	9.40	9.44	9.36	7.81	7.85	7.77	8.05	8.09	8.01	7.67	7.71	7.63	8.03	8.07	7.99	7.55	7.59	7.51	8.26	8.30	8.22
690	8.41	8.44	8.38	7.70	7.73	7.67	8.23	8.26	8.20	9.40	9.44	9.36	7.80	7.83	7.77	8.05	8.09	8.03	7.67	7.70	7.64	8.05	8.08	8.02	7.55	7.58	7.52	8.31	8.34	8.28
695	8.38	8.41	8.35	7.70	7.73	7.67	8.24	8.27	8.21	9.38	9.42	9.36	7.80	7.83	7.77	8.06	8.09	8.03	7.67	7.70	7.64	8.05	8.08	8.02	7.55	7.58	7.52	8.31	8.34	8.28
700	8.51	8.53	8.49	7.71	7.73	7.69	8.39	8.41	8.37	9.39	9.41	9.37	7.80	7.82	7.78	8.05	8.07	8.03	7.67	7.69	7.65	7.97	7.99	7.95	7.53	7.55	7.51	8.40	8.42	8.38
705	8.47	8.50	8.44	7.69	7.72	7.66	8.40	8.43	8.37	9.39	9.42	9.36	7.80	7.83	7.77	8.05	8.09	8.02	7.67	7.69	7.65	7.97	7.99	7.95	7.53	7.55	7.51	8.40	8.42	8.38
710	8.40	8.42	8.36	7.69	7.71	7.67	8.28	8.30	8.26	9.38	9.40	9.36	7.81	7.83	7.79	8.05	8.07	8.03	7.67	7.68	7.65	7.97	7.99	7.95	7.54	7.56	7.52	8.15	8.17	8.13
715	8.40	8.43	8.37	7.68	7.71	7.65	8.29	8.32	8.26	9.37	9.40	9.34	7.80	7.83	7.77	8.05	8.08	8.02	7.66	7.68	7.63	8.00	8.03	7.97	7.54	7.57	7.51	8.26	8.29	8.23
720	8.41	8.44	8.38	7.68	7.72	7.66	8.39	8.42	8.36	9.36	9.38	9.34	7.80	7.83	7.77	8.04	8.07	8.01	7.66	7.68	7.63	8.01	8.04	7.98	7.53	7.56	7.50	8.38	8.41	8.35
725	8.46	8.47	8.43	7.63	7.71	7.67	8.37	8.39	8.35	9.36	9.38	9.34	7.79	7.81	7.77	8.03	8.05	8.01	7.66	7.68	7.64	7.97	7.99	7.95	7.51	7.54	7.48	8.42	8.44	8.38
730	8.40	8.42	8.36	7.68	7.70	7.66	8.28	8.30	8.26	9.36	9.38	9.34	7.79	7.81	7.77	8.03	8.05	8.01	7.65	7.67	7.63	7.98	8.01	7.97	7.53	7.55	7.51	8.39	8.41	8.37
735	8.52	8.54	8.50	7.68	7.70	7.66	8.23	8.25	8.21	9.35	9.37	9.33	7.80	7.82	7.78	8.03	8.05	8.01	7.65	7.67	7.63	7.98	8.00	7.96	7.53	7.55	7.51	8.43	8.45	8.41
740	8.52	8.54	8.50	7.68	7.70	7.66	8.22	8.24	8.20	9.35	9.37	9.33	7.79	7.81	7.77	8.04	8.06	8.02	7.66	7.67	7.63	7.95	7.97	7.93	7.53	7.55	7.51	8.37	8.39	8.35
745	8.53	8.57	8.49	7.67	7.71	7.63	8.26	8.30	8.22	9.34	9.38	9.30	7.79	7.83	7.75	8.03	8.07	7.99	7.64	7.68	7.60	7.99	8.03	7.95	7.53	7.57	7.49	8.17	8.21	8.13
750	8.48	8.50	8.46	7.67	7.69	7.65	8.20	8.22	8.18	9.34	9.36	9.32	7.79	7.81	7.77	8.03	8.05	8.01	7.64	7.66	7.62	7.98	8.00	7.96	7.53	7.55	7.51	8.06	8.08	8.04
755	8.39	8.42	8.36	7.67	7.71	7.65	8.22	8.25	8.19	9.33	9.36	9.30	7.78	7.81	7.75	8.01	8.04	8.00	7.64	7.66	7.62	7.98	7.99	7.93	7.53	7.56	7.50	8.34	8.37	8.31
760	8.52	8.55	8.49	7.67	7.70	7.64	8.24	8.27	8.21	9.33	9.36	9.30	7.78	7.81	7.75	8.02	8.05	7.98	7.64	7.67	7.61	8.03	8.06	8.00	7.52	7.55	7.49	8.17	8.20	8.14
765	8.59	8.63	8.55	7.67	7.71	7.63	8.30	8.34	8.26	9.32	9.36	9.28	7.78	7.82	7.74	8.02	8.06	7.98	7.64	7.68	7.60	8.05	8.09	8.01	7.52	7.56	7.48	8.20	8.24	8.16
770	8.39	8.42	8.36	7.66	7.69	7.63	8.23	8.26	8.20	9.31	9.34</																			

Table 1.4

Average pH at different Arbitrary Concentrations and 0mg Orlistat (+/-0.02)										
Time (Sec)	100	90	80	70	60	50	40	30	20	10
0	9.95	10.11	10.03	10.05	10.01	10.09	9.69	9.64	9.89	10.00
5	9.92	10.08	10.00	10.03	9.91	10.06	9.64	9.75	9.88	9.97
10	9.91	10.07	10.00	9.98	9.92	10.06	9.62	9.59	9.85	9.94
15	9.91	10.06	9.98	9.99	9.85	10.05	9.59	9.58	9.84	9.92
20	9.90	10.03	9.97	9.97	9.90	10.02	9.58	9.56	9.82	9.89
25	9.90	10.03	9.96	9.95	9.89	10.01	9.56	9.53	9.81	9.85
30	9.89	10.01	9.95	9.92	9.86	9.98	9.56	9.53	9.80	9.83
35	9.89	10.01	9.93	9.94	9.86	9.96	9.52	9.50	9.78	9.80
40	9.88	10.00	9.90	9.92	9.85	9.94	9.51	9.46	9.76	9.78
45	9.88	9.98	9.89	9.91	9.81	9.93	9.48	9.44	9.75	9.74
50	9.88	9.96	9.88	9.90	9.80	9.91	9.46	9.43	9.74	9.72
55	9.87	9.92	9.89	9.89	9.78	9.89	9.45	9.41	9.71	9.66
60	9.86	9.94	9.88	9.87	9.76	10.03	9.43	9.34	9.70	9.62
65	9.86	9.90	9.87	9.86	9.70	9.88	9.40	9.34	9.69	9.56
70	9.85	9.89	9.83	9.84	9.68	9.86	9.39	9.34	9.67	9.49
75	9.84	9.88	9.82	9.83	9.67	9.84	9.37	9.29	9.67	9.42
80	9.84	9.87	9.80	9.82	9.64	9.83	9.34	9.26	9.63	9.34
85	9.83	9.86	9.77	9.80	9.63	9.80	9.32	9.22	9.63	9.23
90	9.82	9.85	9.79	9.79	9.61	9.77	9.28	9.19	9.62	9.15
95	9.82	9.83	9.76	9.78	9.59	9.73	9.27	9.15	9.60	9.05
100	9.81	9.80	9.75	9.78	9.58	9.73	9.25	9.11	9.58	8.98
105	9.81	9.78	9.74	9.77	9.59	9.70	9.21	9.09	9.56	8.83
110	9.80	9.76	9.75	9.74	9.54	9.68	9.18	9.04	9.53	8.81
115	9.79	9.78	9.72	9.73	9.53	9.65	9.15	9.00	9.51	8.74
120	9.78	9.79	9.72	9.71	9.50	9.63	9.10	8.95	9.49	8.67
125	9.77	9.69	9.70	9.68	9.49	9.61	9.07	8.92	9.46	8.62
130	9.77	9.68	9.70	9.68	9.44	9.58	9.04	8.89	9.44	8.56
135	9.76	9.65	9.69	9.66	9.43	9.57	9.00	8.82	9.41	8.52
140	9.75	9.69	9.67	9.65	9.43	9.52	8.98	8.79	9.43	8.49
145	9.74	9.69	9.67	9.62	9.41	9.52	8.92	8.73	9.39	8.45
150	9.73	9.67	9.66	9.61	9.39	9.49	8.88	8.71	9.36	8.41
155	9.72	9.61	9.63	9.59	9.34	9.45	8.82	8.64	9.33	8.38
160	9.71	9.58	9.62	9.58	9.33	9.39	8.78	8.60	9.31	8.35
165	9.71	9.56	9.60	9.56	9.31	9.33	8.73	8.55	9.27	8.32
170	9.70	9.55	9.57	9.54	9.27	9.27	8.68	8.43	9.24	8.29
175	9.69	9.53	9.55	9.52	9.24	9.24	8.63	8.39	9.22	8.29
180	9.68	9.54	9.55	9.50	9.21	9.20	8.59	8.42	9.19	8.27
185	9.67	9.54	9.52	9.47	9.17	9.08	8.53	8.32	9.14	8.24
190	9.67	9.52	9.52	9.45	9.14	9.03	8.49	8.35	9.12	8.23

Average pH at different Arbitrary Concentrations and 0mg Orlistat (+/-0.02)

Time (Sec)	100	90	80	70	60	50	40	30	20	10
195	9.66	9.51	9.50	9.43	9.10	8.96	8.45	8.36	9.08	8.21
200	9.65	9.48	9.46	9.40	9.05	8.92	8.41	8.25	9.04	8.19
205	9.64	9.47	9.46	9.38	9.04	8.84	8.39	8.29	9.01	8.15
210	9.64	9.46	9.43	9.34	8.93	8.79	8.33	8.25	8.99	8.13
215	9.63	9.39	9.40	9.31	8.88	8.75	8.28	8.25	8.94	8.14
220	9.63	9.38	9.38	9.27	8.83	8.69	8.23	8.19	8.93	8.12
225	9.62	9.36	9.38	9.23	8.82	8.60	8.21	8.13	8.62	8.11
230	9.62	9.34	9.33	9.19	8.75	8.54	8.17	8.06	8.54	8.11
235	9.61	9.26	9.30	9.15	8.68	8.50	8.14	8.11	8.53	8.07
240	9.60	9.24	9.26	9.12	8.65	8.51	8.12	8.03	8.48	8.08
245	9.60	9.22	9.24	9.08	8.56	8.46	8.09	8.04	8.42	8.09
250	9.59	9.15	9.18	9.03	8.55	8.42	8.06	8.07	8.38	8.06
255	9.59	9.11	9.14	8.98	8.50	8.34	8.03	8.05	8.35	8.05
260	9.58	9.11	9.12	8.95	8.44	8.32	8.01	8.02	8.31	8.03
265	9.57	9.05	9.09	8.91	8.39	8.28	7.96	7.99	8.27	8.03
270	9.56	8.98	9.04	8.87	8.37	8.24	7.97	7.98	8.22	8.01
275	9.56	8.95	9.02	8.82	8.32	8.20	7.95	7.98	8.20	8.02
280	9.55	8.88	8.96	8.80	8.28	8.16	7.94	7.98	8.13	8.03
285	9.55	8.84	8.92	8.77	8.24	8.17	7.92	7.98	8.12	8.02
290	9.54	8.80	8.88	8.73	8.25	8.14	7.88	7.95	8.10	8.01
295	9.53	8.76	8.84	8.70	8.22	8.17	7.88	7.95	8.09	8.01
300	9.52	8.69	8.80	8.68	8.17	8.15	7.86	7.93	8.05	7.97
305	9.51	8.65	8.76	8.66	8.15	8.12	7.85	7.93	8.00	7.97
310	9.51	8.59	8.71	8.62	8.11	8.09	7.83	7.93	7.98	7.96
315	9.50	8.51	8.68	8.57	8.08	8.08	7.82	7.91	7.95	7.92
320	9.50	8.50	8.63	8.53	8.05	8.07	7.80	7.92	7.94	7.91
325	9.49	8.46	8.59	8.50	8.04	8.03	7.81	7.90	7.93	7.87
330	9.48	8.42	8.56	8.47	8.01	8.04	7.80	7.89	7.90	7.92
335	9.47	8.39	8.53	8.45	8.01	8.03	7.78	7.87	7.89	7.92
340	9.46	8.34	8.50	8.43	8.00	7.97	7.76	7.85	7.89	7.90
345	9.45	8.26	8.46	8.39	7.97	7.98	7.74	7.78	7.87	7.90
350	9.44	8.27	8.47	8.37	7.96	7.99	7.73	7.83	7.85	7.90
355	9.44	8.23	8.41	8.34	7.96	7.97	7.71	7.84	7.83	7.89
360	9.43	8.22	8.37	8.32	7.91	7.96	7.71	7.83	7.84	7.86
365	9.41	8.16	8.32	8.29	7.91	7.93	7.70	7.82	7.80	7.87
370	9.41	8.13	8.30	8.27	7.89	7.92	7.70	7.80	7.79	7.91
375	9.39	8.12	8.26	8.26	7.88	7.87	7.67	7.79	7.77	7.90
380	9.39	8.10	8.23	8.22	7.86	7.80	7.66	7.79	7.76	7.90
385	9.38	8.05	8.22	8.20	7.93	7.74	7.65	7.71	7.76	7.86

Average pH at different Arbitrary Concentrations and 0mg Orlistat (+/-0.02)

Time (Sec)	100	90	80	70	60	50	40	30	20	10
390	9.36	8.07	8.20	8.18	7.84	7.84	7.65	7.76	7.75	7.88
395	9.35	8.05	8.18	8.15	7.88	7.79	7.64	7.78	7.73	7.88
400	9.34	8.04	8.14	8.13	7.79	7.80	7.62	7.76	7.71	7.87
405	9.33	7.96	8.12	8.10	7.79	7.78	7.62	7.76	7.71	7.87
410	9.32	7.96	8.12	8.07	7.78	7.76	7.62	7.77	7.70	7.90
415	9.30	7.96	8.10	8.06	7.76	7.73	7.61	7.80	7.69	7.86
420	9.29	7.97	8.09	8.04	7.75	7.75	7.60	7.77	7.68	7.86
425	9.28	7.93	8.07	8.03	7.74	7.74	7.59	7.81	7.71	7.86
430	9.27	7.90	8.05	8.01	7.73	7.69	7.58	7.81	7.66	7.85
435	9.25	7.87	8.04	8.00	7.71	7.71	7.58	7.75	7.64	7.85
440	9.23	7.80	8.03	7.99	7.70	7.70	7.56	7.73	7.60	7.85
445	9.22	7.89	8.02	7.98	7.70	7.68	7.56	7.77	7.65	7.86
450	9.20	7.83	8.00	7.96	7.68	7.69	7.56	7.73	7.64	7.86
455	9.18	7.86	7.98	7.93	7.67	7.68	7.55	7.73	7.64	7.85
460	9.16	7.85	8.02	7.91	7.70	7.68	7.55	7.72	7.63	7.84
465	9.14	7.82	7.97	7.91	7.69	7.68	7.55	7.77	7.62	7.84
470	9.12	7.84	7.95	7.90	7.68	7.67	7.53	7.74	7.55	7.83
475	9.09	7.82	7.96	7.88	7.67	7.66	7.52	7.73	7.59	7.81
480	9.06	7.81	7.95	7.85	7.65	7.64	7.52	7.74	7.59	7.83
485	9.04	7.82	7.93	7.84	7.63	7.63	7.51	7.72	7.59	7.80
490	9.00	7.72	7.92	7.83	7.66	7.64	7.49	7.71	7.58	7.83
495	8.97	7.70	7.92	7.83	7.62	7.64	7.50	7.72	7.58	7.82
500	8.94	7.70	7.91	7.80	7.61	7.62	7.49	7.74	7.58	7.80
505	8.90	7.73	7.91	7.79	7.60	7.62	7.49	7.71	7.57	7.84
510	8.86	7.69	7.89	7.77	7.60	7.60	7.48	7.67	7.59	7.83
515	8.82	7.75	7.89	7.77	7.59	7.60	7.47	7.69	7.56	7.84
520	8.78	7.67	7.89	7.76	7.58	7.58	7.48	7.68	7.56	7.82
525	8.74	7.66	7.87	7.75	7.60	7.57	7.48	7.67	7.55	7.83
530	8.70	7.65	7.87	7.75	7.58	7.59	7.49	7.68	7.55	7.81
535	8.66	7.72	7.86	7.74	7.57	7.53	7.48	7.67	7.55	7.81
540	8.62	7.65	7.85	7.74	7.65	7.57	7.46	7.66	7.55	7.82
545	8.58	7.71	7.85	7.72	7.64	7.54	7.45	7.67	7.57	7.81
550	8.54	7.72	7.84	7.72	7.55	7.50	7.45	7.68	7.56	7.81
555	8.49	7.71	7.83	7.71	7.55	7.54	7.44	7.66	7.55	7.81
560	8.45	7.70	7.84	7.71	7.56	7.57	7.45	7.63	7.54	7.80
565	8.41	7.71	7.83	7.65	7.55	7.55	7.44	7.66	7.52	7.81
570	8.37	7.69	7.83	7.68	7.55	7.54	7.43	7.67	7.53	7.80
575	8.33	7.68	7.83	7.70	7.54	7.56	7.42	7.67	7.52	7.80
580	8.29	7.65	7.81	7.67	7.56	7.56	7.34	7.66	7.51	7.80

Average pH at different Arbitrary Concentrations and 0mg Orlistat (+/-0.02)

Time (Sec)	100	90	80	70	60	50	40	30	20	10
585	8.25	7.66	7.85	7.66	7.53	7.55	7.34	7.67	7.51	7.78
590	8.20	7.69	7.79	7.64	7.53	7.55	7.38	7.66	7.50	7.80
595	8.16	7.66	7.79	7.66	7.53	7.51	7.37	7.64	7.49	7.78
600	8.12	7.63	7.78	7.65	7.51	7.48	7.42	7.68	7.49	7.77
605	8.09	7.65	7.77	7.60	7.51	7.50	7.45	7.64	7.48	7.77
610	8.05	7.64	7.77	7.61	7.50	7.58	7.42	7.65	7.48	7.72
615	8.01	7.62	7.77	7.64	7.50	7.54	7.42	7.66	7.47	7.74
620	7.98	7.61	7.77	7.64	7.49	7.54	7.41	7.65	7.47	7.68
625	7.95	7.65	7.78	7.64	7.49	7.57	7.41	7.64	7.47	7.68
630	7.91	7.58	7.78	7.61	7.51	7.50	7.42	7.62	7.45	7.74
635	7.88	7.61	7.76	7.62	7.50	7.52	7.41	7.63	7.45	7.67
640	7.85	7.62	7.75	7.61	7.49	7.52	7.39	7.62	7.48	7.75
645	7.82	7.57	7.75	7.62	7.49	7.49	7.38	7.63	7.47	7.75
650	7.79	7.57	7.74	7.64	7.48	7.54	7.39	7.61	7.46	7.72
655	7.76	7.57	7.74	7.62	7.50	7.56	7.39	7.61	7.46	7.77
660	7.74	7.60	7.74	7.62	7.49	7.54	7.39	7.62	7.46	7.76
665	7.71	7.58	7.76	7.59	7.48	7.54	7.30	7.61	7.45	7.76
670	7.69	7.57	7.73	7.60	7.50	7.54	7.38	7.60	7.45	7.75
675	7.66	7.57	7.72	7.60	7.47	7.54	7.37	7.59	7.44	7.76
680	7.64	7.56	7.74	7.60	7.47	7.52	7.29	7.60	7.44	7.76
685	7.62	7.54	7.74	7.59	7.47	7.53	7.32	7.59	7.45	7.76
690	7.59	7.55	7.72	7.59	7.47	7.51	7.40	7.59	7.43	7.73
695	7.57	7.55	7.72	7.60	7.45	7.53	7.40	7.59	7.40	7.74
700	7.56	7.52	7.71	7.59	7.45	7.50	7.35	7.66	7.40	7.70
705	7.53	7.48	7.71	7.59	7.44	7.50	7.35	7.59	7.43	7.75
710	7.52	7.58	7.71	7.57	7.45	7.51	7.33	7.60	7.42	7.75
715	7.50	7.60	7.71	7.55	7.44	7.46	7.34	7.59	7.42	7.74
720	7.48	7.58	7.69	7.56	7.44	7.51	7.33	7.59	7.42	7.73
725	7.46	7.56	7.70	7.57	7.45	7.52	7.25	7.60	7.43	7.75
730	7.45	7.53	7.70	7.56	7.44	7.50	7.28	7.60	7.42	7.75
735	7.43	7.56	7.68	7.52	7.43	7.51	7.24	7.59	7.37	7.76
740	7.42	7.55	7.67	7.54	7.42	7.51	7.25	7.59	7.42	7.77
745	7.40	7.54	7.68	7.52	7.42	7.45	7.27	7.61	7.42	7.73
750	7.39	7.52	7.69	7.51	7.41	7.49	7.32	7.61	7.42	7.75
755	7.38	7.53	7.69	7.51	7.40	7.49	7.33	7.61	7.42	7.73
760	7.36	7.51	7.68	7.51	7.41	7.50	7.31	7.61	7.38	7.76
765	7.35	7.53	7.68	7.50	7.41	7.49	7.31	7.60	7.41	7.77
770	7.34	7.54	7.68	7.52	7.40	7.47	7.21	7.57	7.38	7.76
775	7.32	7.53	7.69	7.50	7.40	7.47	7.28	7.57	7.40	7.76

Average pH at different Arbitrary Concentrations and 0mg Orlistat (+/-0.02)

Time (Sec)	100	90	80	70	60	50	40	30	20	10
780	7.31	7.51	7.69	7.50	7.39	7.49	7.29	7.56	7.42	7.76
785	7.30	7.51	7.67	7.51	7.40	7.48	7.29	7.55	7.40	7.75
790	7.29	7.51	7.67	7.51	7.40	7.46	7.29	7.56	7.39	7.75
795	7.28	7.53	7.67	7.49	7.39	7.40	7.27	7.58	7.39	7.73
800	7.27	7.52	7.67	7.49	7.40	7.46	7.28	7.55	7.35	7.73
805	7.26	7.51	7.66	7.48	7.38	7.47	7.32	7.55	7.36	7.74
810	7.25	7.52	7.66	7.48	7.39	7.33	7.29	7.56	7.35	7.71
815	7.24	7.51	7.67	7.49	7.39	7.37	7.28	7.67	7.40	7.72
820	7.23	7.51	7.67	7.48	7.38	7.44	7.29	7.65	7.36	7.72
825	7.22	7.49	7.65	7.49	7.39	7.44	7.20	7.57	7.35	7.72
830	7.21	7.49	7.65	7.47	7.39	7.45	7.27	7.57	7.37	7.72
835	7.20	7.50	7.64	7.48	7.37	7.45	7.28	7.59	7.40	7.71
840	7.19	7.51	7.63	7.47	7.37	7.46	7.28	7.52	7.39	7.71
845	7.18	7.50	7.61	7.48	7.38	7.45	7.28	7.52	7.38	7.72
850	7.18	7.48	7.61	7.46	7.41	7.43	7.27	7.51	7.39	7.74
855	7.17	7.49	7.64	7.46	7.37	7.41	7.28	7.53	7.40	7.74
860	7.16	7.49	7.63	7.45	7.37	7.43	7.30	7.58	7.36	7.74
865	7.15	7.52	7.63	7.45	7.37	7.46	7.28	7.56	7.36	7.73
870	7.15	7.50	7.63	7.45	7.37	7.47	7.27	7.56	7.33	7.72
875	7.14	7.50	7.63	7.44	7.37	7.44	7.27	7.53	7.33	7.72
880	7.13	7.52	7.61	7.45	7.38	7.45	7.27	7.54	7.33	7.72
885	7.13	7.49	7.61	7.45	7.37	7.42	7.28	7.53	7.33	7.72
890	7.12	7.49	7.62	7.46	7.37	7.44	7.30	7.52	7.35	7.71
895	7.11	7.50	7.57	7.45	7.37	7.46	7.18	7.50	7.32	7.73
900	7.11	7.49	7.60	7.44	7.40	7.46	7.27	7.52	7.33	7.72

Table 1.5

Average pH at different Arbitrary Concentrations and 60mg Orlistat (+/- 0.02)										
Time (Sec)	100	90	80	70	60	50	40	30	20	10
0	9.56	10.07	9.63	9.91	9.61	9.63	9.38	10.42	9.14	9.63
5	9.56	10.06	9.61	9.90	9.52	9.61	9.36	10.37	9.15	9.64
10	9.54	10.04	9.59	9.90	9.48	9.59	9.34	10.34	9.10	9.64
15	9.54	10.03	9.57	9.88	9.45	9.58	9.33	10.29	9.04	9.72
20	9.53	10.01	9.56	9.87	9.43	9.55	9.32	10.25	9.01	9.66
25	9.53	10.00	9.55	9.85	9.44	9.54	9.31	10.23	8.97	9.61
30	9.52	9.99	9.54	9.84	9.37	9.52	9.29	10.20	8.95	9.58
35	9.51	9.99	9.53	9.84	9.37	9.49	9.29	10.18	8.92	9.55
40	9.48	9.98	9.52	9.82	9.46	9.47	9.28	10.15	8.89	9.51
45	9.46	9.96	9.51	9.81	9.46	9.46	9.27	10.13	8.87	9.49
50	9.46	9.95	9.50	9.80	9.29	9.43	9.26	10.11	8.85	9.46
55	9.43	9.94	9.49	9.79	9.28	9.41	9.25	10.09	8.83	9.44
60	9.43	9.92	9.47	9.78	9.26	9.39	9.24	10.06	8.80	9.43
65	9.42	9.92	9.46	9.76	9.22	9.37	9.23	10.03	8.78	9.41
70	9.38	9.90	9.44	9.75	9.21	9.34	9.22	10.01	8.76	9.39
75	9.38	9.89	9.42	9.74	9.33	9.32	9.20	9.99	8.75	9.37
80	9.36	9.87	9.40	9.72	9.20	9.30	9.20	9.96	8.72	9.36
85	9.33	9.86	9.39	9.71	9.09	9.28	9.18	9.93	8.70	9.34
90	9.30	9.85	9.37	9.69	9.11	9.25	9.17	9.91	8.69	9.33
95	9.29	9.84	9.34	9.67	9.07	9.23	9.16	9.89	8.66	9.31
100	9.26	9.84	9.32	9.66	9.16	9.21	9.14	9.87	8.65	9.30
105	9.26	9.82	9.30	9.64	9.17	9.18	9.12	9.84	8.63	9.29
110	9.24	9.81	9.28	9.62	9.00	9.16	9.11	9.82	8.60	9.28
115	9.21	9.80	9.26	9.61	8.96	9.13	9.09	9.79	8.59	9.27
120	9.19	9.78	9.24	9.59	8.94	9.11	9.08	9.75	8.57	9.27
125	9.18	9.77	9.22	9.57	8.98	9.08	9.06	9.73	8.55	9.25
130	9.16	9.76	9.19	9.55	9.01	9.06	9.04	9.69	8.53	9.24
135	9.14	9.74	9.17	9.53	8.88	9.04	9.03	9.65	8.50	9.23
140	9.11	9.73	9.15	9.51	8.83	9.02	9.01	9.61	8.49	9.22
145	9.08	9.71	9.13	9.49	8.82	8.99	8.99	9.58	8.46	9.21
150	9.08	9.69	9.10	9.46	8.79	8.97	8.97	9.54	8.43	9.20
155	9.06	9.68	9.09	9.45	8.80	8.94	8.95	9.51	8.41	9.20
160	9.04	9.67	9.06	9.43	8.85	8.92	8.93	9.46	8.39	9.21
165	9.02	9.65	9.04	9.41	8.81	8.90	8.91	9.44	8.36	9.21
170	8.99	9.63	9.02	9.39	8.81	8.88	8.88	9.40	8.34	9.21
175	8.99	9.61	9.00	9.38	8.84	8.86	8.86	9.36	8.32	9.20
180	8.96	9.60	8.98	9.36	8.70	8.83	8.83	9.34	8.29	9.18
185	8.94	9.58	8.96	9.34	8.82	8.81	8.80	9.30	8.27	9.19

Average pH at different Arbitrary Concentrations and 60mg Orlistat (+/- 0.02)

Time (Sec)	100	90	80	70	60	50	40	30	20	10
190	8.90	9.57	8.94	9.32	8.73	8.79	8.77	9.28	8.25	9.18
195	8.89	9.55	8.93	9.30	8.81	8.77	8.74	9.25	8.22	9.17
200	8.89	9.54	8.91	9.28	8.77	8.74	8.70	9.23	8.20	9.17
205	8.87	9.52	8.89	9.26	8.83	8.71	8.66	9.20	8.18	9.17
210	8.85	9.51	8.87	9.23	8.79	8.68	8.63	9.18	8.16	9.17
215	8.84	9.49	8.86	9.20	8.80	8.66	8.59	9.15	8.14	9.15
220	8.80	9.47	8.83	9.17	8.59	8.64	8.55	9.13	8.12	9.15
225	8.80	9.46	8.81	9.14	8.75	8.61	8.51	9.11	8.11	9.14
230	8.78	9.45	8.80	9.10	8.61	8.58	8.48	9.09	8.08	9.13
235	8.75	9.43	8.78	9.07	8.57	8.56	8.43	9.07	8.07	9.12
240	8.74	9.41	8.76	9.03	8.68	8.53	8.39	9.05	8.05	9.12
245	8.73	9.40	8.73	8.99	8.68	8.51	8.35	9.03	8.04	9.11
250	8.72	9.39	8.71	8.94	8.53	8.49	8.32	9.02	8.02	9.11
255	8.70	9.37	8.69	8.89	8.50	8.47	8.29	9.00	8.01	9.10
260	8.69	9.36	8.67	8.85	8.52	8.45	8.26	8.99	7.99	9.09
265	8.67	9.33	8.64	8.80	8.48	8.43	8.22	8.97	7.97	9.09
270	8.64	9.32	8.62	8.77	8.33	8.42	8.20	8.96	7.97	9.08
275	8.64	9.31	8.59	8.72	8.44	8.40	8.17	8.94	7.95	9.07
280	8.61	9.30	8.56	8.69	8.49	8.40	8.14	8.92	7.94	9.07
285	8.59	9.28	8.53	8.65	8.46	8.38	8.12	8.89	7.93	9.06
290	8.58	9.27	8.50	8.61	8.43	8.38	8.09	8.90	7.92	9.06
295	8.55	9.25	8.48	8.58	8.43	8.36	8.07	8.87	7.91	9.06
300	8.55	9.24	8.45	8.56	8.42	8.35	8.05	8.87	7.89	9.05
305	8.52	9.22	8.42	8.53	8.40	8.34	8.04	8.85	7.88	9.04
310	8.49	9.21	8.39	8.50	8.27	8.34	8.01	8.84	7.88	9.04
315	8.47	9.19	8.37	8.48	8.26	8.33	8.00	8.83	7.87	9.03
320	8.44	9.18	8.34	8.46	8.24	8.33	7.98	8.81	7.85	9.03
325	8.41	9.17	8.32	8.44	8.23	8.32	7.97	8.80	7.84	9.02
330	8.39	9.15	8.30	8.42	8.23	8.31	7.95	8.79	7.83	9.02
335	8.38	9.13	8.28	8.40	8.23	8.30	7.93	8.79	7.83	9.01
340	8.33	9.12	8.26	8.38	8.00	8.29	7.92	8.78	7.82	9.00
345	8.30	9.10	8.25	8.36	8.27	8.28	7.90	8.77	7.82	9.00
350	8.29	9.09	8.23	8.34	8.25	8.28	7.89	8.75	7.80	9.00
355	8.25	9.07	8.21	8.33	8.30	8.27	7.88	8.74	7.79	8.99
360	8.22	9.06	8.20	8.31	8.27	8.26	7.87	8.72	7.79	8.99
365	8.19	9.04	8.19	8.30	8.18	8.26	7.86	8.72	7.78	8.98
370	8.15	9.03	8.18	8.28	8.34	8.24	7.84	8.72	7.77	8.97
375	8.14	9.01	8.17	8.27	8.30	8.24	7.83	8.71	7.76	8.96

Average pH at different Arbitrary Concentrations and 60mg Orlistat (+/- 0.02)

Time (Sec)	100	90	80	70	60	50	40	30	20	10
380	8.13	9.00	8.16	8.27	8.32	8.23	7.82	8.70	7.76	8.96
385	8.09	8.98	8.15	8.25	8.28	8.22	7.82	8.69	7.75	8.95
390	8.07	8.96	8.14	8.24	8.22	8.21	7.80	8.68	7.75	8.95
395	8.05	8.95	8.13	8.23	8.19	8.21	7.79	8.67	7.74	8.94
400	8.04	8.93	8.12	8.22	8.30	8.20	7.79	8.67	7.73	8.94
405	8.02	8.92	8.12	8.21	8.33	8.19	7.78	8.66	7.73	8.93
410	8.00	8.91	8.11	8.20	8.29	8.19	7.77	8.65	7.72	8.92
415	7.98	8.90	8.11	8.19	8.29	8.18	7.76	8.64	7.71	8.93
420	7.96	8.88	8.10	8.19	8.28	8.18	7.75	8.64	7.71	8.92
425	7.98	8.87	8.10	8.18	8.26	8.17	7.74	8.63	7.70	8.92
430	7.95	8.85	8.09	8.17	8.27	8.16	7.73	8.62	7.69	8.92
435	7.94	8.84	8.09	8.16	8.29	8.15	7.73	8.62	7.69	8.91
440	7.92	8.83	8.08	8.16	8.27	8.15	7.73	8.61	7.69	8.90
445	7.91	8.82	8.08	8.15	8.27	8.14	7.72	8.62	7.68	8.90
450	7.91	8.81	8.07	8.14	8.26	8.14	7.72	8.61	7.68	8.89
455	7.90	8.79	8.07	8.13	8.24	8.13	7.70	8.60	7.67	8.89
460	7.87	8.78	8.07	8.13	8.26	8.12	7.70	8.60	7.67	8.88
465	7.88	8.77	8.06	8.12	8.26	8.12	7.70	8.60	7.67	8.87
470	7.87	8.77	8.06	8.12	8.21	8.12	7.70	8.59	7.66	8.88
475	7.87	8.75	8.06	8.11	8.20	8.11	7.68	8.59	7.66	8.87
480	7.86	8.74	8.05	8.11	8.29	8.10	7.68	8.58	7.65	8.87
485	7.85	8.73	8.05	8.10	8.20	8.10	7.68	8.58	7.65	8.86
490	7.83	8.72	8.05	8.10	8.00	8.10	7.67	8.57	7.65	8.86
495	7.82	8.71	8.05	8.09	8.22	8.09	7.67	8.57	7.65	8.85
500	7.83	8.71	8.04	8.09	8.23	8.09	7.67	8.55	7.64	8.84
505	7.81	8.69	8.04	8.08	8.21	8.08	7.66	8.56	7.64	8.84
510	7.81	8.69	8.03	8.07	8.26	8.07	7.66	8.56	7.63	8.85
515	7.82	8.68	8.03	8.08	8.23	8.07	7.66	8.55	7.63	8.84
520	7.80	8.67	8.02	8.06	8.21	8.07	7.65	8.55	7.63	8.83
525	7.81	8.66	8.02	8.06	8.17	8.06	7.65	8.55	7.62	8.84
530	7.80	8.65	8.01	8.06	8.27	8.06	7.64	8.53	7.62	8.83
535	7.79	8.64	8.01	8.05	8.18	8.06	7.65	8.53	7.62	8.83
540	7.78	8.64	8.00	8.05	8.17	8.05	7.64	8.53	7.61	8.82
545	7.78	8.63	8.00	8.05	8.26	8.05	7.64	8.52	7.61	8.82
550	7.77	8.63	8.00	8.04	8.24	8.05	7.64	8.52	7.61	8.82
555	7.77	8.62	8.00	8.04	8.23	8.05	7.63	8.52	7.60	8.81
560	7.78	8.61	7.99	8.03	8.12	8.05	7.63	8.51	7.60	8.81
565	7.77	8.60	7.99	8.03	8.12	8.05	7.62	8.52	7.60	8.81

Average pH at different Arbitrary Concentrations and 60mg Orlistat (+/- 0.02)

Time (Sec)	100	90	80	70	60	50	40	30	20	10
570	7.75	8.59	7.98	8.03	8.05	8.04	7.63	8.50	7.60	8.81
575	7.76	8.59	7.98	8.02	7.93	8.04	7.62	8.50	7.60	8.79
580	7.75	8.58	7.98	8.02	8.19	8.04	7.61	8.50	7.59	8.80
585	7.75	8.57	7.97	8.01	8.11	8.03	7.62	8.50	7.59	8.80
590	7.74	8.57	7.97	8.01	8.11	8.03	7.61	8.50	7.59	8.79
595	7.72	8.57	7.97	8.01	8.12	8.03	7.60	8.49	7.59	8.79
600	7.74	8.56	7.97	8.00	8.13	8.03	7.61	8.49	7.58	8.79
605	7.74	8.55	7.96	7.99	8.13	8.02	7.61	8.49	7.58	8.79
610	7.73	8.54	7.96	7.99	7.99	8.02	7.60	8.49	7.58	8.79
615	7.73	8.54	7.95	7.99	8.13	8.02	7.60	8.48	7.58	8.78
620	7.72	8.53	7.95	7.98	8.11	8.02	7.60	8.48	7.57	8.78
625	7.72	8.53	7.95	7.97	7.92	8.01	7.60	8.48	7.57	8.78
630	7.72	8.52	7.94	7.97	8.12	8.01	7.59	8.47	7.57	8.77
635	7.71	8.52	7.94	7.97	8.15	8.00	7.59	8.47	7.56	8.78
640	7.69	8.51	7.94	7.97	8.15	8.00	7.58	8.47	7.56	8.77
645	7.70	8.51	7.93	7.96	8.10	8.00	7.59	8.47	7.56	8.77
650	7.71	8.49	7.93	7.96	8.10	7.99	7.58	8.46	7.56	8.77
655	7.69	8.49	7.93	7.95	8.33	7.99	7.58	8.45	7.55	8.76
660	7.69	8.49	7.92	7.95	8.30	7.99	7.58	8.46	7.55	8.75
665	7.69	8.49	7.92	7.95	8.35	7.99	7.57	8.45	7.55	8.75
670	7.68	8.48	7.91	7.94	8.36	7.98	7.57	8.45	7.55	8.75
675	7.69	8.47	7.91	7.93	8.39	7.98	7.57	8.45	7.55	8.73
680	7.68	8.47	7.91	7.92	8.37	7.97	7.57	8.42	7.54	8.75
685	7.67	8.46	7.90	7.92	8.37	7.97	7.56	8.44	7.54	8.74
690	7.66	8.46	7.90	7.92	8.35	7.97	7.56	8.44	7.54	8.74
695	7.67	8.45	7.90	7.92	8.36	7.97	7.56	8.43	7.54	8.74
700	7.67	8.45	7.90	7.91	8.37	7.97	7.56	8.44	7.54	8.74
705	7.67	8.45	7.89	7.91	8.34	7.97	7.56	8.43	7.53	8.73
710	7.66	8.44	7.89	7.90	8.24	7.97	7.55	8.42	7.53	8.73
715	7.66	8.44	7.89	7.90	8.27	7.96	7.55	8.42	7.53	8.73
720	7.64	8.43	7.88	7.90	8.27	7.96	7.55	8.42	7.53	8.73
725	7.66	8.43	7.88	7.89	8.19	7.96	7.54	8.42	7.52	8.73
730	7.64	8.42	7.88	7.89	8.21	7.96	7.54	8.42	7.52	8.73
735	7.64	8.42	7.87	7.88	8.16	7.95	7.54	8.42	7.52	8.72
740	7.64	8.42	7.87	7.88	8.22	7.96	7.54	8.42	7.52	8.73
745	7.63	8.42	7.87	7.88	8.17	7.95	7.54	8.42	7.52	8.72
750	7.64	8.41	7.86	7.87	8.25	7.95	7.54	8.41	7.52	8.72
755	7.64	8.41	7.86	7.87	8.18	7.94	7.53	8.40	7.52	8.72

Average pH at different Arbitrary Concentrations and 60mg Orlistat (+/- 0.02)

Time (Sec)	100	90	80	70	60	50	40	30	20	10
760	7.63	8.40	7.86	7.87	8.23	7.94	7.53	8.41	7.51	8.72
765	7.63	8.40	7.86	7.87	8.25	7.94	7.53	8.40	7.51	8.72
770	7.63	8.40	7.85	7.87	8.21	7.94	7.52	8.40	7.51	8.72
775	7.62	8.40	7.85	7.86	8.09	7.94	7.52	8.40	7.51	8.72
780	7.63	8.39	7.85	7.86	7.99	7.93	7.52	8.40	7.50	8.72
785	7.63	8.38	7.85	7.85	8.17	7.93	7.52	8.40	7.51	8.72
790	7.61	8.38	7.84	7.86	7.96	7.93	7.52	8.40	7.51	8.71
795	7.61	8.38	7.84	7.85	8.15	7.93	7.52	8.39	7.50	8.71
800	7.62	8.37	7.84	7.85	8.00	7.92	7.52	8.39	7.50	8.71
805	7.61	8.37	7.83	7.84	8.14	7.92	7.52	8.39	7.50	8.70
810	7.61	8.37	7.83	7.85	8.09	7.92	7.52	8.39	7.49	8.71
815	7.61	8.36	7.83	7.84	8.27	7.92	7.51	8.38	7.49	8.71
820	7.58	8.36	7.82	7.84	8.09	7.92	7.51	8.39	7.49	8.69
825	7.61	8.36	7.82	7.83	8.05	7.91	7.51	8.38	7.49	8.70
830	7.61	8.36	7.82	7.84	8.23	7.91	7.51	8.38	7.49	8.68
835	7.59	8.36	7.82	7.83	8.16	7.91	7.50	8.37	7.48	8.69
840	7.59	8.35	7.81	7.82	8.12	7.91	7.51	8.37	7.49	8.69
845	7.59	8.35	7.81	7.82	8.16	7.91	7.50	8.37	7.48	8.68
850	7.59	8.34	7.81	7.82	8.20	7.91	7.50	8.37	7.48	8.68
855	7.58	8.35	7.80	7.82	8.16	7.90	7.49	8.36	7.48	8.68
860	7.59	8.34	7.80	7.82	8.08	7.90	7.50	8.37	7.47	8.68
865	7.57	8.34	7.80	7.82	8.00	7.90	7.49	8.37	7.47	8.68
870	7.57	8.34	7.80	7.82	8.14	7.90	7.49	8.36	7.47	8.67
875	7.59	8.33	7.80	7.82	8.08	7.90	7.49	8.36	7.47	8.67
880	7.58	8.33	7.80	7.82	8.08	7.90	7.49	8.36	7.47	8.67
885	7.57	8.33	7.79	7.82	8.05	7.90	7.49	8.36	7.47	8.67
890	7.57	8.32	7.79	7.82	8.06	7.89	7.48	8.35	7.47	8.67
895	7.56	8.32	7.79	7.81	8.07	7.89	7.48	8.35	7.46	8.66
900	7.57	8.32	7.79	7.81	8.02	7.89	7.49	8.35	7.46	8.66

The first part of the document discusses the importance of maintaining accurate records of all transactions. It emphasizes that every entry should be supported by a valid receipt or invoice. This ensures transparency and allows for easy verification of the data.

In the second section, the author outlines the various methods used to collect and analyze the data. This includes both primary and secondary data collection techniques. The analysis focuses on identifying trends and patterns over time, which is crucial for making informed decisions.

The third section provides a detailed breakdown of the results. It shows that there has been a significant increase in sales volume, particularly in the online channel. However, the profit margins have remained relatively stable, indicating that the company is effectively managing its costs.

Finally, the document concludes with several key recommendations. It suggests that the company should continue to invest in digital marketing and customer service to further drive growth. Additionally, it recommends regular audits to ensure the accuracy of the financial records.

Table 1.6

Average pH at different Arbitrary Concentrations and 120mg Orlistat (+/- 0.02)										
Time (Sec)	100	90	80	70	60	50	40	30	20	10
0	9.89	9.22	9.98	10.09	9.16	9.41	9.49	9.56	9.51	9.80
5	9.84	9.19	9.96	10.06	9.14	9.35	9.50	9.53	9.06	9.76
10	9.83	9.17	9.91	10.04	9.12	9.31	9.48	9.47	8.93	9.48
15	9.83	9.15	9.89	10.03	9.10	9.28	9.48	9.43	8.86	9.34
20	9.82	9.14	9.89	10.01	9.09	9.23	9.46	9.43	8.82	9.26
25	9.80	9.13	9.88	10.00	9.08	9.20	9.46	9.44	8.78	9.21
30	9.79	9.12	9.87	9.99	9.06	9.18	9.45	9.38	8.75	9.17
35	9.76	9.12	9.85	9.97	9.05	9.18	9.43	9.42	8.71	9.12
40	9.76	9.10	9.84	9.96	9.04	9.16	9.42	9.40	8.69	9.12
45	9.75	9.09	9.86	9.92	9.03	9.16	9.40	9.39	8.65	9.11
50	9.75	9.09	9.82	9.91	9.02	9.15	9.39	9.32	8.62	8.95
55	9.71	9.08	9.77	9.91	9.00	9.15	9.37	9.35	8.60	9.10
60	9.69	9.07	9.76	9.90	8.99	9.15	9.35	9.29	8.56	9.09
65	9.70	9.06	9.76	9.89	8.97	9.14	9.33	9.24	8.53	9.01
70	9.68	9.05	9.73	9.88	8.96	9.13	9.31	9.23	8.50	8.82
75	9.63	9.03	9.71	9.88	8.95	9.14	9.28	9.22	8.47	8.82
80	9.61	9.02	9.69	9.87	8.93	9.13	9.24	9.16	8.45	8.80
85	9.60	9.01	9.67	9.86	8.92	9.12	9.22	9.14	8.42	8.74
90	9.59	9.00	9.71	9.85	8.90	9.12	9.19	9.08	8.38	8.72
95	9.57	8.99	9.64	9.84	8.89	9.11	9.16	9.05	8.36	8.70
100	9.57	8.98	9.62	9.83	8.87	9.10	9.13	8.92	8.33	8.71
105	9.54	8.96	9.59	9.82	8.87	9.09	9.09	8.94	8.30	8.71
110	9.54	8.95	9.56	9.81	8.84	9.08	9.06	8.88	8.27	8.67
115	9.53	8.94	9.57	9.80	8.83	9.07	9.02	8.96	8.25	8.68
120	9.52	8.93	9.55	9.78	8.82	9.07	8.99	8.94	8.22	8.57
125	9.47	8.91	9.51	9.77	8.80	9.05	8.96	8.81	8.19	8.67
130	9.45	8.90	9.52	9.76	8.80	9.04	8.92	8.73	8.16	8.61
135	9.44	8.88	9.46	9.74	8.79	9.03	8.89	8.72	8.13	8.56
140	9.41	8.88	9.44	9.73	8.78	9.02	8.85	8.64	8.11	8.49
145	9.41	8.87	9.43	9.72	8.76	9.02	8.80	8.65	8.08	8.48
150	9.36	8.85	9.40	9.70	8.75	9.01	8.76	8.57	8.05	8.53
155	9.48	8.83	9.39	9.69	8.73	9.00	8.71	8.59	8.03	8.49
160	9.51	8.82	9.36	9.68	8.72	8.98	8.66	8.58	8.01	8.47
165	9.46	8.80	9.41	9.66	8.70	8.97	8.61	8.54	7.99	8.56
170	9.45	8.79	9.42	9.65	8.69	8.97	8.56	8.47	7.97	8.56
175	9.42	8.78	9.44	9.64	8.68	8.94	8.50	8.45	7.94	8.67
180	9.41	8.76	9.42	9.62	8.67	8.94	8.44	8.45	7.93	8.66
185	9.40	8.75	9.40	9.61	8.66	8.93	8.39	8.45	7.91	8.55

Average pH at different Arbitrary Concentrations and 120mg Orlistat (+/- 0.02)

Time (Sec)	100	90	80	70	60	50	40	30	20	10
190	9.37	8.74	9.41	9.59	8.64	8.92	8.33	8.40	7.90	8.64
195	9.37	8.72	9.40	9.58	8.63	8.91	8.28	8.37	7.88	8.60
200	9.38	8.71	9.34	9.57	8.62	8.90	8.23	8.40	7.87	8.57
205	9.35	8.70	9.36	9.56	8.61	8.88	8.19	8.34	7.85	8.56
210	9.28	8.68	9.37	9.54	8.60	8.86	8.14	8.36	7.84	8.48
215	9.30	8.66	9.33	9.53	8.58	8.86	8.11	8.34	7.83	8.49
220	9.31	8.66	9.34	9.51	8.57	8.85	8.06	8.34	7.82	8.45
225	9.28	8.64	9.30	9.51	8.56	8.83	8.05	8.30	7.82	8.44
230	9.28	8.62	9.26	9.49	8.55	8.81	8.02	8.33	7.81	8.58
235	9.25	8.61	9.26	9.48	8.53	8.80	7.99	8.28	7.80	8.54
240	9.25	8.60	9.24	9.46	8.53	8.80	7.97	8.28	7.79	8.54
245	9.22	8.59	9.22	9.45	8.52	8.77	7.95	8.23	7.78	8.58
250	9.18	8.57	9.23	9.43	8.50	8.77	7.93	8.19	7.78	8.55
255	9.22	8.56	9.22	9.42	8.49	8.76	7.91	8.20	7.77	8.54
260	9.12	8.55	9.17	9.40	8.48	8.74	7.90	8.20	7.76	8.60
265	9.11	8.53	9.12	9.39	8.47	8.73	7.89	8.21	7.76	8.61
270	9.12	8.52	9.25	9.36	8.46	8.72	7.87	8.21	7.76	8.62
275	9.08	8.51	9.09	9.35	8.45	8.70	7.87	8.16	7.76	8.52
280	9.08	8.49	9.22	9.33	8.44	8.69	7.85	8.21	7.75	8.54
285	9.05	8.48	9.19	9.32	8.43	8.68	7.85	8.19	7.75	8.54
290	9.09	8.46	9.18	9.29	8.42	8.66	7.83	8.14	7.75	8.54
295	9.06	8.45	8.99	9.28	8.41	8.65	7.82	8.13	7.75	8.51
300	9.09	8.43	9.06	9.25	8.40	8.64	7.82	8.17	7.74	8.51
305	9.08	8.42	9.03	9.23	8.39	8.61	7.82	8.18	7.73	8.52
310	9.06	8.40	9.04	9.21	8.38	8.61	7.81	8.17	7.73	8.51
315	9.02	8.39	9.03	9.19	8.36	8.59	7.80	8.15	7.73	8.49
320	9.02	8.37	8.99	9.17	8.36	8.57	7.80	8.14	7.72	8.47
325	9.02	8.35	8.95	9.15	8.34	8.56	7.80	8.10	7.72	8.49
330	9.00	8.33	8.97	9.13	8.34	8.55	7.79	8.11	7.71	8.48
335	8.99	8.32	8.93	9.11	8.32	8.53	7.79	8.13	7.71	8.51
340	8.97	8.30	8.82	9.09	8.31	8.52	7.79	8.16	7.70	8.50
345	8.92	8.27	8.88	9.07	8.30	8.50	7.78	7.91	7.70	8.49
350	8.88	8.26	8.85	9.06	8.29	8.50	7.77	8.10	7.70	8.49
355	8.88	8.24	8.84	9.04	8.27	8.48	7.77	8.19	7.69	8.54
360	8.87	8.21	8.84	9.02	8.26	8.48	7.77	8.12	7.69	8.54
365	8.80	8.19	8.83	9.00	8.25	8.46	7.77	8.12	7.69	8.47
370	8.76	8.18	8.86	8.99	8.24	8.46	7.77	8.10	7.68	8.54
375	8.84	8.16	8.85	8.97	8.22	8.44	7.76	8.15	7.68	8.46

Average pH at different Arbitrary Concentrations and 120mg Orlistat (+/- 0.02)

Time (Sec)	100	90	80	70	60	50	40	30	20	10
380	8.78	8.14	8.78	8.96	8.21	8.43	7.76	8.17	7.68	8.47
385	8.81	8.12	8.74	8.94	8.20	8.42	7.76	8.10	7.68	8.51
390	8.72	8.12	8.72	8.93	8.19	8.41	7.76	8.12	7.67	8.50
395	8.78	8.09	8.71	8.91	8.17	8.40	7.75	8.15	7.67	8.43
400	8.76	8.08	8.72	8.90	8.16	8.39	7.75	8.06	7.67	8.45
405	8.73	8.07	8.67	8.89	8.15	8.39	7.75	8.12	7.67	8.44
410	8.71	8.05	8.70	8.88	8.13	8.38	7.75	8.11	7.66	8.43
415	8.67	8.03	8.64	8.86	8.12	8.36	7.75	7.93	7.66	8.50
420	8.73	8.03	8.68	8.84	8.11	8.36	7.75	8.07	7.66	8.50
425	8.70	8.01	8.64	8.84	8.10	8.36	7.75	8.09	7.65	8.49
430	8.66	7.99	8.49	8.82	8.09	8.35	7.75	8.08	7.65	8.47
435	8.67	7.99	8.54	8.81	8.08	8.34	7.75	8.09	7.65	8.44
440	8.58	7.98	8.48	8.80	8.06	8.34	7.75	8.08	7.64	8.45
445	8.66	7.96	8.47	8.79	8.05	8.32	7.75	8.08	7.64	8.45
450	8.62	7.96	8.49	8.78	8.05	8.32	7.74	8.08	7.64	8.54
455	8.68	7.95	8.58	8.76	8.04	8.31	7.75	8.06	7.64	8.49
460	8.60	7.93	8.48	8.76	8.03	8.30	7.74	8.05	7.63	8.35
465	8.59	7.93	8.45	8.75	8.02	8.30	7.74	8.14	7.63	8.34
470	8.58	7.92	8.45	8.73	8.01	8.29	7.74	8.11	7.62	8.37
475	8.62	7.91	8.45	8.73	8.00	8.29	7.74	8.12	7.62	8.42
480	8.60	7.90	8.34	8.72	7.99	8.27	7.74	8.13	7.62	8.42
485	8.59	7.89	8.36	8.71	7.98	8.27	7.74	8.05	7.62	8.44
490	8.53	7.90	8.38	8.70	7.97	8.26	7.73	8.03	7.61	8.33
495	8.51	7.89	8.45	8.69	7.97	8.26	7.74	8.04	7.62	8.31
500	8.54	7.88	8.52	8.68	7.96	8.26	7.73	8.04	7.61	8.30
505	8.49	7.88	8.47	8.67	7.95	8.24	7.73	8.02	7.61	8.29
510	8.50	7.87	8.46	8.66	7.95	8.24	7.73	8.03	7.61	8.33
515	8.50	7.86	8.48	8.65	7.93	8.23	7.73	8.01	7.60	8.34
520	8.46	7.85	8.45	8.64	7.93	8.22	7.73	8.04	7.61	8.32
525	8.42	7.84	8.43	8.63	7.92	8.21	7.73	8.02	7.60	8.30
530	8.45	7.84	8.46	8.62	7.92	8.20	7.72	8.01	7.60	8.33
535	8.54	7.84	8.39	8.61	7.91	8.20	7.72	8.02	7.60	8.36
540	8.48	7.82	8.44	8.61	7.91	8.20	7.72	8.03	7.60	8.40
545	8.47	7.82	8.29	8.60	7.90	8.19	7.72	8.06	7.60	8.42
550	8.40	7.82	8.40	8.59	7.90	8.19	7.72	7.97	7.60	8.41
555	8.37	7.81	8.31	8.58	7.90	8.18	7.72	7.87	7.60	8.34
560	8.37	7.81	8.28	8.58	7.89	8.18	7.72	8.07	7.60	8.35
565	8.28	7.81	8.27	8.56	7.89	8.18	7.72	8.02	7.59	8.34

Average pH at different Arbitrary Concentrations and 120mg Orlistat (+/- 0.02)

Time (Sec)	100	90	80	70	60	50	40	30	20	10
570	8.20	7.80	8.30	8.56	7.88	8.17	7.72	8.05	7.60	8.35
575	8.30	7.80	8.27	8.55	7.88	8.16	7.72	8.08	7.59	8.33
580	8.40	7.79	8.28	8.54	7.88	8.16	7.71	8.06	7.59	8.30
585	8.38	7.79	8.34	8.54	7.87	8.16	7.71	8.05	7.59	8.33
590	8.35	7.78	8.35	8.53	7.87	8.15	7.71	8.00	7.59	8.33
595	8.40	7.77	8.34	8.52	7.87	8.13	7.70	8.06	7.59	8.33
600	8.32	7.77	8.33	8.51	7.86	8.13	7.70	8.05	7.59	8.30
605	8.33	7.77	8.30	8.50	7.86	8.12	7.70	8.07	7.58	8.29
610	8.43	7.77	8.31	8.50	7.85	8.12	7.69	8.06	7.58	8.32
615	8.42	7.76	8.29	8.49	7.85	8.12	7.69	8.03	7.58	8.29
620	8.37	7.76	8.21	8.49	7.84	8.12	7.69	8.09	7.57	8.30
625	8.33	7.75	8.31	8.48	7.84	8.12	7.69	8.03	7.58	8.31
630	8.35	7.75	8.26	8.47	7.84	8.11	7.69	8.10	7.57	8.34
635	8.34	7.75	8.29	8.47	7.84	8.10	7.69	8.11	7.57	8.26
640	8.43	7.75	8.32	8.46	7.83	8.09	7.68	8.12	7.57	8.24
645	8.32	7.74	8.37	8.45	7.82	8.09	7.68	8.09	7.56	8.20
650	8.30	7.74	8.26	8.45	7.82	8.10	7.68	8.05	7.56	8.23
655	8.19	7.73	8.30	8.45	7.82	8.09	7.68	8.09	7.56	8.25
660	8.41	7.73	8.28	8.43	7.82	8.09	7.68	8.11	7.56	8.20
665	8.38	7.73	8.30	8.43	7.82	8.08	7.68	8.11	7.56	8.28
670	8.44	7.72	8.28	8.43	7.82	8.07	7.68	8.06	7.56	8.26
675	8.54	7.72	8.29	8.41	7.82	8.08	7.68	8.04	7.55	8.31
680	8.40	7.71	8.27	8.41	7.81	8.06	7.68	8.10	7.55	8.37
685	8.41	7.70	8.23	8.40	7.82	8.07	7.67	8.07	7.55	8.34
690	8.36	7.71	8.27	8.40	7.81	8.05	7.67	8.03	7.55	8.26
695	8.38	7.70	8.24	8.39	7.80	8.06	7.67	8.05	7.55	8.31
700	8.51	7.71	8.39	8.39	7.80	8.05	7.67	7.97	7.55	8.24
705	8.47	7.69	8.40	8.39	7.80	8.05	7.67	7.96	7.54	8.20
710	8.40	7.69	8.28	8.38	7.81	8.05	7.67	7.97	7.54	8.15
715	8.40	7.68	8.29	8.37	7.80	8.05	7.66	8.00	7.54	8.26
720	8.41	7.69	8.39	8.36	7.80	8.04	7.66	8.01	7.53	8.38
725	8.45	7.69	8.37	8.36	7.79	8.03	7.66	7.97	7.53	8.40
730	8.40	7.68	8.28	8.36	7.79	8.03	7.65	7.99	7.53	8.39
735	8.52	7.68	8.23	8.35	7.80	8.03	7.65	7.98	7.53	8.43
740	8.52	7.68	8.22	8.35	7.79	8.04	7.65	7.95	7.53	8.37
745	8.53	7.67	8.26	8.34	7.79	8.03	7.64	7.99	7.53	8.17
750	8.48	7.67	8.20	8.34	7.79	8.03	7.64	7.98	7.53	8.06
755	8.39	7.68	8.22	8.33	7.78	8.01	7.64	7.96	7.53	8.34

Average pH at different Arbitrary Concentrations and 120mg Orlistat (+/- 0.02)

Time (Sec)	100	90	80	70	60	50	40	30	20	10
760	8.52	7.67	8.24	8.33	7.78	8.02	7.64	8.03	7.52	8.17
765	8.59	7.67	8.30	8.32	7.78	8.02	7.64	8.05	7.52	8.20
770	8.39	7.66	8.23	8.31	7.77	8.01	7.64	8.03	7.52	8.19
775	8.41	7.66	8.19	8.31	7.78	8.00	7.63	8.00	7.52	8.18
780	8.55	7.66	8.23	8.31	7.78	8.01	7.64	8.04	7.52	8.20
785	8.37	7.67	8.26	8.30	7.77	8.00	7.63	8.01	7.52	8.40
790	8.39	7.66	8.26	8.30	7.77	8.01	7.63	8.00	7.52	8.40
795	8.38	7.65	8.25	8.30	7.77	7.99	7.62	7.96	7.52	8.23
800	8.41	7.66	8.25	8.29	7.77	7.99	7.62	7.96	7.51	8.19
805	8.54	7.65	8.26	8.29	7.77	8.00	7.62	7.98	7.51	8.36
810	8.36	7.65	8.28	8.29	7.77	7.99	7.63	7.96	7.51	8.16
815	8.15	7.65	8.26	8.27	7.76	7.99	7.62	7.97	7.50	8.17
820	8.14	7.64	8.34	8.28	7.77	7.98	7.62	7.96	7.50	8.16
825	8.14	7.65	8.32	8.27	7.76	7.99	7.62	7.98	7.50	8.17
830	8.34	7.63	8.29	8.27	7.76	7.98	7.62	7.98	7.50	8.27
835	8.32	7.63	8.29	8.26	7.76	7.98	7.61	7.99	7.49	8.24
840	8.32	7.63	8.28	8.26	7.76	7.98	7.61	7.97	7.50	8.16
845	8.33	7.64	8.26	8.26	7.76	7.98	7.61	7.96	7.50	8.13
850	8.31	7.63	8.25	8.25	7.76	7.97	7.60	7.99	7.49	8.24
855	8.33	7.62	8.37	8.25	7.76	7.97	7.60	7.94	7.49	8.13
860	8.32	7.63	8.34	8.24	7.75	7.97	7.61	7.97	7.49	8.18
865	8.49	7.62	8.37	8.24	7.75	7.97	7.60	7.96	7.48	8.15
870	8.52	7.63	8.48	8.24	7.75	7.97	7.60	8.02	7.48	8.23
875	8.27	7.62	8.52	8.23	7.75	7.96	7.60	7.97	7.49	8.13
880	8.27	7.61	8.47	8.23	7.75	7.96	7.60	8.00	7.49	8.27
885	8.33	7.61	8.33	8.22	7.75	7.96	7.60	8.00	7.48	8.13
890	8.31	7.60	8.34	8.22	7.75	7.96	7.59	7.98	7.48	8.28
895	8.26	7.62	8.42	8.21	7.75	7.96	7.59	7.99	7.49	8.16
900	8.30	7.61	8.41	8.22	7.75	7.95	7.60	8.00	7.48	8.27

The following table shows the results of the experiment. The first column is the number of trials, the second column is the number of correct responses, and the third column is the percentage of correct responses. The data shows that the number of correct responses increases as the number of trials increases, and the percentage of correct responses remains relatively constant around 75%.

Number of Trials	Number of Correct Responses	Percentage of Correct Responses
10	7	70%
20	15	75%
30	22	73%
40	30	75%
50	38	76%
60	45	75%
70	52	74%
80	60	75%
90	68	76%
100	75	75%

Appendix Two

1000
1000
1000
1000
1000

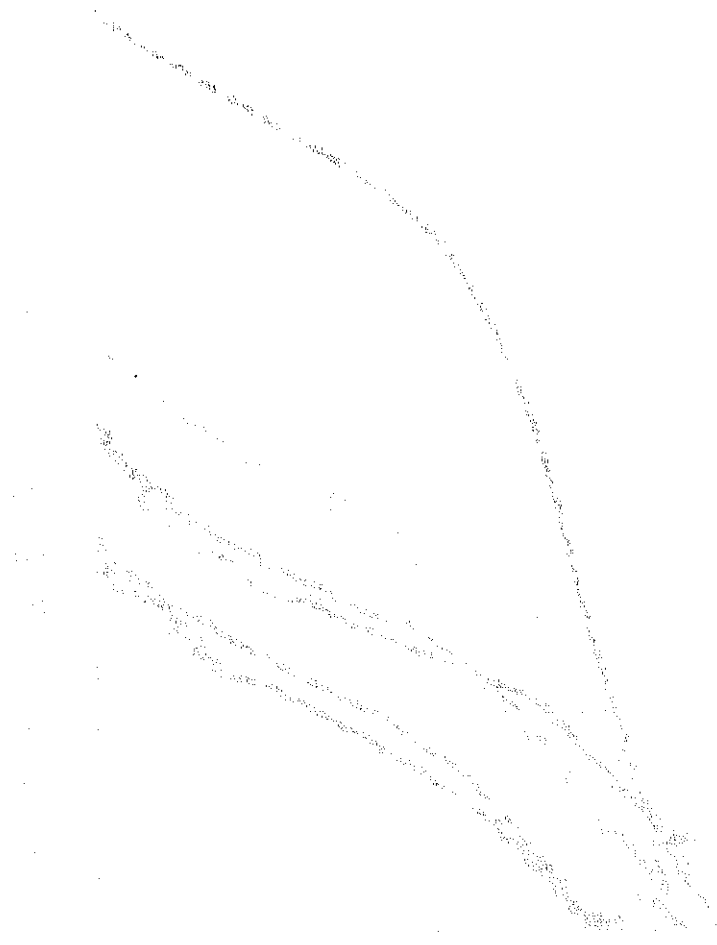

1000
1000
1000
1000
1000

1000
1000
1000
1000
1000

Graph 1.2

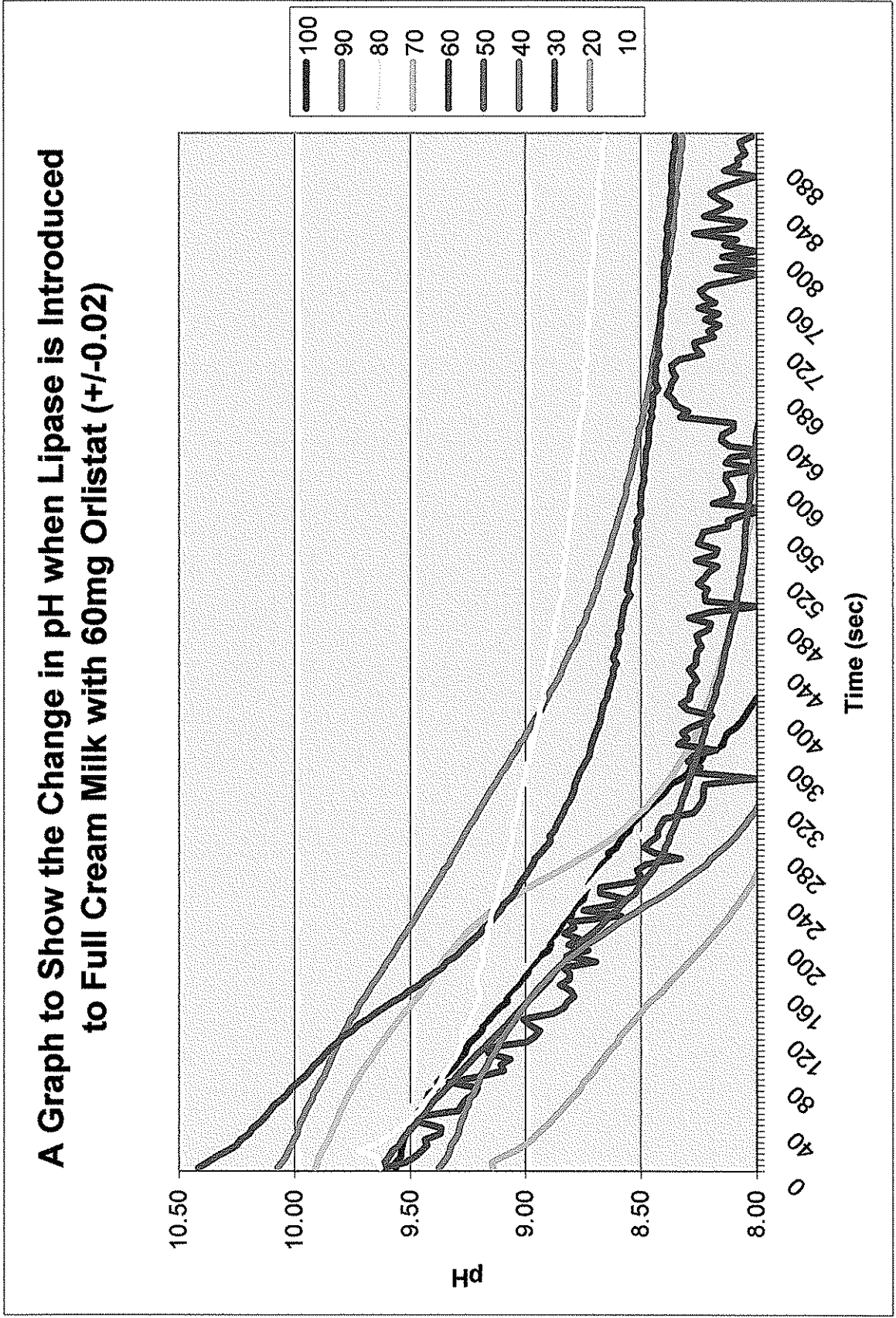

1000
100
10
1
0.1
0.01

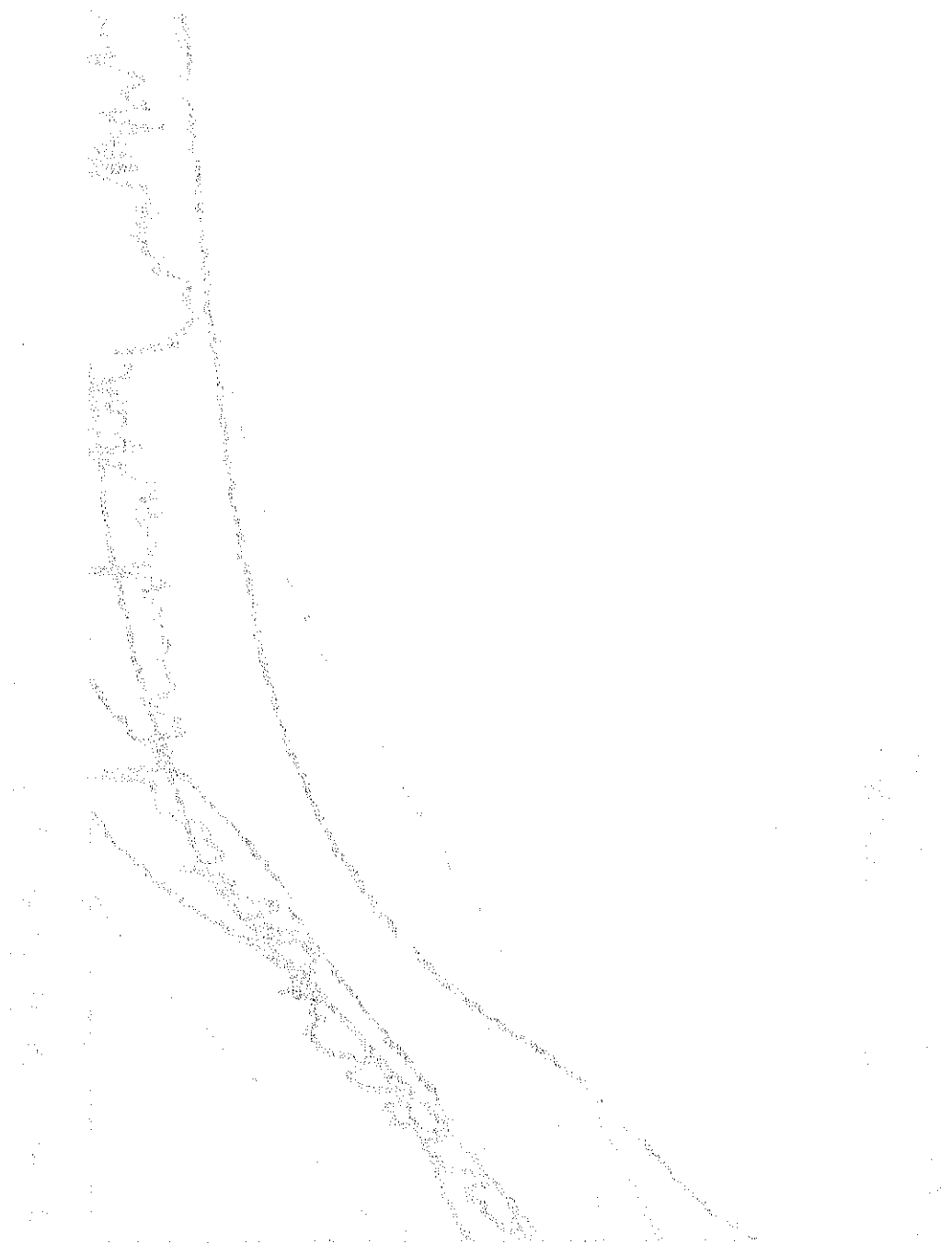

Graph 1.3

A Graph to Show the Change in pH when Lipase is Introduced to Full Cream Milk with 120mg Orlistat (± 0.02)



1000
1000
1000
1000



1000
1000
1000
1000

Assessment form (for examiner use only)

Candidate session number	0	0							
--------------------------	---	---	--	--	--	--	--	--	--

Assessment criteria		Achievement level		
		First examiner	maximum	Second examiner
A	research question	2 ✓	2	<input type="checkbox"/>
B	introduction	2 ✓	2	<input type="checkbox"/>
C	investigation	3 ✓	4	<input type="checkbox"/>
D	knowledge and understanding	2 ✓	4	<input type="checkbox"/>
E	reasoned argument	3 ✓	4	<input type="checkbox"/>
F	analysis and evaluation	3 ✓	4	<input type="checkbox"/>
G	use of subject language	2 ✓	4	<input type="checkbox"/>
H	conclusion	2 ✓	2	<input type="checkbox"/>
I	formal presentation	2 ✓	4	<input type="checkbox"/>
J	abstract	2 ✓	2	<input type="checkbox"/>
K	holistic judgment	3 ✓	4	<input type="checkbox"/>
Total out of 36		26 ✓		<input type="checkbox"/>

Name of first examiner: _____
(CAPITAL letters)

Examiner number: _____

Name of second examiner: _____
(CAPITAL letters)

Examiner number: _____

